

## NZASB EXPOSURE DRAFT 2018-4

### **PUBLIC BENEFIT ENTITY INTERNATIONAL PUBLIC SECTOR ACCOUNTING STANDARD 40 PBE COMBINATIONS (PBE IPSAS 40)**

#### **Issued [Date]**

This [draft]<sup>1</sup> Standard was issued on [date] by the New Zealand Accounting Standards Board of the External Reporting Board pursuant to section 12(a) of the Financial Reporting Act 2013.

This [draft] Standard is a disallowable instrument for the purposes of the Legislation Act 2012, and pursuant to section 27(1) of the Financial Reporting Act 2013 takes effect on [date].

Reporting entities that are subject to this [draft] Standard are required to apply the [draft] Standard in accordance with the effective date set out in paragraph 126.1.

In finalising this [draft] Standard, the New Zealand Accounting Standards Board has carried out appropriate consultation in accordance with section 22(1) of the Financial Reporting Act 2013.

This [draft] New Zealand Tier 1 and Tier 2 Public Benefit Entity Accounting Standard has been issued as a result of a new International Public Sector Accounting Standard, IPSAS 40 *Public Sector Combinations*.

This [draft] Standard when applied, supersedes PBE IFRS 3 *Business Combinations*.

---

<sup>1</sup> References to “this Standard” throughout this Exposure Draft should be read as referring to “this draft Standard”.

## **PBE IPSAS 40 PBE COMBINATIONS**

### **COPYRIGHT**

© External Reporting Board (XRB) 2018

This XRB standard contains copyright material and reproduces, with the permission of the International Federation of Accountants (IFAC), parts of the corresponding international standard issued by the International Public Sector Accounting Standards Board (IPSASB), and published by IFAC. Reproduction within New Zealand in unaltered form (retaining this notice) is permitted for personal and non-commercial use subject to the inclusion of an acknowledgement of the source.

Requests and enquiries concerning reproduction and rights for commercial purposes within New Zealand should be addressed to the Chief Executive, External Reporting Board at the following email address: [enquiries@xrb.govt.nz](mailto:enquiries@xrb.govt.nz)

All existing rights (including copyrights) in this material outside of New Zealand are reserved by IFAC, with the exception of the right to reproduce for the purposes of personal use or other fair dealing. Further information can be obtained from IFAC at [www.ifac.org](http://www.ifac.org) or by writing to [permissions@ifac.org](mailto:permissions@ifac.org)

ISBN

# PBE IPSAS 40—PBE COMBINATIONS

## CONTENTS

	from paragraph
Objective .....	1
Scope .....	1.1
Definitions .....	5
Identifying a PBE Combination .....	6
Classification of PBE Combinations .....	7
Indicators that May Provide Evidence that the Combination is an Amalgamation .....	12
Accounting for Amalgamations .....	15
The Modified Pooling of Interests Method of Accounting .....	16
Identifying the Resulting Entity .....	17
Determining the Amalgamation Date .....	19
Recognising and Measuring the Assets Received, Liabilities Assumed and any Non-Controlling Interests in the Combining Operations .....	20.1
Recognising and Measuring Components of Net Assets/Equity Arising as a Result of an Amalgamation .....	36
Measurement Period .....	40
Amalgamation-Related Costs .....	45
Subsequent Measurement and Accounting .....	46
Presentation of Financial Statements .....	50
Disclosures .....	53
Accounting for Acquisitions .....	58
The Acquisition Method of Accounting .....	59
Identifying the Acquirer .....	60
Determining the Acquisition Date .....	62
Recognising and Measuring the Identifiable Assets Acquired, the Liabilities Assumed and any Non-Controlling Interest in the Acquired Operation .....	64
Recognising and Measuring Goodwill or a Gain from a Bargain Purchase .....	85
An Acquisition Achieved in Stages .....	99
Additional Guidance for Applying the Acquisition Method where an Acquisition is Achieved Through Changes in Voting Rights, by Contract Alone, and Similar Circumstances in which no Consideration is Transferred .....	101
Measurement Period .....	103
Determining what is Part of the Acquisition Transaction .....	109
Subsequent Measurement and Accounting .....	112
Disclosures .....	119
Effective Date and Transition .....	126
Effective Date .....	126
Transition .....	134.1

Withdrawal and Replacement of PBE IFRS 3 (2014) .....	134.4
Appendix A: Application Guidance	
Appendix B: Amendments to Other Standards	
Basis for Conclusions	
IPSASB Basis for Conclusions <sup>2</sup>	
Implementation Guidance	
Illustrative Examples	
Comparison with IPSAS 40	
History of Amendments	

---

Public Benefit Entity International Public Sector Accounting Standard 40 *PBE Combinations* is set out in paragraphs 1–134.4 and Appendices A and B. All the paragraphs have equal authority. PBE IPSAS 40 should be read in the context of its objective, the NZASB’s Basis for Conclusions on PBE IPSAS 40, the IPSASB’s Basis for Conclusions on IPSAS 40, the *Public Benefit Entities’ Conceptual Framework* and Standard XRB A1 *Application of the Accounting Standards Framework*. PBE IPSAS 3 *Accounting Policies, Changes in Accounting Estimates and Errors* provides a basis for selecting and applying accounting policies in the absence of explicit guidance.

---

<sup>2</sup> For the purpose of this Exposure Draft, the IPSASB’s Basis for Conclusions has been included. When the PBE Standard is issued, the IPSASB’s Basis for Conclusions will be made available as additional material on the XRB website.

## Objective

1. The objective of this Standard is to improve the relevance, faithful representativeness and comparability of the information that a reporting entity provides in its financial statements about a public benefit entity (PBE) combination and its effects. To accomplish that, this Standard establishes principles and requirements for how:
  - (a) A reporting entity classifies a PBE combination as an amalgamation or an acquisition;
  - (b) A resulting entity recognises and measures in its financial statements the assets received, the liabilities assumed and any non-controlling interest in an amalgamation;
  - (c) A resulting entity recognises and measures components of net assets/equity and other adjustments recognised in an amalgamation;
  - (d) An acquirer recognises and measures in its financial statements the identifiable assets acquired, the liabilities assumed and any non-controlling interest in the acquired operation;
  - (e) An acquirer recognises and measures the goodwill acquired in, or the gain or loss arising from, an acquisition; and
  - (f) A reporting entity determines what information to disclose to enable users of the financial statements to evaluate the nature and financial effects of a PBE combination.

## Scope

- 1.1 **This Standard applies to Tier 1 and Tier 2 public benefit entities.**
- 1.2 **A Tier 2 entity is not required to comply with the requirements in this Standard denoted with an asterisk (\*). Where a Tier 2 entity elects to apply a disclosure concession it shall comply with any RDR paragraphs associated with that concession.**
2. **An entity that prepares and presents financial statements shall apply this Standard in accounting for PBE combinations.**
3. **This Standard applies to a transaction or other event that meets the definition of a PBE combination. This Standard does not apply to:**
  - (a) **The accounting for the formation of a joint arrangement in the financial statements of the joint arrangement itself.**
  - (b) **The acquisition or receipt of an asset or a group of assets (and any related liabilities) that does not constitute an operation. In such cases an entity shall identify and recognise the individual identifiable assets acquired or received (including those assets that meet the definition of, and recognition criteria for, intangible assets in PBE IPSAS 31 *Intangible Assets*) and liabilities assumed. Such a transaction or event does not give rise to goodwill.**
  - (c) **The assumption of a liability or a group of liabilities that does not constitute an operation. In such cases an entity shall identify and recognise the individual liabilities assumed.**
4. **The requirements of this Standard do not apply to the acquisition by an investment entity, as defined in PBE IPSAS 35 *Consolidated Financial Statements*, of an investment in a controlled entity that is required to be measured at fair value through surplus or deficit.**

## Definitions

5. The following terms are used in this Standard with the meanings specified:

**Public benefit entities** are reporting entities whose primary objective is to provide goods or services for community or social benefit and where any equity has been provided with a view to supporting that primary objective rather than for a financial return to equity holders.

**A public benefit entity (PBE) combination** is the bringing together of separate operations into one public benefit entity.

*General definitions related to all PBE combinations*

For the purposes of this Standard, **equity interests** is used broadly to mean ownership interests of investor-owned entities and owner, member or participant interests of mutual entities. In the context of this Standard equity interests may also mean ownership interests established by other mechanisms such as deed or statute.

An asset is **identifiable** if it either:

- (a) Is separable, i.e., is capable of being separated or divided from the entity and sold, transferred, licensed, rented, or exchanged, either individually or together with a related binding arrangement, identifiable asset or liability, regardless of whether the entity intends to do so; or
- (b) Arises from binding arrangements (including rights from contracts or other legal rights), regardless of whether those rights are transferable or separable from the entity or from other rights and obligations.

A **mutual entity** is an entity, other than an investor-owned entity, that provides dividends, lower costs or other economic benefits directly to its owners, members or participants. For example, a mutual insurance company, a credit union and a co-operative entity are all mutual entities.

An **operation** is an integrated set of activities and related assets and/or liabilities that is capable of being conducted and managed for the purpose of achieving an entity's objectives, by providing goods and/or services for community or social benefit, rather than a financial return to equity holders. In the context of this Standard, "operation" also includes an integrated set of activities that is capable of being conducted and managed for the purpose of providing a return in the form of dividends, lower costs or other economic benefits directly to investors or other owners, members or participants.

For the purposes of this Standard, **owners** is used broadly to include those with an equity interest. This includes, but is not limited to, those with an equity interest in investor-owned entities and owners or members of, or participants in, mutual entities.

A **PBE combination under common control** is a PBE combination in which all of the entities or operations involved are ultimately controlled by the same entity both before and after the PBE combination.

*Definitions related to amalgamations*

An **amalgamation** gives rise to a resulting entity and is either:

- (a) A PBE combination in which no party to the combination gains control of one or more operations; or
- (b) A PBE combination in which one party to the combination gains control of one or more operations, and in which there is evidence that the combination has the economic substance of an amalgamation.

The **amalgamation date** is the date on which the resulting entity obtains control of the combining operations.

A **combining operation** is an operation that combines with one or more other operations to form the resulting entity in an amalgamation.

A **resulting entity** is the entity that is the result of two or more operations combining in an amalgamation.

*Definitions relating to acquisitions*

An **acquired operation** is the operation that the acquirer gains control of in an acquisition.

An **acquirer** is the entity that gains control of one or more operations in an acquisition.

An **acquisition** is a PBE combination in which one party to the combination gains control of one or more operations, and there is evidence that the combination is not an amalgamation.

The **acquisition date** is the date on which the acquirer gains control of the acquired operation.

**Contingent consideration** is usually an obligation of the acquirer to transfer additional assets or equity interests to the former owners of an acquired operation as part of the exchange for control of the acquired operation if specified future events occur or conditions are met. However, contingent consideration also may give the acquirer the right to the return of previously transferred consideration if specified conditions are met.

**Goodwill** is an asset representing the future economic benefits arising from other assets acquired in an acquisition that are not individually identified and separately recognised.

Terms defined in other PBE Standards are used in this Standard with the same meaning as in those Standards, and are reproduced in the *Glossary of Defined Terms* published separately.

## Identifying a PBE Combination

6. An entity shall determine whether a transaction or other event is a PBE combination by applying the definitions in this Standard, which requires that the assets and liabilities constitute an operation. If the assets and liabilities do not constitute an operation, the entity shall account for the transaction or other event in accordance with other PBE Standards. Paragraphs AG2–AG9 provide guidance on identifying a PBE combination.

## Classification of PBE Combinations

7. If no party to a PBE combination gains control of one or more operations as a result of the combination, the combination shall be classified as an amalgamation. Paragraphs AG10–AG18 provide guidance on determining whether one party to a PBE combination gains control of one or more operations as a result of that combination.
8. If one party to a PBE combination gains control of one or more operations as a result of the combination, an entity shall consider the economic substance of the combination in classifying the combination as either an amalgamation or an acquisition. A combination in which one party gains control of one or more operations shall be classified as an acquisition, unless it has the economic substance of an amalgamation.
9. In determining the classification of the PBE combination, an entity considers whether the resulting accounting treatment of the combination provides information that meets the objectives of financial reporting and that satisfies the qualitative characteristics (QCs). To assess the economic substance of the combination, an entity considers the indicators relating to consideration and to the decision-making process in paragraphs 12–13. These indicators, individually or in combination, will usually provide evidence that the economic substance of the combination is that of an amalgamation. A combination does not need to satisfy both of these indicators to be classified as an amalgamation. Paragraphs AG19–AG39 provide additional guidance.
10. An analysis of the indicators relating to consideration and to the decision-making process in paragraphs 12–13 will usually produce a conclusive result and provide sufficient evidence about the economic substance of the PBE combination to determine whether the combination is an amalgamation. In such circumstances, the resulting classification and the associated accounting treatment will ensure that users have access to information that meets the objectives of financial reporting and that satisfies the QCs.
11. In exceptional circumstances, after applying the indicators in paragraphs 12–13, the results may be inconclusive or may not provide sufficient evidence about the economic substance of the PBE combination. In such circumstances, an entity also considers which classification would provide information that best meets the objectives of financial reporting and that best satisfies the QCs, having regard to paragraph 14. Paragraphs AG40–AG41 provide additional guidance.

## Indicators that May Provide Evidence that the Combination is an Amalgamation

### *Indicator Relating to Consideration*

12. The absence of consideration paid to compensate those with an entitlement to the net assets of a transferred operation for giving up that entitlement may provide evidence that the combination is an amalgamation if the reasons for the absence of consideration do not provide evidence of an acquisition (paragraphs AG26–AG30 provide additional guidance).

(a) – (c) [Not used]

*Indicators Relating to the Decision-Making Process*

13. The following indicators may provide evidence that the combination is an amalgamation:
- (a) A PBE combination is imposed by a third party without any party to the combination being involved in the decision-making process (paragraphs AG32–AG35 provide additional guidance);
  - (b) A PBE combination is subject to approval by each party’s citizens through referenda (paragraph AG36 provides additional guidance); or
  - (c) A PBE combination under common control occurs (paragraphs AG37–AG39 provide additional guidance).

*Additional matters to be taken into account where the indicators relating to consideration and the decision-making process do not provide sufficient evidence to determine whether the combination is an amalgamation*

14. The analysis of the indicators relating to consideration and the decision-making process may, in exceptional circumstances, produce inconclusive results or not provide sufficient evidence to determine whether the combination is an amalgamation, based on the economic substance of the PBE combination and the indicators in paragraphs 12–13. In such circumstances, an entity considers which classification and resulting accounting treatment would provide information that best meets the objectives of financial reporting. Paragraphs AG42–AG46 provide additional guidance. An entity also considers which classification and resulting accounting treatment would provide information that best satisfies the QCs of relevance, faithful representation, understandability, timeliness, comparability and verifiability. Paragraphs AG47–AG50 provide additional guidance.

**Accounting for Amalgamations**

15. **A resulting entity shall account for each amalgamation by applying the modified pooling of interests method of accounting.**

**The Modified Pooling of Interests Method of Accounting**

16. Applying the modified pooling of interests method of accounting requires:
- (a) Identifying the resulting entity;
  - (b) Determining the amalgamation date;
  - (c) Recognising and measuring the assets received, the liabilities assumed and any non-controlling interest in the combining operations, consistent with the requirements in PBE Standards; and
  - (d) Recognising and measuring the components of net assets/equity and other adjustments from an amalgamation.

**Identifying the Resulting Entity**

17. **For each amalgamation, a resulting entity shall be identified.**
18. Paragraph 5 defines a resulting entity as “the entity that is the result of two or more operations combining in an amalgamation.” As explained in paragraph 8, one of the parties to the amalgamation may have gained control of one or more of the combining operations. The existence or absence of control determines whether the resulting entity is a new reporting entity or a continuing reporting entity. When none of the parties to the combination that existed prior to the combination gain control over the combining operations, the resulting entity is a new reporting entity. When one of the parties to the combination that existed prior to the combination gains control of the other combining operations, the resulting entity is that continuing reporting entity.

**Determining the Amalgamation Date**

19. **The resulting entity shall identify the amalgamation date, which is the date on which it obtains control of the combining operations.**
20. The date on which the resulting entity obtains control of the combining operations may be the date on which the resulting entity receives the assets and assumes the liabilities of the combining operations. It is possible that the resulting entity will not receive legal title to the assets or assume legal responsibility for



the liabilities of the combining operations. In these circumstances, the resulting entity will often obtain control of the assets and liabilities of the combining operations on the date on which responsibility for the assets and liabilities is formally delegated to the resulting entity. However, the resulting entity might obtain control on a different date. A resulting entity shall consider all pertinent facts and circumstances in identifying the amalgamation date.

### **Recognising and Measuring the Assets Received, Liabilities Assumed and any Non-Controlling Interests in the Combining Operations**

#### *Recognition Principle*

- 20.1 **If, prior to the amalgamation date, all of the combining operations have previously applied PBE Standards, then the resulting entity shall apply paragraphs 21–35. If, prior to the amalgamation date, one or more of the combining operations have not previously applied PBE Standards, then the resulting entity shall apply paragraphs 21–35 and paragraphs AG50.1–AG50.2.**
21. **As of the amalgamation date, the resulting entity shall, in accordance with PBE Standards, recognise in the combined operation’s financial statements the assets, liabilities and any non-controlling interests of the combining operations as of the amalgamation date. Recognition of assets received and liabilities assumed is subject to the conditions specified in paragraph 22 and the exceptions specified in paragraph 31.**

#### *Recognition Condition*

22. **The effects of all transactions between the combining operations are eliminated in preparing the financial statements of the resulting entity (paragraphs AG51–AG52 provide related application guidance).**
23. [Not used]

#### *Classifying or Designating Assets and Liabilities in an Amalgamation*

24. **At the amalgamation date, the resulting entity shall classify or designate the assets and liabilities received in an amalgamation using the classifications or designations previously applied by the combining operations. A resulting entity shall not adopt different classifications or designations on initial recognition, unless required to do so by other PBE Standards.**
25. In some situations, PBE Standards provide for different accounting depending on how an entity classifies or designates a particular asset or liability. Examples of classifications or designations that the resulting entity shall make on the basis of the classifications or designations previously applied by the combining operations include, but are not limited to:
- (a) Classification of particular financial assets and liabilities as measured at fair value or at amortised cost, in accordance with PBE IPSAS 29 *Financial Instruments: Recognition and Measurement*;<sup>3</sup>
  - (b) Designation of a derivative instrument as a hedging instrument in accordance with PBE IPSAS 29; and
  - (c) Assessment of whether an embedded derivative should be separated from a host contract in accordance with PBE IPSAS 29 (which is a matter of ‘classification’ as this Standard uses that term).

#### *Measurement Principle*

26. **The resulting entity shall measure the assets and liabilities of the combining operations at their carrying amounts in the financial statements of the combining operations as of the amalgamation date, subject to the requirements of paragraph 27 (paragraph AG54 provides related application guidance) and the exceptions specified in paragraph 31.**

<sup>3</sup> If an entity applies this Standard and early adopts PBE IFRS 9 *Financial Instruments*, the references to PBE IPSAS 29 in this paragraph shall be read as references to PBE IFRS 9, including the classification of financial assets and financial liabilities in accordance with PBE IFRS 9.

27. **As of the amalgamation date, the resulting entity shall adjust the carrying amounts of the assets and liabilities of the combining operations where required to conform to the resulting entity's accounting policies.**
28. The modified pooling of interests method results in a single combined resulting entity. A single uniform set of accounting policies, consistent with the requirements of PBE Standards, is adopted by that entity, and the carrying amounts of the assets and liabilities of the combining operations are adjusted, where required, to conform to those accounting policies (paragraphs AG54.1–AG54.2 provide related application guidance).
29. The resulting entity shall measure any non-controlling interests in a combining operation at their carrying amounts in the financial statements of that combining operation as of the amalgamation date, adjusted for the non-controlling interests' proportionate share of the adjustments made in accordance with paragraph 27.
30. Paragraphs 33–35 specify the types of assets and liabilities that include items for which this Standard provides limited exceptions to the measurement principle.

*Exceptions to the Recognition or Measurement Principles*

31. This Standard provides limited exceptions to its recognition and measurement principles. Paragraphs 32–35 specify both the particular items for which exceptions are provided and the nature of those exceptions. The resulting entity shall account for those items by applying the requirements in paragraphs 32–35, which will result in some items being:
  - (a) Recognised either by applying recognition conditions in addition to those in paragraph 22 or by applying the requirements of other PBE Standards, with results that differ from applying the recognition principle and conditions.
  - (b) Measured at an amount other than their amalgamation date carrying amounts.

Exception to the Recognition Principle

*Licences and Similar Rights Previously Granted by One Combining Operation to Another Combining Operation*

32. A licence or similar right, previously granted by one combining operation to another combining operation and recognised as an intangible asset by the recipient combining operation shall be recognised by the resulting entity as an intangible asset. The licence or similar right shall not be eliminated in accordance with paragraph 22 (paragraphs AG55–AG56 provide related application guidance).

Exceptions to both the Recognition and Measurement Principles

*Income Taxes (where Included in the Terms of the Amalgamation)*

33. Amalgamations involving public sector entities may result in a tax authority forgiving amounts of tax due as part of the terms of the amalgamation. The resulting entity shall not recognise any taxation items that are forgiven as a result of the terms of the amalgamation (paragraph AG57 provide related application guidance).
34. [Not used]

Employee Benefits

35. The resulting entity shall recognise and measure a liability (or asset, if any) related to the combining operations' employee benefit arrangements in accordance with PBE IPSAS 39 *Employee Benefits*.

**Recognising and Measuring Components of Net Assets/Equity Arising as a Result of an Amalgamation**

36. **An amalgamation does not give rise to goodwill (paragraphs AG59–AG60 provide related application guidance).**

37. **The resulting entity shall recognise within net assets/equity the aggregate of:**
- (a) **The carrying amounts of the combining operations' assets;<sup>4</sup>**
  - (b) **The carrying amounts of the combining operations' liabilities; and**
  - (c) **The carrying amounts of the combining operations' non-controlling interests.**
38. **The resulting entity shall recognise within net assets/equity the corresponding adjustments in respect of:**
- (a) **The elimination of transactions between combining operations in accordance with paragraph 22;**
  - (b) **Adjustments made to the carrying amounts of the assets and liabilities of the combining operations where required to conform to the resulting entity's accounting policies, in accordance with paragraph 27; and**
  - (c) **Adjustments made in respect of the exceptions to the recognition and/or measurement principles, in accordance with paragraphs 32–35.**
39. **The resulting entity may present the amounts recognised within net assets/equity in accordance with paragraphs 37 and 38 as either:**
- (a) **A single opening balance; or**
  - (b) **As separate opening balances of components of net assets/equity, including any components of the combining operations retained by the resulting entity.**

#### **Measurement Period**

40. **If the initial accounting for an amalgamation is incomplete by the end of the reporting period in which the amalgamation occurs, the resulting entity shall report in its financial statements provisional amounts for the items for which the accounting is incomplete. During the measurement period, the resulting entity shall retrospectively adjust the provisional amounts recognised at the amalgamation date to reflect new information obtained about facts and circumstances that existed as of the amalgamation date and, if known, would have affected the measurement of the amounts recognised as of that date. During the measurement period, the resulting entity shall also recognise additional assets or liabilities if new information is obtained about facts and circumstances that existed as of the amalgamation date and, if known, would have resulted in the recognition of those assets and liabilities as of that date. The measurement period ends as soon as the resulting entity receives the information it was seeking about facts and circumstances that existed as of the amalgamation date or learns that more information is not obtainable. However, the measurement period shall not exceed one year from the amalgamation date.**
41. The measurement period is the period after the amalgamation date during which the resulting entity may adjust the provisional amounts recognised for an amalgamation. The measurement period provides the resulting entity with a reasonable time to obtain the information necessary to identify and measure the assets, liabilities and any non-controlling interest in the combining operations as of the amalgamation date in accordance with the requirements of this Standard. The information necessary to identify and measure the assets, liabilities and any non-controlling interest in the combining operations will generally be available at the amalgamation date. However, this may not be the case where combining operations have previously prepared their financial statements using different accounting policies.
42. The resulting entity recognises an increase (decrease) in the provisional amount recognised for an asset (liability) by adjusting components of net assets/equity recognised in accordance with paragraphs 37–38. However, new information obtained during the measurement period may sometimes result in an adjustment to the provisional amount of more than one asset or liability. For example, the resulting entity might have assumed a liability to pay damages related to an accident in one of the combining operation's facilities, part or all of which is covered by the combining operation's liability insurance policy. If the resulting entity obtains new information during the measurement period about the carrying amount of that liability, the

---

<sup>4</sup> In this paragraph the term "combining operations" refers to the operations being combined into the resulting entity rather than those that belong to the continuing reporting entity or new reporting entity.

adjustment to the gain or loss resulting from a change to the provisional amount recognised for the liability would be offset (in whole or in part) by a corresponding adjustment to the gain or loss resulting from a change to the provisional amount recognised for the claim receivable from the insurer.

43. During the measurement period, the resulting entity shall recognise adjustments to the provisional amounts as if the accounting for the amalgamation had been completed at the amalgamation date. Thus, the resulting entity shall revise comparative information for prior periods presented in financial statements as needed, including making any change in depreciation or amortisation recognised in completing the initial accounting.
44. After the measurement period ends, the resulting entity shall revise the accounting for an amalgamation only to correct an error in accordance with PBE IPSAS 3 *Accounting Policies, Changes in Accounting Estimates and Errors*.

#### **Amalgamation-Related Costs**

45. Amalgamation-related costs are costs the resulting entity or combining operations incur to effect an amalgamation. Those costs include advisory, legal, accounting, valuation and other professional or consulting fees; general administrative costs; and any costs of registering and issuing debt and equity securities. The resulting entity and combining operations shall account for amalgamation-related costs as expenses in the periods in which the costs are incurred and the services are received, with one exception. The costs to issue debt or equity securities shall be recognised in accordance with PBE IPSAS 28 *Financial Instruments: Presentation*, and PBE IPSAS 29.<sup>5</sup>

#### **Subsequent Measurement and Accounting**

46. In general, a resulting entity shall subsequently measure and account for assets and liabilities received and equity instruments issued in an amalgamation in accordance with other applicable PBE Standards for those items, depending on their nature. However, this Standard provides guidance on subsequently measuring and accounting for the following assets received and liabilities assumed or incurred in an amalgamation:
- (a) Licenses and similar rights previously granted by one combining operation to another combining operation;
  - (b) Transfers, concessionary loans and similar benefits received by a combining operation on the basis of criteria that change as a result of an amalgamation; and
  - (c) Income taxes (where not included in the terms of the amalgamation).

#### *Licences and Similar Rights Previously Granted by One Combining Operation to Another Combining Operation*

47. A licence or similar right, previously granted by one combining operation to another combining operation and recognised as an intangible asset shall be amortised over the remaining period of the binding arrangement in which the right was granted, where the right was granted for a finite period. Where the right was granted for an indefinite period, the resulting entity shall test the right for impairment at least annually, and whenever there is an indication that the right may be impaired. A resulting entity that subsequently sells this licence or similar right to a third party shall include the carrying amount of the intangible asset in determining the gain or loss on the sale.

#### *Transfers, Concessionary Loans and Similar Benefits Received by a Combining Operation on the Basis of Criteria that may Change as a Result of an Amalgamation*

48. A transfer, concessionary loan or similar benefit, previously received by a combining operation on the basis of criteria that change as a result of an amalgamation, shall be reassessed prospectively in accordance with other PBE Standards (paragraphs AG61–AG63 provide related application guidance).

---

<sup>5</sup> If an entity applies this Standard and early adopts PBE IFRS 9 *Financial Instruments*, the references to PBE IPSAS 29 in this paragraph shall be read as references to PBE IFRS 9.

*Income Taxes (Where not Included in the Terms of the Amalgamation)*

49. Amalgamations involving public sector entities may result in a tax authority forgiving amounts of tax subsequent to the amalgamation. The resulting entity shall account for the tax forgiven prospectively in accordance with PBE IAS 12 *Income Taxes*.

**Presentation of Financial Statements**

50. **If, following a PBE combination, the resulting entity is a new reporting entity, the resulting entity's first set of financial statements following the amalgamation shall comprise:**

- (a) **An opening statement of financial position as of the amalgamation date;**
- (b) **A statement of financial position as at the reporting date;**
- (c) **A statement of comprehensive revenue and expense for the period from the amalgamation date to the reporting date;**
- (d) **A statement of changes in net assets/equity for the period from the amalgamation date to the reporting date;**
- (e) **A cash flow statement for the period from the amalgamation date to the reporting date;**
- (f) **When a public sector entity has published general purpose prospective financial statements for the period from the amalgamation date to the reporting date, the information specified in paragraph 148.1 of PBE IPSAS 1 *Presentation of Financial Reports* shall be presented on the face of the financial statements or as a separate statement. When a not-for-profit entity has published general purpose prospective financial statements for the period from the amalgamation date to the reporting date, the information specified in paragraph 148.1 of PBE IPSAS 1 shall be presented on the face of the financial statements, as a separate statement or in the notes; and**
- (g) **Notes, comprising a summary of significant accounting policies and other explanatory notes.**

**The resulting entity shall not present comparative information on the face of its financial statements for the periods prior to the amalgamation date. The resulting entity is permitted to disclose in the notes comparative information for the combining operations for the periods prior to the amalgamation date, in accordance with paragraph 54(g).**

51. **If, following a PBE combination, the resulting entity is a continuing reporting entity, the resulting entity shall disclose as of the amalgamation date:**

- (a) **The amounts recognised of each major class of assets and liabilities, and components of net assets/equity from combining operations included in the resulting entity;**
- (b) **Any adjustments made to components of net assets/equity where required to conform the accounting policies of the combining operations with those of the resulting entity; and**
- (c) **Any adjustments made to eliminate transactions between the combining operations.**

**The resulting entity shall present comparative financial information, in respect of the continuing reporting entity only, for the period prior to the amalgamation date on the face of the financial statements but this information shall not be restated. The resulting entity is permitted to disclose in the notes comparative financial information for the combining operations for the periods prior to the amalgamation date, in accordance with paragraph 54(g).**

52. Subject to the requirements in paragraphs 54 and 56, the resulting entity is permitted but not required to present financial statements for one or more of the combining operations for periods prior to the amalgamation date (paragraph AG64 provides related application guidance). Where a resulting entity elects to present financial statements for the combining operations for periods prior to the amalgamation date, it shall disclose the information required by paragraph 54(g). The resulting entity shall not restate the combining operations' financial statements, but shall disclose the information on the same basis as previously used in the combining operations' financial statements. Where a resulting entity does not elect to present financial statements for the combining operations for periods prior to the amalgamation date, it shall meet the needs of users of the financial statements in one of the ways outlined in paragraph AG64.

**Disclosures**

- \*53. The resulting entity shall disclose information that enables users of its financial statements to evaluate the nature and financial effect of an amalgamation.**

**RDR 53.1 A Tier 2 entity is required to comply with the disclosures in paragraphs 54–57 that are not asterisked (\*) as RDR concessions.**

54. To meet the objective in paragraph 53, the resulting entity shall disclose the following information for each amalgamation that occurs during the reporting period:

- (a) The name and a description of each combining operation.
- (b) The amalgamation date.
- (c) The primary reasons for the amalgamation including, where applicable, the legal basis for the amalgamation.
- (d) The amounts recognised as of the amalgamation date for each major class of assets and liabilities transferred.
- (e) The adjustments made to the carrying amounts of assets and liabilities recorded by each combining operation as of the amalgamation date:
  - (i) To eliminate the effect of transactions between combining operations in accordance with paragraph 22; and
  - (ii) To conform to the resulting entity's accounting policies in accordance with paragraph 27.
- \*(f)** An analysis of net assets/equity, including any components that are presented separately, and any significant adjustments such as revaluation surpluses or deficits, recognised in accordance with paragraphs 37–38.
- (g) If a resulting entity elects to present financial statements for the combining operations for periods prior to the amalgamation date in accordance with paragraph 52, the resulting entity shall disclose the following information for each combining operation in the notes:
  - (i) A statement of financial position as at the end of the prior period(s);
  - (ii) A statement of comprehensive revenue and expense for the prior period(s);
  - (iii) A statement of changes in net assets/equity for the prior period(s);
  - (iv) A cash flow statement for the prior period(s); and
  - (v) Notes, comprising a summary of significant accounting policies and other explanatory notes.

The resulting entity shall not restate this information, but shall disclose the information on the same basis as previously used in the combining operations' financial statements. The resulting entity shall describe the significant differences between the resulting entity's accounting policies and the accounting policies previously applied by the combining operations. If the combining operations' prior period financial statements are not for the reporting period immediately prior to the amalgamation date the resulting entity shall also disclose the information specified in subparagraph (h) below.

- (h) If, at the time the financial statements of the resulting entity are authorised for issue, the last reporting date of any of the combining operations does not immediately precede the amalgamation date, the resulting entity shall disclose the following information:
  - (i) The amounts of revenue and expense, and the surplus or deficit of each combining operation from the last reporting date of the combining operations until the amalgamation date. The amounts of revenue shall be analysed in a manner appropriate to the entity's operations, in accordance with paragraph 108 of PBE IPSAS 1. The amounts of expense shall be analysed using a classification based on either the nature of expenses or their function within the entity, whichever provides information that is faithfully representative and more relevant, in accordance with paragraph 109 of PBE IPSAS 1.

- (ii) The amounts reported by each combining operation immediately prior to the amalgamation date for each major class of assets and liabilities.
- (iii) The amounts reported by each combining operation immediately prior to the amalgamation date in net assets/equity.

The resulting entity is not required to disclose this information where it has elected to present financial statements of the combining operations for the reporting period ending immediately prior to the amalgamation date as specified in subparagraph (g) above.

**\*55. The resulting entity shall disclose information that enables users of its financial statements to evaluate the financial effects of adjustments recognised in the current reporting period that relate to amalgamations that occurred in the period or previous reporting periods.**

56. To meet the objective in paragraph 55, the resulting entity shall disclose the following information:

- \*(a) If the initial accounting for an amalgamation is incomplete (see paragraph 40) for particular assets or liabilities, and the amounts recognised in the financial statements for the amalgamation thus have been determined only provisionally:
  - (i) The reasons why the initial accounting for the amalgamation is incomplete;
  - (ii) The assets or liabilities for which the initial accounting is incomplete; and
  - (iii) The nature and amount of any measurement period adjustments recognised during the reporting period in accordance with paragraph 43.
- (b) If amounts of tax due are forgiven as a result of the terms of the amalgamation (see paragraph 33):
  - (i) The amount of tax due that was forgiven; and
  - (ii) Where the resulting entity is the tax authority, details of the adjustment made to tax receivable.

RDR 56.1 For individually immaterial amalgamations occurring during the reporting period that are material collectively, the Tier 2 resulting entity shall disclose in aggregate the information required by paragraphs 54(d) and 56(b).

\*57. If the specific disclosures required by this and other PBE Standards do not meet the objectives set out in paragraphs 53 and 55, the resulting entity shall disclose whatever additional information is necessary to meet those objectives.

### Accounting for Acquisitions

58. **An acquirer shall account for each acquisition by applying the acquisition method of accounting.**

#### The Acquisition Method of Accounting

59. Applying the acquisition method of accounting requires:

- (a) Identifying the acquirer;
- (b) Determining the acquisition date;
- (c) Recognising and measuring the identifiable assets acquired, the liabilities assumed and any non-controlling interest in the acquired operation; and
- (d) Recognising and measuring goodwill, a gain or a loss from an acquisition.

#### Identifying the Acquirer

60. **For each acquisition, the party to the combination that gains control of one or more operations shall be identified as the acquirer.**

61. The party to the combination that gains control of one or more operations is identified when determining the classification of the PBE combination in accordance with paragraphs 7, 8 and AG10–AG18.

### Determining the Acquisition Date

62. **The acquirer shall identify the acquisition date, which is the date on which it obtains control of the acquired operation.**
63. The date on which the acquirer obtains control of the acquired operation is generally the date on which the acquirer legally transfers the consideration and/or acquires the assets and assumes the liabilities of the acquired operation—the closing date. However, the acquirer might obtain control on a date that is either earlier or later than the closing date. For example, the acquisition date precedes the closing date if a written agreement provides that the acquirer obtains control of the acquired operation on a date before the closing date. An acquirer shall consider all pertinent facts and circumstances in identifying the acquisition date.

### Recognising and Measuring the Identifiable Assets Acquired, the Liabilities Assumed and any Non-Controlling Interest in the Acquired Operation

#### *Recognition Principle*

64. **As of the acquisition date, the acquirer shall recognise, separately from any goodwill recognised, the identifiable assets acquired, the liabilities assumed and any non-controlling interest in the acquired operation. Recognition of identifiable assets acquired and liabilities assumed is subject to the conditions specified in paragraphs 65 and 66.**

#### Recognition Conditions

65. To qualify for recognition as part of applying the acquisition method, the identifiable assets acquired and liabilities assumed must meet the definitions of assets and liabilities in the *Public Benefit Entities' Conceptual Framework* at the acquisition date, and be capable of being measured in a way that achieves the qualitative characteristics and takes account of constraints on information in general purpose financial reporting. For example, costs the acquirer expects but is not obliged to incur in the future to effect its plan to exit an activity of an acquired operation or to terminate the employment of or relocate an acquired operation's employees are not liabilities at the acquisition date. Therefore, the acquirer does not recognise those costs as part of applying the acquisition method. Instead, the acquirer recognises those costs in its post-combination financial statements in accordance with other PBE Standards.
66. In addition, to qualify for recognition as part of applying the acquisition method, the identifiable assets acquired and liabilities assumed must be part of what the acquirer and the acquired operation (or its former owners) exchanged in the acquisition transaction rather than the result of separate transactions. The acquirer shall apply the guidance in paragraphs 109–111 to determine which assets acquired or liabilities assumed are part of the exchange for the acquired operation and which, if any, are the result of separate transactions to be accounted for in accordance with their nature and the applicable PBE Standards.
67. The acquirer's application of the recognition principle and conditions may result in recognising some assets and liabilities that the acquired operation had not previously recognised as assets and liabilities in its financial statements. For example, the acquirer recognises the acquired identifiable intangible assets, such as a patent or a customer relationship, that the acquired operation did not recognise as assets in its financial statements because it developed them internally and charged the related costs to expense.
68. Paragraphs AG72–AG84 provide guidance on recognising operating leases and intangible assets. Paragraphs 76–82 specify the types of identifiable assets and liabilities that include items for which this Standard provides limited exceptions to the recognition principle and conditions.

#### Classifying or Designating Identifiable Assets Acquired and Liabilities Assumed in an Acquisition

69. **At the acquisition date, the acquirer shall classify or designate the identifiable assets acquired and liabilities assumed as necessary to subsequently apply other PBE Standards. The acquirer shall make those classifications or designations on the basis of the terms of the binding arrangement (including contractual terms), economic conditions, its operating or accounting policies and other pertinent conditions as they exist at the acquisition date.**
70. In some situations, PBE Standards provide for different accounting depending on how an entity classifies or designates a particular asset or liability. Examples of classifications or designations that the acquirer



shall make on the basis of the pertinent conditions as they exist at the acquisition date include but are not limited to:

- (a) Classification of particular financial assets and liabilities as measured at fair value or at amortised cost, in accordance with PBE IPSAS 29;<sup>6</sup>
- (b) Designation of a derivative instrument as a hedging instrument in accordance with PBE IPSAS 29; and
- (c) Assessment of whether an embedded derivative should be separated from a host contract in accordance with PBE IPSAS 29 (which is a matter of ‘classification’ as this Standard uses that term).

71. This Standard provides two exceptions to the principle in paragraph 69:

- (a) Classification of a lease arrangement as either an operating lease or a finance lease in accordance with PBE IPSAS 13 *Leases*; and
- (b) Classification of a contract as an insurance contract in accordance with PBE IFRS 4 *Insurance Contracts*.

The acquirer shall classify those binding arrangements on the basis of the terms and other factors at the inception of the binding arrangement (or, if the terms of the binding arrangement have been modified in a manner that would change its classification, at the date of that modification, which might be the acquisition date).

#### *Measurement Principle*

72. **The acquirer shall measure the identifiable assets acquired and the liabilities assumed at their acquisition-date fair values.**

73. For each acquisition, the acquirer shall measure at the acquisition date components of non-controlling interests in the acquired operation that are present ownership interests and entitle their holders to a proportionate share of the entity’s net assets in the event of liquidation at either:

- (a) Fair value; or
- (b) The present ownership instruments’ proportionate share in the recognised amounts of the acquired operation’s identifiable net assets.

All other components of non-controlling interests shall be measured at their acquisition-date fair values, unless another measurement basis is required by PBE Standards.

74. Paragraphs 78–84.1 specify the types of identifiable assets and liabilities that include items for which this Standard provides limited exceptions to the measurement principle.

#### *Exceptions to the Recognition or Measurement Principles*

75. This Standard provides limited exceptions to its recognition and measurement principles. Paragraphs 76–84.1 specify both the particular items for which exceptions are provided and the nature of those exceptions. The acquirer shall account for those items by applying the requirements in paragraphs 76–84.1, which will result in some items being:

- (a) Recognised either by applying recognition conditions in addition to those in paragraphs 65–66 or by applying the requirements of other PBE Standards, with results that differ from applying the recognition principle and conditions.
- (b) Measured at an amount other than their acquisition-date fair values.

---

<sup>6</sup> If an entity applies this Standard and early adopts PBE IFRS 9 *Financial Instruments*, the references to PBE IPSAS 29 in this paragraph shall be read as references to PBE IFRS 9.

## Exception to the Recognition Principle

### Contingent Liabilities

76. PBE IPSAS 19 *Provisions, Contingent Liabilities and Contingent Assets*, defines a contingent liability as:
- (a) A possible obligation that arises from past events, and whose existence will be confirmed only by the occurrence or non-occurrence of one or more uncertain future events not wholly within the control of the entity; or
  - (b) A present obligation that arises from past events, but is not recognised because:
    - (i) It is not probable that an outflow of resources embodying economic benefits or service potential will be required to settle the obligation; or
    - (ii) The amount of the obligation cannot be measured with sufficient reliability.
77. The requirements in PBE IPSAS 19 do not apply in determining which contingent liabilities to recognise as of the acquisition date. Instead, the acquirer shall recognise as of the acquisition date a contingent liability assumed in an acquisition where consideration is transferred if it is a present obligation that arises from past events and its fair value can be measured reliably<sup>7</sup>. Therefore, contrary to PBE IPSAS 19, the acquirer recognises a contingent liability assumed in an acquisition where consideration is transferred at the acquisition date even if it is not probable that an outflow of resources embodying economic benefits or service potential will be required to settle the obligation. Paragraph 115 provides guidance on the subsequent accounting for contingent liabilities.

### Exceptions to both the Recognition and Measurement Principles

#### Income Taxes (where Included in the Terms of the Acquisition)

78. Acquisitions by a public sector entity may result in a tax authority forgiving amounts of tax due as part of the terms of the acquisition. The acquirer shall not recognise any taxation items that are forgiven as a result of the terms of the acquisition (paragraphs AG85 and AG87 provide related application guidance).
79. [Not used]
- 79.1 The acquirer shall recognise and measure a deferred tax asset or liability arising from the assets acquired and liabilities assumed in a PBE combination in accordance with PBE IAS 12.
- 79.2 The acquirer shall account for the potential tax effects of temporary differences and carryforwards of the acquired operation that exist at the acquisition date or arise as a result of the acquisition in accordance with PBE IAS 12.

#### Employee Benefits

80. The acquirer shall recognise and measure a liability (or asset, if any) related to the acquired operation's employee benefit arrangements in accordance with PBE IPSAS 39.

#### Indemnification Assets

81. The seller in an acquisition may contractually indemnify the acquirer for the outcome of a contingency or uncertainty related to all or part of a specific asset or liability. For example, the seller may indemnify the acquirer against losses above a specified amount on a liability arising from a particular contingency; in other words, the seller will guarantee that the acquirer's liability will not exceed a specified amount. As a result, the acquirer obtains an indemnification asset. The acquirer shall recognise an indemnification asset at the same time that it recognises the indemnified item measured on the same basis as the indemnified item, subject to the need for a valuation allowance for uncollectible amounts. Therefore, if the indemnification relates to an asset or a liability that is recognised at the acquisition date and measured at its acquisition-date fair value, the acquirer shall recognise the indemnification asset at the acquisition date measured at its acquisition-date fair value. For an indemnification asset measured at fair value, the effects of uncertainty about future cash flows because of collectibility considerations are included in the fair value

---

<sup>7</sup> Information that is reliable is free from material error and bias, and can be depended on by users to faithfully represent that which it purports to represent or could reasonably be expected to represent. Paragraph BC10 of PBE IPSAS 1 discusses the transitional approach to the explanation of reliability.

measure and a separate valuation allowance is not necessary (paragraph AG88 provides related application guidance).

82. In some circumstances, the indemnification may relate to an asset or a liability that is an exception to the recognition or measurement principles. For example, an indemnification may relate to a contingent liability that is not recognised at the acquisition date because its fair value is not reliably measurable at that date. Alternatively, an indemnification may relate to an asset or a liability, for example, one that results from an employee benefit, that is measured on a basis other than acquisition-date fair value. In those circumstances, the indemnification asset shall be recognised and measured using assumptions consistent with those used to measure the indemnified item, subject to management's assessment of the collectibility of the indemnification asset and any contractual limitations on the indemnified amount. Paragraph 116 provides guidance on the subsequent accounting for an indemnification asset.

#### Exceptions to the Measurement Principle

##### Reacquired Rights

83. The acquirer shall measure the value of a reacquired right recognised as an intangible asset on the basis of the remaining term of the related binding arrangement regardless of whether market participants would consider potential renewals of binding arrangements when measuring its fair value. Paragraphs AG79–AG80 provide related application guidance.

##### Share-Based Payment Transactions

84. The acquirer shall measure a liability or an equity instrument related to share-based payment transactions of the acquired operation or the replacement of an acquired operation's share-based payment transactions with share-based payment transactions of the acquirer in accordance with the relevant international or national accounting standard dealing with share-based payments.

##### Assets Held for Sale

- 84.1 The acquirer shall measure an acquired non-current asset (or disposal group) that is classified as held for sale at the acquisition date in accordance with PBE IFRS 5 *Non-current Assets Held for Sale and Discontinued Operations* at fair value less costs to sell in accordance with paragraphs 15–18 of that Standard.

#### Recognising and Measuring Goodwill or a Gain from a Bargain Purchase

85. **The acquirer shall recognise goodwill as of the acquisition date measured as the excess of (a) over (b) below, subject to the requirements of paragraph 86:**
- (a) **The aggregate of:**
    - (i) **The consideration transferred measured in accordance with this Standard, which generally requires acquisition-date fair value (see paragraph 95);**
    - (ii) **The amount of any non-controlling interest in the acquired operation measured in accordance with this Standard; and**
    - (iii) **In an acquisition achieved in stages (see paragraphs 99–100), the acquisition-date fair value of the acquirer's previously held equity interest in the acquired operation.**
  - (b) **The net of the acquisition-date amounts of the identifiable assets acquired and the liabilities assumed measured in accordance with this Standard.**
86. **The acquirer shall recognise goodwill only to the extent that:**
- (a) **The acquisition will result in the generation of net cash inflows; and**
  - (b) **The goodwill arises from the acquisition of a cash-generating operation.**

**An acquirer shall recognise any further excess of (a) over (b) in paragraph 85 above as a loss in surplus or deficit. Paragraph AG93 provides related application guidance.**

87. In an acquisition in which the acquirer and the acquired operation (or its former owners) exchange only equity interests, the acquisition-date fair value of the acquired operation's equity interests may be more

reliably measurable than the acquisition-date fair value of the acquirer's equity interests. If so, the acquirer shall determine the amount of goodwill by using the acquisition-date fair value of the acquired operation's equity interests instead of the acquisition-date fair value of the equity interests transferred. To determine the amount of goodwill in an acquisition in which no consideration is transferred in those situations covered in paragraphs 101 and 102, the acquirer shall use the acquisition-date fair value of the acquirer's interest in the acquired operation in place of the acquisition-date fair value of the consideration transferred (paragraph 85(a)(i)). Paragraphs AG94–AG97 provide related application guidance.

#### *Bargain Purchases*

88. Occasionally in a PBE combination classified as an acquisition, an acquirer will make a bargain purchase, which is an acquisition in which the amount in paragraph 85(b) exceeds the aggregate of the amounts specified in paragraph 85(a). If that excess remains after applying the requirements in paragraph 90, the acquirer shall recognise the resulting gain in surplus or deficit on the acquisition date. The gain shall be attributed to the acquirer.
89. A bargain purchase might happen, for example, in an acquisition that is a forced sale in which the seller is acting under economic compulsion. However, the recognition or measurement exceptions for particular items discussed in paragraphs 76–84.1 may also result in recognising a gain (or change the amount of a recognised gain) on a bargain purchase.
90. Before recognising a gain on a bargain purchase, the acquirer shall reassess whether it has correctly identified all of the assets acquired and all of the liabilities assumed and shall recognise any additional assets or liabilities that are identified in that review. The acquirer shall then review the procedures used to measure the amounts this Standard requires to be recognised at the acquisition date for all of the following:
- (a) The identifiable assets acquired and liabilities assumed;
  - (b) The non-controlling interest in the acquired operation, if any;
  - (c) For an acquisition achieved in stages, the acquirer's previously held equity interest in the acquired operation; and
  - (d) The consideration transferred.
- The objective of the review is to ensure that the measurements appropriately reflect consideration of all available information as of the acquisition date.
91. In the public and not-for-profit sectors, an entity sometimes obtains control of an operation in a non-exchange transaction in which it transfers consideration that is not approximately equal to the fair value of the acquired operation. Such circumstances include, but are not limited to:
- (a) Compensated seizures of operations or entities; and
  - (b) The transfer of an operation to the acquirer by a donor for nominal consideration.
92. Where the economic substance of the PBE combination is that of an acquisition, such non-exchange acquisitions are treated as bargain purchases and accounted for in accordance with paragraphs 88–90.

#### *A Non-Exchange Acquisition without the Transfer of Consideration*

93. In the public and not-for-profit sectors, an entity sometimes obtains control of an operation in a non-exchange transaction in which it transfers no consideration. Such circumstances include, but are not limited to:
- (a) Uncompensated seizures of operations or entities (also known as forced nationalisations).
  - (b) The transfer of an operation to the entity by a donor for no consideration. Such transfers may take the form of a bequest.
- And
- (c) The transfer of an operation to the entity where the operation has net liabilities. The entity may accept the transfer of net liabilities to prevent the cessation of the operation. Such transactions are sometimes known as "bailouts".

94. Where the economic substance of the PBE combination is that of an acquisition, the acquirer that obtains control of an acquired operation in a non-exchange transaction in which it transfers no consideration does not recognise goodwill. The acquirer recognises a gain or a loss in surplus or deficit.

#### *Consideration Transferred*

95. The consideration transferred in an acquisition shall be measured at fair value, which shall be calculated as the sum of the acquisition-date fair values of the assets transferred by the acquirer, the liabilities incurred by the acquirer to former owners of the acquired operation and the equity interests issued by the acquirer. (However, any portion of the acquirer's share-based payment awards exchanged for awards held by the acquired operation's employees that is included in consideration transferred in the acquisition shall be measured in accordance with paragraph 84 rather than at fair value.) Examples of potential forms of consideration include cash, other assets, an operation or a controlled entity of the acquirer, contingent consideration, ordinary or preference equity instruments, options, warrants and member interests of mutual entities.
96. The consideration transferred may include assets or liabilities of the acquirer that have carrying amounts that differ from their fair values at the acquisition date (for example, non-monetary assets or an operation of the acquirer). If so, the acquirer shall remeasure the transferred assets or liabilities to their fair values as of the acquisition date and recognise the resulting gains or losses, if any, in surplus or deficit. However, sometimes the transferred assets or liabilities remain within the combined entity after the acquisition (for example, because the assets or liabilities were transferred to the acquired operation rather than to its former owners), and the acquirer therefore retains control of them. In that situation, the acquirer shall measure those assets and liabilities at their carrying amounts immediately before the acquisition date and shall not recognise a gain or loss in surplus or deficit on assets or liabilities it controls both before and after the acquisition.

#### *Contingent Consideration*

97. The consideration the acquirer transfers in exchange for the acquired operation includes any asset or liability resulting from a contingent consideration arrangement (see paragraph 95). The acquirer shall recognise the acquisition-date fair value of contingent consideration as part of the consideration transferred in exchange for the acquired operation.
98. The acquirer shall classify an obligation to pay contingent consideration that meets the definition of a financial instrument as a financial liability or as a component of net assets/equity on the basis of the definitions of an equity instrument and a financial liability in paragraph 9 of PBE IPSAS 28. The acquirer shall classify as an asset a right to the return of previously transferred consideration if specified conditions are met. Paragraph 117 provides guidance on the subsequent accounting for contingent consideration.

#### **An Acquisition Achieved in Stages**

99. An acquirer sometimes obtains control of an acquired operation in which it held an equity interest immediately before the acquisition date. For example, on 31 December 20X1, Entity A holds a 35 percent non-controlling equity interest in Entity B. On that date, Entity A purchases an additional 40 percent interest in Entity B, which gives it control of Entity B. This Standard refers to such a transaction as an acquisition achieved in stages, sometimes also referred to as a step acquisition.
100. In an acquisition achieved in stages, the acquirer shall remeasure its previously held equity interest in the acquired operation at its acquisition-date fair value and recognise the resulting gain or loss, if any, in surplus or deficit or in other comprehensive revenue and expense, as appropriate. In prior reporting periods, the acquirer may have recognised changes in the value of its equity interest in the acquired operation in other comprehensive revenue and expense (for example, because the investment was classified as available for sale). If so, the amount that was recognised in other comprehensive revenue and expense shall be recognised on the same basis as would be required if the acquirer had disposed directly of the previously held equity interest.
- 100A. When a party to a joint arrangement (as defined in PBE IPSAS 37 *Joint Arrangements*) obtains control of an operation that is a joint operation (as defined in PBE IPSAS 37), and had rights to the assets and obligations for the liabilities relating to that joint operation immediately before the acquisition date, the transaction is an acquisition achieved in stages. The acquirer shall therefore apply the requirements for an acquisition achieved in stages, including remeasuring its previously held interest in the joint operation in

the manner described in paragraph 100. In doing so, the acquirer shall remeasure its entire previously held interest in the joint operation.<sup>8</sup>

### **Additional Guidance for Applying the Acquisition Method where an Acquisition is Achieved Through Changes in Voting Rights, by Contract Alone, and Similar Circumstances in which no Consideration is Transferred**

#### *An Acquisition Achieved Through Changes in Voting Rights, by Contract Alone, and Similar Circumstances not Involving the Transfer of Consideration*

101. An acquirer sometimes obtains control of an acquired operation without transferring consideration. The acquisition method of accounting for an acquisition applies to those PBE combinations. Such circumstances include:
- (a) The acquired operation repurchases a sufficient number of its own shares for an existing investor (the acquirer) to obtain control.
  - (b) Minority veto rights lapse that previously kept the acquirer from controlling an acquired operation in which the acquirer held the majority voting rights.
  - (c) The acquirer and acquired operation agree to combine their operations by contract alone. The acquirer transfers no consideration in exchange for control of an acquired operation and holds no equity interests in the acquired operation, either on the acquisition date or previously.
102. In an acquisition achieved by contract alone, the acquirer shall attribute to the owners of the acquired operation the amount of the acquired operation's net assets recognised in accordance with this Standard. In other words, the equity interests in the acquired operation held by parties other than the acquirer are a non-controlling interest in the acquirer's post-combination financial statements even if the result is that all of the equity interests in the acquired operation are attributed to the non-controlling interest.

#### **Measurement Period**

103. **If the initial accounting for an acquisition is incomplete by the end of the reporting period in which the acquisition occurs, the acquirer shall report in its financial statements provisional amounts for the items for which the accounting is incomplete. During the measurement period, the acquirer shall retrospectively adjust the provisional amounts recognised at the acquisition date to reflect new information obtained about facts and circumstances that existed as of the acquisition date and, if known, would have affected the measurement of the amounts recognised as of that date. During the measurement period, the acquirer shall also recognise additional assets or liabilities if new information is obtained about facts and circumstances that existed as of the acquisition date and, if known, would have resulted in the recognition of those assets and liabilities as of that date. The measurement period ends as soon as the acquirer receives the information it was seeking about facts and circumstances that existed as of the acquisition date or learns that more information is not obtainable. However, the measurement period shall not exceed one year from the acquisition date.**
104. The measurement period is the period after the acquisition date during which the acquirer may adjust the provisional amounts recognised for an acquisition. The measurement period provides the acquirer with a reasonable time to obtain the information necessary to identify and measure the following as of the acquisition date in accordance with the requirements of this Standard:
- (a) The identifiable assets acquired, liabilities assumed and any non-controlling interest in the acquired operation;
  - (b) The consideration transferred for the acquired operation (or the other amount used in measuring goodwill);
  - (c) In an acquisition achieved in stages, the equity interest in the acquired operation previously held by the acquirer; and
  - (d) The resulting goodwill, loss, or gain on a bargain purchase.

<sup>8</sup> Paragraph 100A is aligned with proposed amendments to PBE IFRS 3 *Business Combinations* (see NZASB ED 2018-3 *2018 Omnibus Amendments to PBE Standards*) and equivalent proposed amendments to IPSAS 40 (see IPSASB ED 65 *Improvements to IPSAS, 2018*).

105. The acquirer shall consider all pertinent factors in determining whether information obtained after the acquisition date should result in an adjustment to the provisional amounts recognised or whether that information results from events that occurred after the acquisition date. Pertinent factors include the date when additional information is obtained and whether the acquirer can identify a reason for a change to provisional amounts. Information that is obtained shortly after the acquisition date is more likely to reflect circumstances that existed at the acquisition date than is information obtained several months later. For example, unless an intervening event that changed its fair value can be identified, the sale of an asset to a third party shortly after the acquisition date for an amount that differs significantly from its provisional fair value measured at that date is likely to indicate an error in the provisional amount.
106. The acquirer recognises an increase (decrease) in the provisional amount recognised for an identifiable asset (liability) by means of a decrease (increase) in goodwill, subject to the requirements for recognition of goodwill in paragraph 86. However, new information obtained during the measurement period may sometimes result in an adjustment to the provisional amount of more than one asset or liability. For example, the acquirer might have assumed a liability to pay damages related to an accident in one of the acquired operation's facilities, part or all of which is covered by the acquired operation's liability insurance policy. If the acquirer obtains new information during the measurement period about the acquisition-date fair value of that liability, the adjustment to goodwill resulting from a change to the provisional amount recognised for the liability would be offset (in whole or in part) by a corresponding adjustment to goodwill resulting from a change to the provisional amount recognised for the claim receivable from the insurer.
107. During the measurement period, the acquirer shall recognise adjustments to the provisional amounts as if the accounting for the acquisition had been completed at the acquisition date. Thus, the acquirer shall revise comparative information for prior periods presented in financial statements as needed, including making any change in depreciation, amortisation or other income effects recognised in completing the initial accounting.
108. After the measurement period ends, the acquirer shall revise the accounting for an acquisition only to correct an error in accordance with PBE IPSAS 3.

#### **Determining what is Part of the Acquisition Transaction**

109. **The acquirer and the acquired operation may have a pre-existing relationship or other arrangement before negotiations for the acquisition began, or they may enter into an arrangement during the negotiations that is separate from the acquisition. In either situation, the acquirer shall identify any amounts that are not part of what the acquirer and the acquired operation (or its former owners) exchanged in the acquisition, i.e., amounts that are not part of the exchange for the acquired operation. The acquirer shall recognise as part of applying the acquisition method only the consideration transferred for the acquired operation and the assets acquired and liabilities assumed in the exchange for the acquired operation. Separate transactions shall be accounted for in accordance with the relevant PBE Standards.**
110. A transaction entered into by or on behalf of the acquirer or primarily for the benefit of the acquirer or the combined entity, rather than primarily for the benefit of the acquired operation (or its former owners) before the acquisition, is likely to be a separate transaction. The following are examples of separate transactions that are not to be included in applying the acquisition method:
- (a) A transaction that in effect settles pre-existing relationships between the acquirer and acquired operation;
  - (b) A transaction that remunerates employees or former owners of the acquired operation for future services; and
  - (c) A transaction that reimburses the acquired operation or its former owners for paying the acquirer's acquisition-related costs.

Paragraphs AG99–AG106 provide related application guidance.

#### *Acquisition-Related Costs*

111. Acquisition-related costs are costs the acquirer incurs to effect an acquisition. Those costs include finder's fees; advisory, legal, accounting, valuation and other professional or consulting fees; general administrative costs, including the costs of maintaining an internal acquisitions department; and costs of registering and

issuing debt and equity securities. The acquirer shall account for acquisition-related costs as expenses in the periods in which the costs are incurred and the services are received, with one exception. The costs to issue debt or equity securities shall be recognised in accordance with PBE IPSAS 28 and PBE IPSAS 29.<sup>9</sup>

### Subsequent Measurement and Accounting

112. **In general, an acquirer shall subsequently measure and account for assets acquired, liabilities assumed or incurred and equity instruments issued in an acquisition in accordance with other applicable PBE Standards for those items, depending on their nature. However, this Standard provides guidance on subsequently measuring and accounting for the following assets acquired, liabilities assumed or incurred and equity instruments issued in an acquisition:**

- (a) **Reacquired rights;**
- (b) **Contingent liabilities recognised as of the acquisition date;**
- (c) **Indemnification assets;**
- (d) **Contingent consideration; and**
- (e) **Income taxes (where not included in the terms of the acquisition).**

**Paragraphs AG107–AG108 provide related application guidance.**

#### *Reacquired Rights*

113. A reacquired right recognised as an intangible asset shall be amortised over the remaining period of the binding arrangement in which the right was granted, where the right was granted for a finite period. Where the right was granted for an indefinite period, the resulting entity shall test the right for impairment at least annually, and whenever there is an indication that the right may be impaired. An acquirer that subsequently sells a reacquired right to a third party shall include the carrying amount of the intangible asset in determining the gain or loss on the sale.

#### *Transfers, Concessionary Loans and Similar Benefits Received by an Acquirer or Acquired Operation on the Basis of Criteria that may Change as a Result of an Acquisition*

114. A transfer, concessionary loan or similar benefit, previously received by an acquirer or an acquired operation on the basis of criteria that change as a result of an acquisition, shall be reassessed prospectively in accordance with other PBE Standards (paragraphs AG109–AG111 provide related application guidance).

#### *Contingent Liabilities*

115. After initial recognition and until the liability is settled, cancelled or expires, the acquirer shall measure a contingent liability recognised in an acquisition at the higher of:

- (a) The amount that would be recognised in accordance with PBE IPSAS 19; and
- (b) The amount initially recognised less, if appropriate, cumulative amortisation recognised in accordance with PBE IPSAS 9 *Revenue from Exchange Transactions*.

This requirement does not apply to contracts accounted for in accordance with PBE IPSAS 29.<sup>10</sup>

#### *Indemnification Assets*

116. At the end of each subsequent reporting period, the acquirer shall measure an indemnification asset that was recognised at the acquisition date on the same basis as the indemnified liability or asset, subject to any contractual limitations on its amount and, for an indemnification asset that is not subsequently measured at its fair value, management's assessment of the collectibility of the indemnification asset. The acquirer shall derecognise the indemnification asset only when it collects the asset, sells it or otherwise loses the right to it.

<sup>9</sup> If an entity applies this Standard and early adopts PBE IFRS 9 *Financial Instruments*, the references to PBE IPSAS 29 in this paragraph shall be read as references to PBE IFRS 9.

<sup>10</sup> If an entity applies this Standard and early adopts PBE IFRS 9 *Financial Instruments*, the references to PBE IPSAS 29 in this paragraph shall be read as references to PBE IFRS 9.



*Contingent Consideration*

117. Some changes in the fair value of contingent consideration that the acquirer recognises after the acquisition date may be the result of additional information that the acquirer obtained after that date about facts and circumstances that existed at the acquisition date. Such changes are measurement period adjustments in accordance with paragraphs 103–107. However, changes resulting from events after the acquisition date, such as meeting an earnings target, reaching a specified share price or reaching a milestone on a research and development project, are not measurement period adjustments. The acquirer shall account for changes in the fair value of contingent consideration that are not measurement period adjustments as follows:
- (a) Contingent consideration classified as a component of net assets/equity shall not be remeasured and its subsequent settlement shall be accounted for within net assets/equity.
  - (b) Other contingent consideration that:
    - (i) Is within the scope of PBE IPSAS 29<sup>11</sup> shall be measured at fair value at each reporting date and changes in fair value shall be recognised in surplus or deficit in accordance with PBE IPSAS 29.
    - (ii) Is not within the scope of PBE IPSAS 29 shall be measured at fair value at each reporting date and changes in fair value shall be recognised in surplus or deficit.

*Income Taxes (where not Included in the Terms of the Acquisition)*

118. Acquisitions involving public sector entities may result in a tax authority forgiving amounts of tax subsequent to the acquisition. The acquirer shall account for the tax forgiven prospectively in accordance with PBE IAS 12.

**Disclosures**

- \*119. **The acquirer shall disclose information that enables users of its financial statements to evaluate the nature and financial effect of an acquisition that occurs either:**
- (a) **During the current reporting period; or**
  - (b) **After the end of the reporting period but before the financial statements are authorised for issue.**
- RDR 119.1 A Tier 2 entity is required to comply with the disclosures in paragraphs 120–124 that are not asterisked (\*) as RDR concessions.
120. To meet the objective in paragraph 119, the acquirer shall disclose the following information for each acquisition that occurs during the reporting period:
- (a) The name and a description of the acquired operation.
  - (b) The acquisition date.
  - (c) The percentage of voting equity interests or equivalent acquired.
  - \*(d) The primary reasons for the acquisition and a description of how the acquirer obtained control of the acquired operation including, where applicable, the legal basis for the acquisition.
  - \*(e) A qualitative description of the factors that make up the goodwill recognised, such as expected synergies from combining the operations of the acquired operation and the acquirer, intangible assets that do not qualify for separate recognition or other factors.
  - (f) The acquisition-date fair value of the total consideration transferred and the acquisition-date fair value of each major class of consideration, such as:
    - (i) Cash;
    - (ii) Other tangible or intangible assets, including an operation or controlled entity of the acquirer;
    - (iii) Liabilities incurred, for example, a liability for contingent consideration; and

<sup>11</sup> If an entity applies this Standard and early adopts PBE IFRS 9 *Financial Instruments*, the references to PBE IPSAS 29 in this paragraph shall be read as references to PBE IFRS 9.

- (iv) Equity interests of the acquirer, including the number of instruments or interests issued or issuable and the method of measuring the fair value of those instruments or interests.
- (g) For contingent consideration arrangements and indemnification assets:
  - (i) The amount recognised as of the acquisition date;
  - (ii) A description of the arrangement and the basis for determining the amount of the payment; and
  - (iii) An estimate of the range of outcomes (undiscounted) or, if a range cannot be estimated, that fact and the reasons why a range cannot be estimated. If the maximum amount of the payment is unlimited, the acquirer shall disclose that fact.
- \* (h) For acquired receivables:
  - (i) The fair value of the receivables;
  - (ii) The gross amounts receivable in accordance with a binding arrangement; and
  - (iii) The best estimate at the acquisition date of the cash flows in accordance with a binding arrangement not expected to be collected.

The disclosures shall be provided by major class of receivable, such as loans, direct finance leases and any other class of receivables.
- (i) The amounts recognised as of the acquisition date for each major class of assets acquired and liabilities assumed.
- (j) For each contingent liability recognised in accordance with paragraph 77, the information required in paragraph 98 of PBE IPSAS 19. If a contingent liability is not recognised because its fair value cannot be measured reliably, the acquirer shall disclose:
  - \* (i) The information required by paragraph 100 of PBE IPSAS 19; and
  - \* (ii) The reasons why the liability cannot be measured reliably.
- \* (k) The total amount of goodwill that is expected to be deductible for tax purposes.
- \* (l) For transactions that are recognised separately from the acquisition of assets and assumption of liabilities in the acquisition in accordance with paragraph 109:
  - (i) A description of each transaction;
  - (ii) How the acquirer accounted for each transaction;
  - (iii) The amounts recognised for each transaction and the line item in the financial statements in which each amount is recognised; and
  - (iv) If the transaction is the effective settlement of a pre-existing relationship, the method used to determine the settlement amount.
- \* (m) The disclosure of separately recognised transactions required by (l) shall include the amount of acquisition-related costs and, separately, the amount of those costs recognised as an expense and the line item or items in the statement of comprehensive revenue and expense in which those expenses are recognised. The amount of any issue costs not recognised as an expense and how they were recognised shall also be disclosed.
- (n) In an acquisition in which a loss is recognised in surplus or deficit (see paragraph 86):
  - (i) The amount of the loss recognised in accordance with paragraph 86 and the line item in the statement of comprehensive revenue and expense in which the loss is recognised; and
  - \* (ii) A description of the reasons why the transaction resulted in a loss.
- (o) In a bargain purchase (see paragraphs 88–90):
  - (i) The amount of any gain recognised in accordance with paragraph 88 and the line item in the statement of comprehensive revenue and expense in which the gain is recognised; and
  - \* (ii) A description of the reasons why the transaction resulted in a gain.

- (p) For each acquisition in which the acquirer holds less than 100 percent of the equity interests or equivalent in the acquired operation at the acquisition date:
  - (i) The amount of the non-controlling interest in the acquired operation recognised at the acquisition date and the measurement basis for that amount; and
  - (ii) For each non-controlling interest in an acquired operation measured at fair value, the valuation technique(s) and significant inputs used to measure that value.
- (q) In an acquisition achieved in stages:
  - (i) The acquisition-date fair value of the equity interest in the acquired operation held by the acquirer immediately before the acquisition date; and
  - (ii) The amount of any gain or loss recognised as a result of remeasuring to fair value the equity interest in the acquired operation held by the acquirer before the acquisition (see paragraph 100) and the line item in the statement of comprehensive revenue and expense in which that gain or loss is recognised.
- \* (r) The following information:
  - (i) The amounts of revenue and expense, and the surplus or deficit of the acquired operation since the acquisition date included in the consolidated statement of comprehensive revenue and expense for the reporting period; and
  - (ii) The revenue and expense, and the surplus or deficit of the combined entity for the current reporting period as though the acquisition date for all acquisitions that occurred during the year had been as of the beginning of the annual reporting period.

If disclosure of any of the information required by this subparagraph is impracticable, the acquirer shall disclose that fact and explain why the disclosure is impracticable. This Standard uses the term 'impracticable' with the same meaning as in PBE IPSAS 3.

RDR 120.1 A Tier 2 entity is not required to make the disclosures required by paragraph 120(j)(i) and (ii) if a contingent liability is not recognised in accordance with paragraph 77 because its fair value cannot be measured reliably.

\*121. For individually immaterial acquisitions occurring during the reporting period that are material collectively, the acquirer shall disclose in aggregate the information required by paragraph 120(e)–(r).

RDR 121.1 For individually immaterial acquisitions occurring during the reporting period that are material collectively, a Tier 2 acquirer shall disclose in aggregate the information required by paragraphs 120(f), 120(g), 120(i), 120(n)(i), 120(o)(i), 120(p)(i), 120(q) and the first sentence of paragraph 120(j).

\*122. If the acquisition date of an acquisition is after the end of the reporting period but before the financial statements are authorised for issue, the acquirer shall disclose the information required by paragraph 120 unless the initial accounting for the acquisition is incomplete at the time the financial statements are authorised for issue. In that situation, the acquirer shall describe which disclosures could not be made and the reasons why they cannot be made.

\*123. **The acquirer shall disclose information that enables users of its financial statements to evaluate the financial effects of adjustments recognised in the current reporting period that relate to acquisitions that occurred in the period or previous reporting periods.**

124. To meet the objective in paragraph 123, the acquirer shall disclose the following information for each material acquisition or in the aggregate for individually immaterial acquisitions that are material collectively:

- \* (a) If the initial accounting for an acquisition is incomplete (see paragraph 103) for particular assets, liabilities, non-controlling interests or items of consideration and the amounts recognised in the financial statements for the acquisition thus have been determined only provisionally:
  - (i) The reasons why the initial accounting for the acquisition is incomplete;
  - (ii) The assets, liabilities, equity interests (or equivalent) or items of consideration for which the initial accounting is incomplete; and

- (iii) The nature and amount of any measurement period adjustments recognised during the reporting period in accordance with paragraph 107.
- \* (b) For each reporting period after the acquisition date until the entity collects, sells or otherwise loses the right to a contingent consideration asset, or until the entity settles a contingent consideration liability or the liability is cancelled or expires:
  - (i) Any changes in the recognised amounts, including any differences arising upon settlement;
  - (ii) Any changes in the range of outcomes (undiscounted) and the reasons for those changes; and
  - (iii) The valuation techniques and key model inputs used to measure contingent consideration.
- \* (c) For contingent liabilities recognised in an acquisition, the acquirer shall disclose the information required by paragraphs 97 and 98 of PBE IPSAS 19 for each class of provision.<sup>12</sup>
- (d) A reconciliation of the carrying amount of goodwill at the beginning and end of the reporting period showing separately:
  - (i) The gross amount and accumulated impairment losses at the beginning of the reporting period.
  - (ii) Additional goodwill recognised during the reporting period, except goodwill included in a disposal group that, on acquisition, meets the criteria to be classified as held for sale in accordance with PBE IFRS 5.
  - (iii) Adjustments resulting from the subsequent recognition of amounts during the reporting period in accordance with PBE IAS 12.
  - (iv) Goodwill included in a disposal group classified as held for sale in accordance with PBE IFRS 5 and goodwill derecognised during the reporting period without having previously been included in a disposal group classified as held for sale.
  - (v) Impairment losses recognised during the reporting period in accordance with PBE IPSAS 26 *Impairment of Cash-Generating Assets*. (PBE IPSAS 26 requires disclosure of information about the recoverable amount and impairment of goodwill in addition to this requirement.)
  - (vi) Net exchange rate differences arising during the reporting period in accordance with PBE IPSAS 4 *The Effects of Changes in Foreign Exchange Rates*.
  - (vii) Any other changes in the carrying amount during the reporting period.
  - (viii) The gross amount and accumulated impairment losses at the end of the reporting period.
- \* (e) The amount and an explanation of any gain or loss recognised in the current reporting period that both:
  - (i) Relates to the identifiable assets acquired or liabilities assumed in an acquisition that was effected in the current or previous reporting period; and
  - (ii) Is of such a size, nature or incidence that disclosure is relevant to understanding the combined entity's financial statements.

And

- (f) If amounts of tax due are forgiven as a result of the terms of the acquisition (see paragraphs 78):
  - (i) The amount of tax due that was forgiven; and
  - (ii) Where the acquirer is the tax authority, details of the adjustment made to tax receivable.

RDR 124.1 A Tier 2 entity is not required to disclose the reconciliation specified in paragraph 124(d) for prior periods.

\*125. If the specific disclosures required by this and other PBE Standards do not meet the objectives set out in paragraphs 119 and 123, the acquirer shall disclose whatever additional information is necessary to meet those objectives.

---

<sup>12</sup> See PBE IPSAS 19 paragraph 97 for disclosure concessions for Tier 2 entities.

## Effective Date and Transition

### Effective Date

126. [Not used].

126.1 **A public benefit entity shall apply this Standard for annual financial statements covering periods beginning on or after [date]. Earlier application is permitted. If a public benefit entity applies this Standard for a period beginning before [date], it shall disclose that fact.**

### Transition

127–134. [Not used]

134.1 Except as provided in paragraph 134.3, this Standard shall be applied prospectively to PBE combinations for which the amalgamation date or acquisition date is on or after [date].

134.2 Except as provided in paragraph 134.3, an entity shall not restate PBE combinations that occurred from any date before the effective date in paragraph 126.1.

### Limited Retrospective Application

134.3 An entity is permitted to apply the requirements of this Standard to PBE combinations that occurred before the effective date in paragraph 126.1, provided that on first-time application of this Standard it is also a first-time adopter of PBE Standards and has adopted PBE FRS 47 *First-time Adoption of PBE Standards by Entities Other Than Those Previously Applying NZ IFRS*.

## Withdrawal and Replacement of PBE IFRS 3 (2014)

134.4 This Standard supersedes PBE IFRS 3 *Business Combinations* (2014). PBE IFRS 3 remains applicable until PBE IPSAS 40 is applied or becomes effective, whichever is earlier.

## Application Guidance

*This Appendix is an integral part of PBE IPSAS 40*

### Definitions (see paragraph 5)

AG1. [Not used]

### Identifying a PBE Combination (see paragraph 6)

AG2. Paragraph 5 defines a PBE combination as “the bringing together of separate operations into one public benefit entity.” The reference to one public benefit entity may be to a single entity or to an economic entity. Some public sector or not-for-profit sector reorganisations may involve more than one entity combination. The circumstances in which a PBE combination might occur include:

- (a) By mutual agreement; and
- (b) By compulsion (for example by legislation).

AG3. Paragraph 5 defines an operation as “an integrated set of activities and related assets and/or liabilities that is capable of being conducted and managed for the purpose of achieving an entity’s objectives, by providing goods and/or services.”

AG4. An operation consists of inputs and processes applied to those inputs that have the ability to create outputs. Although operations usually have outputs, outputs are not required for an integrated set of activities and related assets and/or liabilities to qualify as an operation. For the purposes of this standard, the three elements of an operation are defined as follows:

- (a) **Input:** Any economic resource that creates, or has the ability to create, outputs when one or more processes are applied to it. Examples include non-current assets (including intangible assets or rights to use non-current assets), intellectual property, the ability to obtain access to necessary materials or rights and employees.
- (b) **Process:** Any system, standard, protocol, convention or rule that when applied to an input or inputs, creates or has the ability to create outputs. Examples include strategic management processes, operational processes and resource management processes. These processes typically are documented, but an organised workforce having the necessary skills and experience following rules and conventions may provide the necessary processes that are capable of being applied to inputs to create outputs. (Accounting, billing, payroll and other administrative systems typically are not processes used to create outputs.)
- (c) **Output:** The result of inputs and processes applied to those inputs that provide, or have the ability to provide a return in the form of dividends, lower costs or other economic benefits directly to investors or other owners, members or participants. Outputs may also be in the form of goods and services for community or social benefit.

AG5. To be capable of being conducted and managed for the purposes defined, an integrated set of activities and assets and/or liabilities requires two essential elements—inputs and processes applied to those inputs, which together are or will be used to create outputs. However, an operation need not include all of the inputs or processes that the transferor used in operating that operation if the entity that receives the operation or operations is capable of continuing to produce outputs, for example, by integrating the operation with its own inputs and processes.

AG6. The nature of the elements of an operation varies by sector and by the structure of an entity’s operations (activities), including the entity’s stage of development. Established operations often have many different types of inputs, processes and outputs, whereas new operations often have few inputs and processes and sometimes only a single output (product). Nearly all operations also have liabilities, but an operation need not have liabilities.

- AG7. An integrated set of activities and assets and/or liabilities in the development stage might not have outputs. In these cases, the entity that receives the operation should consider other factors to determine whether the set is an operation. Those factors include, but are not limited to, whether the set:
- (a) Has begun planned principal activities;
  - (b) Has employees, intellectual property and other inputs and processes that could be applied to those inputs;
  - (c) Is pursuing a plan to produce outputs; and
  - (d) Will be able to obtain access to service recipients that will receive the outputs.
- Not all of those factors need to be present for a particular integrated set of activities and assets and/or liabilities in the development stage to qualify as an operation.
- AG8. Determining whether a particular set of activities and assets and/or liabilities is an operation should be based on whether the integrated set is capable of being conducted and managed as an operation by another entity. Thus, in evaluating whether a particular set is an operation, it is not relevant whether a transferor operated the set as an operation or whether the acquirer intends to operate the set as an operation.
- AG9. In the absence of evidence to the contrary, a particular set of activities and assets and/or liabilities in which goodwill is present shall be presumed to be an operation. However, an operation need not have goodwill.

#### **Classification of PBE Combinations (see paragraphs 7–14)**

##### *Assessment of Control (see paragraphs 7–8)*

- AG10. Where a party to a PBE combination gain controls of one or more operations as a result of that combination, the combination is classified as either an amalgamation or an acquisition, depending on the economic substance of the combination. If no party to the combination gains control, the combination is classified as an amalgamation. In making this assessment the first step is to determine whether one of the entities that existed prior to the PBE combination has gained control of one or more operations. Because this determination is made by reference to the entities that existed prior to the PBE combination, it differs from the assessment of control made in accordance with PBE IPSAS 35 *Consolidated Financial Statements*, where the assessment of control is made by reference to the entities that exist after a PBE combination has taken place.
- AG11. In determining whether one party to a PBE combination gains control of one or more operations as a result of the combination, an entity applies the principles and guidance in PBE IPSAS 35. In applying the principles and guidance, references to “an entity controls” are read as “an entity gains control of” and references to “another entity” are read as “an operation”. For example, in determining whether one party to a PBE combination gains control of one or more operations as a result of the combination for the purposes of this Standard, paragraph 20 of PBE IPSAS 35 should be read as follows (amended text is shown in italics):

Thus, an entity *gains control of an operation* if and only if the entity *gains* all the following:

- (a) Power over the operation (see paragraphs 23–29);
- (b) Exposure, or rights, to variable benefits from its involvement with the operation (see paragraphs 30–34); and
- (c) The ability to use its power over the operation to affect the nature or amount of the benefits from its involvement with the operation (see paragraphs 35–37).

- AG12. In applying the principles and guidance in PBE IPSAS 35, an entity has regard to paragraphs AG13–AG18.
- AG13. A PBE combination effected primarily by the transfer of consideration (i.e., by transferring cash or other assets or by incurring liabilities) usually results in one entity gaining control of one or more operations.

- AG14. A PBE combination effected primarily by exchanging equity interests usually results in one entity gaining control of one or more operations. Combinations involving an exchange of equity interests usually results in one entity having sufficient voting rights to gain control of one or more operations. This may occur without the entity having a majority of the voting rights where the entity has a large minority voting interest and no other owner or organised group of owners has a significant voting interest. Other pertinent facts and circumstances shall also be considered in assessing whether one entity (and, if so, which entity) has gained control of one or more operations, including:
- (a) The composition of the governing body of the combined operation – The acquirer is usually the combining operation whose owners have the ability to elect a majority of the members of the governing body of the combined operations.
  - (b) The composition of the senior management of the combined operation – The acquirer is usually the combining operation whose (former) management dominates the management of the combined operations.
- AG15. A PBE combination involving the issuance of equity interests may give rise to a reverse acquisition (see paragraphs AG66–AG71). An entity considers this possibility in determining whether one party to a PBE combination gains control of operations.
- AG16. In a PBE combination involving more than two entities, the party to the PBE combination that initiates the combination (if any) is more likely to gain control of operations than the other parties to the combination.
- AG17. In a PBE combination in which a new entity is formed to effect the combination, but the combination is not effected by exchanging equity interests (see paragraph AG14), that new entity may gain control of operations only where it exists prior to the combination taking place. Where this new entity does not exist prior to the combination taking place, an entity considers other pertinent facts and circumstances (see paragraph AG14) in deciding whether one of the parties to the combination that existed prior to the combination taking place gains control of operations.
- AG17.1 A PBE combination in which operations not under common control voluntarily agree to combine could be classified as either an amalgamation or an acquisition. The operations could combine to improve services to their recipients or to reduce operating costs. In this type of combination, if the combining operations are uniting rather than one party gaining control of the other party, this could be classified as an amalgamation. This type of combination is more frequent in the not-for-profit sector than the public sector.
- AG18. If the application of this guidance identifies one party to the combination as gaining control of one or more operations, the combination is classified as either an amalgamation or an acquisition, depending on the economic substance of the combination. An entity considers the guidance in paragraphs 9–14 and AG19–AG50 to determine whether the economic substance of the combination is that of an amalgamation. If the application of the guidance does not identify one party to the combination as gaining control of one or more operations, the combination shall be classified as an amalgamation.

*Assessment of the Classification of a PBE Combination (see paragraphs 9–14)*

- AG19. If one party to a PBE combination gains control of one or more operations as a result of the combination, the combination shall be classified as either an amalgamation or an acquisition, depending on the economic substance of the combination. In assessing whether the economic substance of the combination is that of an amalgamation, an entity considers the economic substance of the PBE combination and the indicators in paragraphs 12–14. A combination that does not have the economic substance of an amalgamation shall be classified as an acquisition. In making this assessment, an entity considers the following guidance.

Economic Substance (see paragraph 9)

- AG20. Usually, an analysis of the indicators in paragraphs 12–13, individually or on combination, will produce a conclusive result and provide sufficient evidence to determine whether the economic substance of the combination is that of an amalgamation. A combination does not need to satisfy both of these indicators to be classified as an amalgamation.



- AG21. Where consideration of the indicators in paragraphs 12–13 produces inconclusive results or does not provide sufficient evidence to clearly determine the economic substance of the combination, an entity considers the additional matters in paragraph 14.
- AG22. [Not used]
- AG23. An amalgamation involves the integration of the operations that are part of the PBE combination. Generally, an amalgamation does not give rise to a controlling entity/controlled entity relationship between parties to a combination. If, following the combination, any of the operations operate as controlled entities of a party to the combination, this may provide evidence that the economic substance of the combination is that of an acquisition. However, there could be circumstances where a controlling entity/controlled entity relationship between parties to a combination remains after the combination. For example, there could be legal, tax or administrative reasons for leaving the existing operations of the combining operations within their respective existing legal entity structure, which could entail establishing a controlled entity/controlling entity structure as part of the combination, but that outcome does not necessarily mean that the economic substance of the combination is an acquisition.
- AG24. An acquisition is usually a mutual agreement between two or more parties, and usually has commercial substance. However, it is possible for an acquisition to occur without mutual agreement (for example, a forced nationalisation).
- AG25. [Not used]

Indicator Relating to Consideration (see paragraph 12)

- AG26. Amalgamations usually do not involve the payment of consideration to compensate a seller for giving up its entitlement to the net assets of an operation. By contrast, acquisitions usually involve an exchange of consideration between those gaining control of the operations and those losing control of the operations.
- AG27. However, there may be a number of reasons why consideration is either paid or not paid. In assessing the impact of consideration on the classification of a combination as an acquisition or an amalgamation, it is necessary to consider those reasons.
- AG28. The payment of consideration to compensate those with an entitlement to the net assets of the transferred operation for giving up that entitlement provides evidence that the economic substance of the PBE combination is an acquisition. In such cases, the combination is classified as an acquisition. If consideration is paid for reasons other than to compensate the seller for giving up its entitlement to the net assets of an operation, (for example, to reimburse the seller for costs incurred in effecting the PBE combination), this may provide evidence that the economic substance of the combination is that of an amalgamation.
- AG29. The absence of consideration does not in itself provide evidence of the economic substance of the PBE combination. Acquisitions may occur without an exchange of consideration. If those with an entitlement to the net assets of an operation have voluntarily given up their entitlement in order to donate the net assets of the operation to an unrelated entity (for example, an individual bequeaths an operation to a government entity) this would suggest that the combination is an acquisition. If those with an entitlement to the net assets of an operation have their entitlement extinguished through compulsion (for example, in an uncompensated seizure by a public sector entity), this would suggest that the combination is an acquisition.
- AG30. In contrast, if there was no compensation paid because the combining operations are under common control and hence no compensation is necessary, this would suggest that the combination is an amalgamation. Similarly, in a combination that occurs as part of a local government reorganisation, the payment of compensation may not be necessary because the citizens served by the combining operations will continue to be served by the combined operations, which would suggest that the combination is an amalgamation.
- AG31. [Not used]

Indicators Relating to the Decision-Making Process (see paragraph 13)

- AG32. An acquisition usually requires the voluntary participation of all the parties to the combination. Consequently, where a PBE combination is imposed by a third party without any party to the

combination being involved in the decision-making process, this may provide evidence that the economic substance of the combination is an amalgamation.

- AG33. In other circumstances, the parties to the PBE combination will be able to influence the terms of the combination to different degrees even when the combination is imposed by a third party. As the degree of influence the parties to the combination have increases, particularly the influence of the party that gains control of one or more operations, it becomes less likely that a conclusion regarding the economic substance of the combination can be drawn.
- AG34. For example, the parties to the combination may be directed to combine by a regulator, but the regulator allows the parties to determine the terms of the combination. The economic substance of this PBE combination is likely to be determined by the terms of the combination agreed by the parties rather than by the decision of the regulator that the parties must combine.
- AG35. Where the party to the PBE combination that gains control of one or more operations is able to impose the combination on the other party, this does not provide evidence that the economic substance of the combination is that of an amalgamation. For example, a government may decide to nationalise a private sector entity, contrary to the wishes of the shareholders. The fact that the government (a party to the combination) is able to impose the nationalisation, for example through legislation, does not provide evidence that the economic substance of the combination is an amalgamation. Where the party to the combination that gains control of one or more operations is able to impose the combination on the other party, this provides evidence that the economic substance of the combination is that of an acquisition.
- AG36. Where a PBE combination is subject to approval by each party's citizens through referenda, this may provide evidence that the economic substance of the combination is that of an amalgamation. Such a requirement provides evidence that the parties to the combination do not have freedom to voluntarily effect the combination and that the ultimate decision as to whether the combination takes place is taken by third parties. However, it is possible for citizens to approve, through referenda, a combination whose terms are those of an acquisition.
- AG37. Where a PBE combination takes place between two parties that are under common control, this may provide evidence that the economic substance of the combination is that of an amalgamation. PBE combinations under common control are often instigated by and on behalf of the controlling entity, and the controlling entity will often determine the terms of the combination. For example, a government may decide to combine two ministries for administrative or political reasons, and specify the terms of the combination. In such circumstances, the ultimate decision as to whether the combination takes place, and the terms of the combination, are determined by the controlling entity. This provides evidence that the economic substance of the combination is an amalgamation.
- AG38. In some circumstances, two operations under common control may agree to combine voluntarily. However, this decision will usually be subject to the approval of the controlling entity, whether this approval is given explicitly or not. Where the approval of the controlling entity is required, this provides evidence that the ultimate decision as to whether the combination takes place, and the terms of the combination, are determined by the controlling entity. Consequently, this provides evidence that the economic substance of the combination is that of an amalgamation.
- AG39. Only where there is no evidence that the controlling entity is involved in the PBE combination, either by instigating the combination, determining the terms of the combination, or approving (whether explicitly or implicitly) the combination, will there be no evidence that the economic substance of the combination is that of an amalgamation. In such circumstances, the entity considers all other factors in determining the classification of the PBE combination.

Additional Matters to be Considered where the Indicators Relating to Consideration and the Decision-Making Process do not Provide Sufficient Evidence to Determine whether the Economic Substance of the Combination is that of an Amalgamation (see paragraph 14)

- AG40. Where an analysis of the indicators relating to consideration and the decision-making process produces inconclusive results or does not provide sufficient evidence to determine whether the economic substance of the combination is that of an amalgamation, an entity considers which classification and resulting accounting treatment would provide information that:
- (a) Best meets the objectives of financial reporting; and

(b) Best satisfies the qualitative characteristics (QCs).

- AG41. An analysis of the indicators relating to consideration and the decision-making process will usually produce a conclusive result and provide sufficient evidence to determine whether the economic substance of the combination is that of an amalgamation. This is because the indicators relating to consideration and the decision-making process will provide evidence of the economic substance of a PBE combination in all but exceptional circumstances. As a result, where it is clear that the indicators have been met, the additional matters set out in paragraph 14 are not considered in determining the classification.
- AG42. Where an analysis of the indicators relating to consideration and the decision-making process provides inconclusive results or does not provide sufficient evidence to determine whether the economic substance of the combination is that of an amalgamation, an entity considers which classification would provide information that best meets the objectives of financial reporting. The determination of whether a PBE combination is classified as an acquisition or an amalgamation can significantly affect the financial reporting of the combination. Consequently, it is important to consider the information each method provides and the principal users of that information.
- AG43. The modified pooling of interests method views the combination from the perspective of each of the combining operations and their owners or constituents who are uniting their interests in the resulting entity. Using the modified pooling of interests method of accounting, the combining operations measure the reported assets and liabilities at their carrying amounts in the financial statements of the combining operations as of the amalgamation date. Such information may assist users in assessing the performance of the resulting entity based upon the combined historical assets and liabilities of the combining operations at the date of the amalgamation and in comparing operating results with prior periods. However, this comparability may be reduced where adjustments to achieve consistent accounting policies are required.
- AG44. The acquisition method views a combination from the perspective of the acquirer—the entity that gains control of the other operations. The acquirer purchases or otherwise gains control over net assets and recognises in its financial statements the assets acquired and liabilities assumed, including those not previously recognised by the acquired operation. Such information assists users of the financial statements in assessing the initial investments made, where paid, and the subsequent performance of those investments and comparing them with the performance of other entities based on the investment made by the acquirer. While it revalues the assets and liabilities of the acquired operation, it does not affect the valuation of assets and liabilities held by the acquirer prior to the acquisition. Further, depending on the relationship between the amounts in paragraph 85(a) and 85(b) and other factors (for example, a bargain purchase), it may result in the immediate recognition of a gain or loss through surplus or deficit.
- AG45. The information provided by each approach is summarised in the following table.

	<b>Amalgamation</b>	<b>Acquisition</b>
Perspective	Perspective of each of the combining operations and their owners or constituents.	Perspective of the acquirer.
User information	Assists users of the financial statements in assessing the performance of the resulting entity based upon the combined historical assets and liabilities of the combining operations at the date of the amalgamation and in comparing operating results with prior periods.	Assists users of the financial statements in assessing the initial investments made, where paid, and the subsequent performance of those investments.

	<b>Amalgamation</b>	<b>Acquisition</b>
Basis of reported values	Measures the reported assets and liabilities at their carrying amounts in the financial statements of the combining operations as of the amalgamation date.	Revalues the identifiable assets and liabilities of the acquired operation but does not affect the valuation of assets and liabilities held by the acquirer.
Ability to compare to operating results of prior periods	May facilitate the comparison of operating results with prior periods. Comparability may be reduced where adjustments to achieve consistent accounting policies are required.	Difficult to compare operating results with prior periods.

- AG46. Consideration of which classification would provide information that best meets the objectives of financial reporting provides evidence of the economic substance of the PBE combination where an analysis of the indicators relating to consideration and the decision-making process provides inconclusive results or does not provide sufficient evidence to determine whether the economic substance of the combination is that of an amalgamation.
- AG47. Where an analysis of the indicators relating to consideration and the decision-making process provides inconclusive results or does not provide sufficient evidence to determine the classification of the combination, an entity considers which classification would provide information that best satisfies the QCs of relevance, faithful representation, understandability, timeliness, comparability and verifiability. In making this assessment, an entity also considers the constraints on information included in general purpose financial reports, which are materiality, cost-benefit and the balance between the QCs.
- AG48. When considering the classification of a PBE combination, some QCs will be more significant than others. For example, timeliness will be less significant than understandability when considering whether a combination is an amalgamation or an acquisition.
- AG49. An entity considers the QCs and the constraints on information from the perspective of the users of the financial statements. This will include consideration of the following questions; this list is not exhaustive.
- (a) Which classification most faithfully represents the economic substance of the PBE combination, which may be different from its legal form? Does that classification faithfully represent an entity's financial performance and financial position?
  - (b) Which classification will help users understand the nature of the PBE combination? For example, in an amalgamation, any difference between the total recognised assets and total recognised liabilities is recognised in net assets/equity, whereas in an acquisition, the acquirer recognises goodwill, or a gain or loss in the reporting period. Which approach best helps the user to understand the nature of the combination?
  - (c) Users' needs are best served when the information provided in respect of a transaction is comparable. How are similar PBE combinations classified?
- AG50. Consideration of which classification would provide information that best meets the QCs provides evidence of the economic substance of the PBE combination where an analysis of the indicators relating to consideration and the decision-making process provides inconclusive results or does not provide sufficient evidence to determine whether the economic substance of the combination is that of an amalgamation.

## Accounting for Amalgamations

### *Combining Operations that Have not Previously Applied PBE Standards (see paragraph 20.1)*

AG50.1 Where the resulting entity is a continuing reporting entity and has previously applied PBE Standards prior to the amalgamation but one or more of the combining operations have not previously applied PBE Standards prior to the amalgamation, the resulting entity shall:

- (a) Prepare an opening statement of financial position as at the amalgamation date (this shall be the date of transition to PBE Standards) in accordance with paragraphs 10–23 of PBE FRS 47 *First-time Adoption of PBE Standards by Entities Other Than Those Previously Applying NZ IFRS* for each of the combining operations that have not previously applied PBE Standards; and
- (b) Use the same accounting policies for those combining operations as are already being applied by the continuing reporting entity.

After preparing the combining operations' statements of financial position the resulting entity shall then apply the requirements in paragraphs 21–35.

AG50.2 Where the resulting entity is a new reporting entity and one or more of the combining operations have not previously applied PBE Standards prior to the amalgamation, the resulting entity shall:

- (a) Apply XRB A1 *Application of the Accounting Standards Framework* to determine the appropriate tier of reporting for the resulting entity. It shall not apply the requirements for moving between tiers in XRB A1 as it was not in existence as a reporting entity prior to the amalgamation;
- (b) Prepare an opening statement of financial position as at the amalgamation date (this shall be the date of transition to PBE Standards) in accordance with paragraphs 10–23 of PBE FRS 47 for each of the combining operations that have not previously applied PBE Standards; and
- (c) Use the same accounting policies as were previously used by those combining operations that have previously applied PBE Standards.

After preparing the combining operations' statements of financial position the resulting entity shall then apply the requirements in paragraphs 21–35.

### *Eliminating Transactions Between the Combining Operations (see paragraph 22)*

AG51. A resulting entity eliminates the effects of all transactions between the combining operations. For many transactions, elimination will take place automatically. For example, one combining operation provided services for a fee to another combining operation prior to the amalgamation date. The revenue of the combining operation that provided the services is reflected in that combining operation's accumulated comprehensive revenue and expense at the amalgamation date. The expense of the combining operation receiving the services is reflected in that combining operation's accumulated comprehensive revenue and expense at the amalgamation date. The resulting entity will recognise both amounts in net assets/equity.

AG52. Elimination may not take place automatically where one combining operation has recognised an asset, and another combining operation has recognised a corresponding liability as a result of the transaction between two combining operations. The resulting entity eliminates both the asset and the liability, and recognises any difference between the asset and liability in net assets/equity.

### *Carrying Amounts to be Used (see paragraphs 26–27)*

AG53. [Not used]

AG54. To meet the requirements in paragraphs 26–27, a resulting entity measures the assets and liabilities of the combining operations at their carrying amounts in the financial statements of the combining operations as of the amalgamation date, subject to the requirement to adjust the carrying amounts to conform to the resulting entity's accounting policies.

### *Accounting Policies to be Used (see paragraph 28)*

AG54.1 Where the resulting entity is a new reporting entity and the combining operations have applied different accounting policies for similar transactions and events, the resulting entity shall select the accounting

policies that result in the financial statements providing the most relevant and faithfully representative information, subject to the requirements in paragraphs 31–35. If a resulting entity has transactions, other events or conditions that differ in substance from those previously occurring, that did not previously occur, or that were previously immaterial, it shall select or develop accounting policies in accordance with PBE IPSAS 3 *Accounting Policies, Changes in Accounting Estimates and Errors*.

AG54.2 Where the resulting entity is a continuing reporting entity, it shall continue to apply its previous accounting policies to transactions and events, subject to the requirements in paragraphs 31–35. There are some limited circumstances in which a resulting entity that is a continuing reporting entity may need to apply PBE IPSAS 3 in preparing its first set of financial statements following the amalgamation. These include:

- (a) The identification of a prior period error, in which case PBE IPSAS 3 (paragraphs 46–54) applies; or
- (b) The resulting entity voluntarily changes an accounting policy, including the selection of a different option permitted under PBE Standards, in which case PBE IPSAS 3 (paragraphs 17–34) applies; or
- (c) The resulting entity will have transactions, other events or conditions that differ in substance from those previously occurring, that did not previously occur, or that were previously immaterial, in which case PBE IPSAS 3 (paragraphs 9–15) applies.

*Licences and Similar Rights Previously Granted by One Combining Operation to Another Combining Operation (see paragraph 32)*

AG55. As part of an amalgamation, a resulting entity may receive a licence or similar right that had previously been granted by one combining operation to another combining operation to use one or more of the grantor's recognised or unrecognised assets. Examples of such rights include a right to use the acquirer's technology under a technology licencing agreement. The resulting entity recognises this licence or similar right as an identifiable intangible asset, and measures the intangible asset at its carrying amount in the financial statements of the combining operation as of the amalgamation date. Because the licence or similar right has previously been part of a binding arrangement, the licence satisfies both the separability and binding arrangement criteria in PBE IPSAS 31 *Intangible Assets*. Paragraph 47 provides guidance on the subsequent accounting for a licence or similar right previously granted by one combining operation to another combining operation.

AG56. The resulting entity assesses both the licence or similar right previously granted by one combining operation to another combining operation, and the underlying asset (where the underlying asset is a recognised asset) for impairment in accordance with PBE IPSAS 21 *Impairment of Non-Cash-Generating Assets* and/or PBE IPSAS 26 *Impairment of Cash-Generating Assets*, at the amalgamation date.

*Forgiveness of Amounts of Tax Due in an Amalgamation (where Included in the Terms of the Amalgamation) (see paragraph 33)*

AG57. The resulting entity shall not recognise any amounts in respect of a combining operation's tax due where these amounts have been forgiven by a tax authority as part of the terms of the amalgamation. Where tax forgiveness occurs subsequent to an amalgamation, the resulting entity applies the requirements in paragraph 49. In applying the modified pooling of interests method of accounting, the resulting entity shall treat those amounts included in the terms of the amalgamation as having been derecognised prior to the amalgamation. The resulting entity shall account for a combining operation's tax due that has not been forgiven by a tax authority in accordance with PBE IAS 12.

AG58. [Not used]

*Recognition of Goodwill (see paragraph 36)*

AG59. Amalgamations do not give rise to goodwill, and consequently a resulting entity does not recognise goodwill arising from an amalgamation. Paragraphs 37–38 specify the treatment of the net assets/equity arising as a result of the amalgamation.

AG60. Where a combining operation has previously recognised goodwill as a result of a previous acquisition, the resulting entity recognises this goodwill in its opening statement of financial position.

*Subsequent Measurement of Transfers, Concessionary Loans and Similar Benefits Received by a Combining Operation on the Basis of Criteria that may Change as a Result of an Amalgamation (see paragraph 48)*

AG61. Prior to an amalgamation taking place, a combining operation may receive a transfer from a third party, based on specified criteria. For example, a national government may provide grants to those municipalities where the average household income is below a threshold. An amalgamation of two municipalities may involve one municipality which met the criteria and received the grant, and one municipality which did not meet the criteria and which did not receive the grant. Following the amalgamation, the average household income of the new, combined municipality will either be above or below the threshold, which may cause the grantor to reassess the amount of grant given.

AG62. The resulting entity shall not account for any revisions to the grant amount as part of the amalgamation, but shall account for any revisions at the point the grantor makes its intentions known in accordance with other PBE Standards.

AG63. Similar circumstances may arise in respect of concessionary loans and other benefits. The resulting entity shall not account for any revisions to those transactions as part of the amalgamation, but shall account for any revisions at the point the grantor makes its intentions known in accordance with other PBE Standards.

*Amalgamations Occurring During a Reporting Period (see paragraphs 50–52)*

AG64. To meet the requirements of paragraphs 50–52, the resulting entity is not required to present financial statements of the combining operations for periods prior to the amalgamation date, although it may elect to do so by making the disclosures specified in paragraph 54(g). Where the resulting entity does not elect to present financial statements of the combining operations for periods prior to the amalgamation date, it meets the needs of the users of its financial statements for information about the combining operations prior to the amalgamation in one of two ways:

- (a) Directing the users of its financial statements to the financial statements issued on behalf of each of the combining operations. This is appropriate where financial statements have been issued on behalf of the combining operations for a reporting period ending immediately prior to the amalgamation date (which may be a partial period).
- (b) Making the disclosures required by paragraph 54(h) in respect of each of the combining operations. This is appropriate where no financial statements have been issued on behalf of the combining operations for a reporting period ending immediately prior to the amalgamation date (which may be a partial period).

AG65. [Not used]

## **Accounting for Acquisitions**

### *Reverse Acquisitions*

AG66. A reverse acquisition occurs when the entity that issues securities (the legal acquirer) is identified as the acquired operation for accounting purposes on the basis of the guidance in paragraphs AG10–AG18. The entity whose equity interests are acquired (the legal acquired operation) must be the acquirer for accounting purposes for the transaction to be considered a reverse acquisition. For example, reverse acquisitions sometimes occur when an unlisted entity wants to become a listed entity but does not want to register its equity shares. To accomplish that, the unlisted entity will arrange for a listed entity to acquire its equity interests in exchange for the equity interests of the listed entity. In this example, the listed entity is the legal acquirer because it issued its equity interests, and the unlisted entity is the legal acquired operation because its equity interests were acquired. However, application of the guidance in paragraphs AG10–AG18 results in identifying:

- (a) The listed entity as the acquired operation for accounting purposes (the accounting acquired operation)—i.e., the listed entity does not gain control of one or more operations; and
- (b) The unlisted entity as the acquirer for accounting purposes (the accounting acquirer)—i.e., the unlisted entity does gain control of one or more operations.

The accounting acquired operation must meet the definition of an operation for the transaction to be accounted for as a reverse acquisition, and all of the recognition and measurement principles in this Standard, including the requirement to recognise goodwill, apply.

#### Measuring the Consideration Transferred

AG67. In a reverse acquisition, the accounting acquirer usually issues no consideration for the acquired operation. Instead, the accounting acquired operation usually issues its equity shares to the owners of the accounting acquirer. Accordingly, the acquisition-date fair value of the consideration transferred by the accounting acquirer for its interest in the accounting acquired operation is based on the number of equity interests the legal controlled entity would have had to issue to give the owners of the legal controlling entity the same percentage equity interest in the combined entity that results from the reverse acquisition. The fair value of the number of equity interests calculated in that way can be used as the fair value of consideration transferred in exchange for the acquired operation.

#### Preparation and Presentation of Consolidated Financial Statements

AG68. Consolidated financial statements prepared following a reverse acquisition are issued under the name of the legal controlling entity (accounting acquired operation) but described in the notes as a continuation of the financial statements of the legal controlled entity (accounting acquirer), with one adjustment, which is to adjust retroactively the accounting acquirer's legal capital to reflect the legal capital of the accounting acquired operation. That adjustment is required to reflect the capital of the legal controlling entity (the accounting acquired operation). Comparative information presented in those consolidated financial statements also is retroactively adjusted to reflect the legal capital of the legal controlling entity (accounting acquired operation).

AG69. Because the consolidated financial statements represent the continuation of the financial statements of the legal controlled entity except for its capital structure, the consolidated financial statements reflect:

- (a) The assets and liabilities of the legal controlled entity (the accounting acquirer) recognised and measured at their pre-combination carrying amounts.
- (b) The assets and liabilities of the legal controlling entity (the accounting acquired operation) recognised and measured in accordance with this Standard.
- (c) The accumulated comprehensive revenue and expense and other equity balances of the legal controlled entity (accounting acquirer) before the acquisition.
- (d) The amount recognised as issued equity interests in the consolidated financial statements determined by adding the issued equity interest of the legal controlled entity (the accounting acquirer) outstanding immediately before the acquisition to the fair value of the legal controlling entity (accounting acquired operation). However, the equity structure (i.e., the number and type of equity interests issued) reflects the equity structure of the legal controlling entity (the accounting acquired operation), including the equity interests the legal controlling entity issued to effect the acquisition. Accordingly, the equity structure of the legal controlled entity (the accounting acquirer) is restated using the exchange ratio established in the acquisition agreement to reflect the number of shares of the legal controlling entity (the accounting acquired operation) issued in the reverse acquisition.
- (e) The non-controlling interest's proportionate share of the legal controlled entity's (accounting acquirer's) pre-acquisition carrying amounts of accumulated comprehensive revenue and expense and other equity interests as discussed in paragraphs AG70 and AG71.

#### Non-Controlling Interest

AG70. In a reverse acquisition, some of the owners of the legal acquired operation (the accounting acquirer) might not exchange their equity interests for equity interests of the legal controlling entity (the accounting acquired operation). Those owners are treated as a non-controlling interest in the consolidated financial statements after the reverse acquisition. That is because the owners of the legal acquired operation that do not exchange their equity interests for equity interests of the legal acquirer have an interest in only the results and net assets of the legal acquired operation—not in the results and net assets of the combined entity. Conversely, even though the legal acquirer is the acquired operation



for accounting purposes, the owners of the legal acquirer have an interest in the results and net assets of the combined entity.

- AG71. The assets and liabilities of the legal acquired operation are measured and recognised in the consolidated financial statements at their pre-combination carrying amounts (see paragraph AG69(a)). Therefore, in a reverse acquisition the non-controlling interest reflects the non-controlling shareholders' proportionate interest in the pre-acquisition carrying amounts of the legal acquired operation's net assets even if the non-controlling interests in other acquisitions are measured at their fair value at the acquisition date.

*Recognising Particular Assets Acquired and Liabilities Assumed in an Acquisition (see paragraphs 64–68)*

#### Operating Leases

- AG72. The acquirer shall recognise no assets or liabilities related to an operating lease in which the acquired operation is the lessee except as required by paragraphs AG73–AG74.
- AG73. The acquirer shall determine whether the terms of each operating lease in which the acquired operation is the lessee are favourable or unfavourable. The acquirer shall recognise an intangible asset if the terms of an operating lease are favourable relative to market terms and a liability if the terms are unfavourable relative to market terms. Paragraph AG89 provides guidance on measuring the acquisition-date fair value of assets subject to operating leases in which the acquired operation is the lessor.
- AG74. An identifiable intangible asset may be associated with an operating lease, which may be evidenced by market participants' willingness to pay a price for the lease even if it is at market terms. For example, a lease of gates at an airport or of retail space in a prime shopping area might provide entry into a market or other future economic benefits or service potential that qualify as identifiable intangible assets, for example, as a relationship with users of a service. In that situation, the acquirer shall recognise the associated identifiable intangible asset(s) in accordance with paragraph AG75.

#### Intangible Assets

- AG75. The acquirer shall recognise, separately from goodwill, the identifiable intangible assets acquired in an acquisition. An intangible asset is identifiable if it meets either the separability criterion or the binding arrangement criterion.
- AG76. An intangible asset that meets the binding arrangement criterion is identifiable even if the asset is not transferable or separable from the acquired operation or from other rights and obligations. For example:
- (a) An acquired operation leases a facility under an operating lease that has terms that are favourable relative to market terms. The lease terms explicitly prohibit transfer of the lease (through either sale or sublease). The amount by which the lease terms are favourable compared with the terms of current market transactions for the same or similar items is an intangible asset that meets the binding arrangement criterion for recognition separately from goodwill, even though the acquirer cannot sell or otherwise transfer the lease arrangement.
  - (b) An acquired operation owns and operates a nuclear power plant. The licence to operate that power plant is an intangible asset that meets the binding arrangement criterion for recognition separately from goodwill, even if the acquirer cannot sell or transfer it separately from the acquired power plant. An acquirer may recognise the fair value of the operating licence and the fair value of the power plant as a single asset for financial reporting purposes if the useful lives of those assets are similar.
  - (c) An acquired operation owns a technology patent. It has licensed that patent to others for their exclusive use outside the domestic market, receiving a specified percentage of future foreign revenue in exchange. Both the technology patent and the related licence agreement meet the binding arrangement criterion for recognition separately from goodwill even if selling or exchanging the patent and the related licence agreement separately from one another would not be practical.
- AG77. The separability criterion means that an acquired intangible asset is capable of being separated or divided from the acquired operation and sold, transferred, licensed, rented or exchanged, either individually or together with a related binding arrangement, identifiable asset or liability. An intangible

asset that the acquirer would be able to sell, license or otherwise exchange for something else of value meets the separability criterion even if the acquirer does not intend to sell, license or otherwise exchange it. An acquired intangible asset meets the separability criterion if there is evidence of exchange transactions for that type of asset or an asset of a similar type, even if those transactions are infrequent and regardless of whether the acquirer is involved in them. For example, lists of users of a service are frequently licensed and thus meet the separability criterion. Even if an acquired operation believes its lists of users of a service have characteristics different from other lists of users of a service, the fact that lists of users of a service are frequently licensed generally means that the acquired list of users of a service meets the separability criterion. However, a list of users of a service acquired in an acquisition would not meet the separability criterion if the terms of confidentiality or other agreements prohibit an entity from selling, leasing or otherwise exchanging information about its users of a service.

- AG78. An intangible asset that is not individually separable from the acquired operation or combined entity meets the separability criterion if it is separable in combination with a related binding arrangement, identifiable asset or liability. For example, an acquired operation owns a registered trademark and documented but unpatented technical expertise used to manufacture the trademarked product. To transfer ownership of a trademark, the owner is also required to transfer everything else necessary for the new owner to produce a product or service indistinguishable from that produced by the former owner. Because the unpatented technical expertise must be separated from the acquired operation or combined entity and sold if the related trademark is sold, it meets the separability criterion.

#### Reacquired Rights

- AG79. As part of an acquisition, an acquirer may reacquire a right that it had previously granted to the acquired operation to use one or more of the acquirer's recognised or unrecognised assets. Examples of such rights include a right to use the acquirer's trade name under a network or partner agreement or a right to use the acquirer's technology under a technology licensing agreement. A reacquired right is an identifiable intangible asset that the acquirer recognises separately from goodwill or a gain from a bargain purchase. Paragraph 83 provides guidance on measuring a reacquired right and paragraph 113 provides guidance on the subsequent accounting for a reacquired right.
- AG80. If the terms of the binding arrangement giving rise to a reacquired right are favourable or unfavourable relative to the terms of current market transactions for the same or similar items, the acquirer shall recognise a settlement gain or loss. Paragraph AG100 provides guidance for measuring that settlement gain or loss.

#### Assembled Workforce and Other Items that are not Identifiable

- AG81. The acquirer subsumes into goodwill the value of an acquired intangible asset that is not identifiable as of the acquisition date. For example, an acquirer may attribute value to the existence of an assembled workforce, which is an existing collection of employees that permits the acquirer to continue to operate an acquired operation from the acquisition date. An assembled workforce does not represent the intellectual capital of the skilled workforce—the (often specialised) knowledge and experience that employees of an acquired operation bring to their jobs. Because the assembled workforce is not an identifiable asset to be recognised separately from goodwill or a gain from a bargain purchase, any value attributed to it is subsumed into goodwill or a gain from a bargain purchase.
- AG82. The acquirer also subsumes into goodwill or a gain from a bargain purchase any value attributed to items that do not qualify as assets at the acquisition date. For example, the acquirer might attribute value to potential binding arrangements the acquired operation is negotiating with prospective new customers at the acquisition date. Because those potential binding arrangements are not themselves assets at the acquisition date, the acquirer does not recognise them separately from goodwill or a gain from a bargain purchase. The acquirer should not subsequently reclassify the value of those binding arrangements from goodwill for events that occur after the acquisition date. However, the acquirer should assess the facts and circumstances surrounding events occurring shortly after the acquisition to determine whether a separately recognisable intangible asset existed at the acquisition date.
- AG83. After initial recognition, an acquirer accounts for intangible assets acquired in an acquisition in accordance with the provisions of PBE IPSAS 31. However, as described in paragraph 6 of PBE IPSAS 31, the accounting for some acquired intangible assets after initial recognition is prescribed by other PBE Standards.

AG84. The identifiability criteria determine whether an intangible asset is recognised separately from goodwill. However, the criteria neither provide guidance for measuring the fair value of an intangible asset nor restrict the assumptions used in measuring the fair value of an intangible asset. For example, the acquirer would take into account the assumptions that market participants would use when pricing the intangible asset, such as expectations of future renewals of binding arrangements, in measuring fair value. It is not necessary for the renewals themselves to meet the identifiability criteria. (However, see paragraph 83, which establishes an exception to the fair value measurement principle for reacquired rights recognised in an acquisition.) Paragraphs 39D and 39E of PBE IPSAS 31 provide guidance for determining whether intangible assets should be combined into a single unit of account with other intangible or tangible assets.

*Forgiveness of Amounts of Tax Due in an Acquisition (where Included in the Terms of the Acquisition)*  
(see paragraphs 78–79.2)

AG85. The acquirer shall not recognise any amounts in respect of an acquired operation's tax due where these amounts have been forgiven by a tax authority as part of the terms of the acquisition. Where tax forgiveness occurs subsequent to an acquisition, the resulting entity applies the requirements in paragraph 118. The acquirer shall account for an acquired operation's tax due that has not been forgiven by a tax authority in accordance with PBE IAS 12.

AG86. [Not used]

AG87. If, as a consequence of the terms of an acquisition, a tax authority forgives an amount of the acquirer's tax due, the acquirer shall derecognise those amounts in accordance with PBE IAS 12.

*Measuring the Fair Value of Particular Identifiable Assets and a Non-Controlling Interest in an Acquired Operation in an Acquisition (see paragraphs 72–73)*

Assets with Uncertain Cash Flows (Valuation Allowances)

AG88. The acquirer shall not recognise a separate valuation allowance as of the acquisition date for assets acquired in an acquisition that are measured at their acquisition-date fair values because the effects of uncertainty about future cash flows are included in the fair value measure. For example, because this Standard requires the acquirer to measure acquired receivables, including loans, at their acquisition-date fair values in accounting for an acquisition, the acquirer does not recognise a separate valuation allowance for the cash flows of the binding arrangement that are deemed to be uncollectible at that date.<sup>13</sup>

Assets Subject to Operating Leases in which the Acquired Operation is the Lessor

AG89. In measuring the acquisition-date fair value of an asset such as a building that is subject to an operating lease in which the acquired operation is the lessor, the acquirer shall take into account the terms of the lease. In other words, the acquirer does not recognise a separate asset or liability if the terms of an operating lease are either favourable or unfavourable when compared with market terms as paragraph AG73 requires for leases in which the acquired operation is the lessee.

Assets that the Acquirer Intends not to use or to use in a Way that is Different from the Way Other Market Participants would use them

AG90. To protect its competitive position, or for security or other reasons, the acquirer may intend not to use an acquired non-financial asset actively, or it may not intend to use the asset according to its highest and best use. For example, that might be the case for an acquired research and development intangible asset that the acquirer plans to use defensively by preventing others from using it. Nevertheless, the acquirer shall measure the fair value of the non-financial asset assuming its highest and best use by

<sup>13</sup> If an entity that applies this Standard and early adopts PBE IFRS 9, this paragraph should be read as follows:

The acquirer shall not recognise a separate valuation allowance as of the acquisition date for assets acquired in an acquisition that are measured at their acquisition-date fair values because the effects of uncertainty about future cash flows are included in the fair value measure. For example, because this Standard requires the acquirer to measure acquired receivables, including loans, at their acquisition-date fair values in accounting for an acquisition, the acquirer does not recognise a separate valuation allowance for the cash flows of the binding arrangement that are deemed to be uncollectible at that date. or a loss allowance for expected credit losses.

market participants in accordance with the appropriate valuation premise, both initially and when measuring fair value less costs of disposal for subsequent impairment testing.

#### Non-Controlling Interest in an Acquired Operation

- AG91. This Standard allows the acquirer to measure a non-controlling interest in the acquired operation at its fair value at the acquisition date. Sometimes an acquirer will be able to measure the acquisition-date fair value of a non-controlling interest on the basis of a quoted price in an active market for the equity shares (i.e., those not held by the acquirer). In other situations, however, a quoted price in an active market for the equity shares will not be available. In those situations, the acquirer would measure the fair value of the non-controlling interest using other valuation techniques.
- AG92. The fair values of the acquirer's interest in the acquired operation and the non-controlling interest on a per-share basis might differ. The main difference is likely to be the inclusion of a control premium in the per-share fair value of the acquirer's interest in the acquired operation or, conversely, the inclusion of a discount for lack of control (also referred to as a non-controlling interest discount) in the per-share fair value of the non-controlling interest if market participants would take into account such a premium or discount when pricing the non-controlling interest.

#### *Measuring Goodwill or a Gain from a Bargain Purchase in an Acquisition (see paragraphs 85–98)*

##### Relationship between Goodwill and Cash Flows (see paragraph 86)

- AG93. The acquirer shall recognise goodwill only to the extent that the acquirer estimates there will be favourable changes to its net cash flows, either from increased cash inflows or decreased cash outflows, and the goodwill relates to the acquisition of a cash-generating operation. An acquirer shall not recognise goodwill related to service potential other than cash flows nor goodwill related to the acquisition of a non-cash-generating operation.

##### Measuring the Acquisition-Date Fair Value of the Acquirer's Interest in the Acquired Operation Using Valuation Techniques (see paragraph 87)

- AG94. In an acquisition achieved without the transfer of consideration, the acquirer must substitute the acquisition-date fair value of its interest in the acquired operation for the acquisition-date fair value of the consideration transferred to measure goodwill, a loss or a gain on a bargain purchase (see paragraphs 85–87).

##### Special Considerations in Applying the Acquisition Method to Combinations of Mutual Entities (Application of paragraph 87)

- AG95. When two mutual entities combine, the fair value of the equity or member interests in the acquired operation (or the fair value of the acquired operation) may be more reliably measurable than the fair value of the member interests transferred by the acquirer. In that situation, paragraph 87 requires the acquirer to determine the amount of goodwill by using the acquisition-date fair value of the acquired operation's equity interests instead of the acquisition-date fair value of the acquirer's equity interests transferred as consideration. In addition, the acquirer in a combination of mutual entities shall recognise the acquired operation's net assets as a direct addition to capital or equity in its statement of financial position, not as an addition to accumulated comprehensive revenue and expense, which is consistent with the way in which other types of entities apply the acquisition method.
- AG96. Although they are similar in many ways to other entities, mutual entities have distinct characteristics that arise primarily because their members are both customers and owners. Members of mutual entities generally expect to receive benefits for their membership, often in the form of reduced fees charged for goods and services or patronage dividends. The portion of patronage dividends allocated to each member is often based on the amount of business the member did with the mutual entity during the year.
- AG97. A fair value measurement of a mutual entity should include the assumptions that market participants would make about future member benefits as well as any other relevant assumptions market participants would make about the mutual entity. For example, a present value technique may be used to measure the fair value of a mutual entity. The cash flows used as inputs to the model should be based on the

expected cash flows of the mutual entity, which are likely to reflect reductions for member benefits, such as reduced fees charged for goods and services.

*Determining what is Part of the Acquisition Transaction (see paragraphs 109–111)*

AG98. The acquirer should consider the following factors, which are neither mutually exclusive nor individually conclusive, to determine whether a transaction is part of the exchange for the acquired operation or whether the transaction is separate from the acquisition:

- (a) The reasons for the transaction. Understanding the reasons why the parties to the acquisition (the acquirer and the acquired operation and their owners, directors and managers—and their agents) entered into a particular transaction or arrangement may provide insight into whether it is part of the consideration transferred and the assets acquired or liabilities assumed. For example, if a transaction is arranged primarily for the benefit of the acquirer or the combined entity rather than primarily for the benefit of the acquired operation or its former owners before the combination, that portion of the transaction price paid (and any related assets or liabilities) is less likely to be part of the exchange for the acquired operation. Accordingly, the acquirer would account for that portion separately from the acquisition.
- (b) Who initiated the transaction. Understanding who initiated the transaction may also provide insight into whether it is part of the exchange for the acquired operation. For example, a transaction or other event that is initiated by the acquirer may be entered into for the purpose of providing future economic benefits to the acquirer or combined entity with little or no benefit received by the acquired operation or its former owners before the combination. On the other hand, a transaction or arrangement initiated by the acquired operation or its former owners is less likely to be for the benefit of the acquirer or the combined entity and more likely to be part of the acquisition transaction.
- (c) The timing of the transaction. The timing of the transaction may also provide insight into whether it is part of the exchange for the acquired operation. For example, a transaction between the acquirer and the acquired operation that takes place during the negotiations of the terms of an acquisition may have been entered into in contemplation of the acquisition to provide future economic benefits to the acquirer or the combined entity. If so, the acquired operation or its former owners before the acquisition are likely to receive little or no benefit from the transaction except for benefits they receive as part of the combined entity.

*Effective Settlement of a Pre-Existing Relationship between the Acquirer and Acquired Operation in an Acquisition (see paragraph 110(a))*

AG99. The acquirer and acquired operation may have a relationship that existed before they contemplated the acquisition, referred to here as a ‘pre-existing relationship’. A pre-existing relationship between the acquirer and acquired operation may arise from a binding arrangement (for example, vendor and customer or licensor and licensee) or may arise outside of a binding arrangement (for example, plaintiff and defendant).

AG100. If the acquisition in effect settles a pre-existing relationship, the acquirer recognises a gain or loss, measured as follows:

- (a) For a pre-existing relationship arising outside of a binding arrangement (such as a lawsuit), fair value.
- (b) For a pre-existing relationship arising from a binding arrangement, the lesser of (i) and (ii):
  - (i) The amount by which the binding arrangement is favourable or unfavourable from the perspective of the acquirer when compared with terms for current market transactions for the same or similar items. (An unfavourable binding arrangement is a binding arrangement that is unfavourable in terms of current market terms. It is not necessarily an onerous binding arrangement in which the unavoidable costs of meeting the obligations under the binding arrangement exceed the economic benefits expected to be received under it.)
  - (ii) The amount of any stated settlement provisions in the binding arrangement available to the counterparty to whom the binding arrangement is unfavourable.

If (ii) is less than (i), the difference is included as part of the acquisition accounting.

The amount of gain or loss recognised may depend in part on whether the acquirer had previously recognised a related asset or liability, and the reported gain or loss therefore may differ from the amount calculated by applying the above requirements.

- AG101. A pre-existing relationship may be a binding arrangement that the acquirer recognises as a reacquired right. If the binding arrangement includes terms that are favourable or unfavourable when compared with pricing for current market transactions for the same or similar items, the acquirer recognises, separately from the acquisition, a gain or loss for the effective settlement of the binding arrangement, measured in accordance with paragraph AG100.

Arrangements for Contingent Payments to Employees or Selling Shareholders (see paragraph 110(b))

- AG102. Whether arrangements for contingent payments to employees or selling shareholders are contingent consideration in the acquisition or are separate transactions depends on the nature of the arrangements. Understanding the reasons why the acquisition agreement includes a provision for contingent payments, who initiated the arrangement and when the parties entered into the arrangement may be helpful in assessing the nature of the arrangement.

- AG103. If it is not clear whether an arrangement for payments to employees or selling shareholders is part of the exchange for the acquired operation or is a transaction separate from the acquisition, the acquirer should consider the following indicators:

- (a) Continuing employment. The terms of continuing employment by the selling shareholders who become key employees may be an indicator of the substance of a contingent consideration arrangement. The relevant terms of continuing employment may be included in an employment agreement, acquisition agreement or some other document. A contingent consideration arrangement in which the payments are automatically forfeited if employment terminates is remuneration for post-combination services. Arrangements in which the contingent payments are not affected by employment termination may indicate that the contingent payments are additional consideration rather than remuneration.
- (b) Duration of continuing employment. If the period of required employment coincides with or is longer than the contingent payment period, that fact may indicate that the contingent payments are, in substance, remuneration.
- (c) Level of remuneration. Situations in which employee remuneration other than the contingent payments is at a reasonable level in comparison with that of other key employees in the combined entity may indicate that the contingent payments are additional consideration rather than remuneration.
- (d) Incremental payments to employees. If selling shareholders who do not become employees receive lower contingent payments on a per-share basis than the selling shareholders who become employees of the combined entity, that fact may indicate that the incremental amount of contingent payments to the selling shareholders who become employees is remuneration.
- (e) Number of shares owned. The relative number of shares owned by the selling shareholders who remain as key employees may be an indicator of the substance of the contingent consideration arrangement. For example, if the selling shareholders who owned substantially all of the shares in the acquired operation continue as key employees, that fact may indicate that the arrangement is, in substance, a profit-sharing arrangement intended to provide remuneration for post-combination services. Alternatively, if selling shareholders who continue as key employees owned only a small number of shares of the acquired operation and all selling shareholders receive the same amount of contingent consideration on a per-share basis, that fact may indicate that the contingent payments are additional consideration. The pre-acquisition ownership interests held by parties related to selling shareholders who continue as key employees, such as family members, should also be considered.
- (f) Linkage to the valuation. If the initial consideration transferred at the acquisition date is based on the low end of a range established in the valuation of the acquired operation and the contingent formula relates to that valuation approach, that fact may suggest that the contingent payments are additional consideration. Alternatively, if the contingent payment formula is

consistent with prior profit-sharing arrangements, that fact may suggest that the substance of the arrangement is to provide remuneration.

- (g) Formula for determining consideration. The formula used to determine the contingent payment may be helpful in assessing the substance of the arrangement. For example, if a contingent payment is determined on the basis of a multiple of earnings, that might suggest that the obligation is contingent consideration in the acquisition and that the formula is intended to establish or verify the fair value of the acquired operation. In contrast, a contingent payment that is a specified percentage of earnings might suggest that the obligation to employees is a profit-sharing arrangement to remunerate employees for services rendered.
- (h) Other agreements and issues. The terms of other arrangements with selling shareholders (such as agreements not to compete, executory contracts, consulting contracts and property lease agreements) and the income tax treatment of contingent payments may indicate that contingent payments are attributable to something other than consideration for the acquired operation. For example, in connection with the acquisition, the acquirer might enter into a property lease arrangement with a significant selling shareholder. If the lease payments specified in the lease arrangement are significantly below market, some or all of the contingent payments to the lessor (the selling shareholder) required by a separate arrangement for contingent payments might be, in substance, payments for the use of the leased property that the acquirer should recognise separately in its post-combination financial statements. In contrast, if the lease arrangement specifies lease payments that are consistent with market terms for the leased property, the arrangement for contingent payments to the selling shareholder may be contingent consideration in the acquisition.

#### Acquirer Share-Based Payment Awards Exchanged for Awards held by the Acquired Operation's Employees (see paragraph 110(b))

- AG104. An acquirer may exchange its share-based payment awards for awards held by employees of the acquired operation. The acquirer shall account for exchanges of share options or other share-based payment awards in conjunction with an acquisition in accordance with the relevant international or national accounting standard dealing with share-based payments.
- AG105. In situations in which acquired operation awards would expire as a consequence of an acquisition and if the acquirer replaces those awards when it is not obliged to do so, the acquirer shall recognise any costs as remuneration cost in the post-combination financial statements in accordance with the relevant international or national accounting standard dealing with share-based payments. The cost of those awards shall not be included in measuring the consideration transferred in the acquisition.

#### Equity-Settled Share-Based Payment Transactions of the Acquired Operation

- AG106. The acquired operation may have outstanding share-based payment transactions that the acquirer does not exchange for its share-based payment transactions. If vested, those acquired operation share-based payment transactions are part of the non-controlling interest in the acquired operation. If unvested, they are measured as if the acquisition date were the grant date. Share-based payment transactions are measured in accordance with the relevant international or national accounting standard dealing with share-based payments.

#### *Subsequent Measurement and Accounting (see paragraph 112)*

- AG107. Examples of other PBE Standards that provide guidance on subsequently measuring and accounting for assets acquired and liabilities assumed or incurred in an acquisition include:
  - (a) PBE IPSAS 31 prescribes the accounting for identifiable intangible assets acquired in an acquisition. The acquirer measures goodwill at the amount recognised at the acquisition date less any accumulated impairment losses. PBE IPSAS 26 prescribes the accounting for impairment losses.
  - (b) PBE IPSAS 35 provides guidance on accounting for changes in a controlling entity's ownership interest in a controlled entity after control is obtained.
  - (c) PBE IFRS 4 provides guidance on the subsequent accounting for an insurance contract acquired in an acquisition.

- (d) PBE IAS 12 prescribes the subsequent accounting for deferred tax assets (including unrecognised deferred tax assets) and liabilities acquired in an acquisition.

AG108. An acquirer should refer to the relevant international or national accounting standard for guidance on subsequently measuring and accounting for share-based payments.

*Subsequent Measurement of Transfers, Concessionary Loans and Similar Benefits Received by an Acquirer or Acquired Operation on the Basis of Criteria that may Change as a Result of an Acquisition (see paragraph 114)*

AG109. Prior to an acquisition taking place, an acquirer or an acquired operation may receive a transfer from a third party, based on specified criteria. For example, a national government may provide grants to those municipalities where the municipality's revenue per head of population is below a threshold. An acquisition by a municipality of a cash-generating operation may increase the revenue per head of population of the municipality so that it is above the threshold. This may cause the government to review the grant.

AG110. The acquirer shall not account for any revisions to the grant amount as part of the acquisition, but accounts for any revisions at the point the grantor makes its intentions known in accordance with other PBE Standards.

AG111. Similar circumstances may arise in respect of concessionary loans and other benefits. The acquirer shall not account for any revisions to those transactions as part of the acquisition, but accounts for any revisions at the point the grantor makes its intentions known in accordance with other PBE Standards.

*Acquisitions Occurring During a Reporting Period*

AG112. The resulting entity meets the needs of the users of its financial statements for information about the acquired operations prior to the acquisition by making the disclosures in paragraph 120(r).

AG113–AG115 [Not used]



## Appendix B

### Amendments to Other Standards

Except where otherwise stated, an entity shall apply the amendments in this Appendix when it applies PBE IPSAS 40 issued in [Date].

The amendments to other standards in this Appendix are based on the text of those other standards, including any amendments to those standards set out in:

- (a) PBE FRS 48 *Service Performance Reporting*, issued November 2017 and effective from 1 January 2021; and
- (b) NZASB ED 2018-3 *2018 Omnibus Amendments to PBE Standards*, which is expected to be issued as an amending standard in 2018 and effective from 1 January 2019.

### PBE IPSAS 4 *The Effects of Changes in Foreign Exchange Rates* (as amended by 2018 Omnibus Amendments to PBE Standards)

Paragraph 72.5 is added. New text is underlined.

**72.5 PBE IPSAS 40, issued in [date], amended paragraph A5. An entity shall apply that amendment when it applies PBE IPSAS 40.**

In Appendix A paragraph A5 is amended.<sup>14</sup> New text is underlined and deleted text is struck through.

- A5. This Appendix does not apply when an entity measures the related asset, expense or revenue on initial recognition:
- (a) At fair value; or
  - (b) At the fair value of the consideration paid or received at a date other than the date of initial recognition of the non-monetary asset or non-monetary liability arising from advance consideration (for example, the measurement of goodwill applying PBE IPSAS 40 ~~IFRS 3~~ PBE Business Combinations).

### PBE IPSAS 10 *Financial Reporting in Hyperinflationary Economies*

Paragraph 22 is amended and paragraph 39.3 is added. New text is underlined and deleted text is struck through.

22. To determine whether the restated amount of a non-monetary item has become impaired and should be reduced an entity applies relevant impairment tests in PBE IPSAS 21 *Impairment of Non-Cash-Generating Assets* or ~~and~~ PBE IPSAS 26 *Impairment of Cash-Generating Assets*. For example, restated amounts of property, plant and equipment, goodwill, patents and trademarks are reduced to recoverable amount or recoverable service amount where appropriate, and restated amounts of inventories are reduced to net realisable value or current replacement cost. An investee that is accounted for under the equity method may report in the currency of a hyperinflationary economy. The statement of financial position and statement of comprehensive revenue and expense of such an investee are restated in accordance with this Standard in order to calculate the investor's share of its net assets/equity and comprehensive revenue and expense. Where the restated financial statements of the investee are expressed in a foreign currency they are translated at closing rates.

...

**39.3 PBE IPSAS 40 *PBE Combinations* issued in [date], amended paragraph 22. An entity shall apply that amendment when it applies PBE IPSAS 40.**

<sup>14</sup> This amendment is to the text of paragraph A5 of PBE IPSAS 4, as proposed in NZASB ED 2018-3 *2018 Omnibus Amendments to PBE Standards* issued in July 2018. ED 2018-3 proposes to add Appendix A *Foreign Currency Transactions and Advance Consideration* to PBE IPSAS 4.

## PBE IPSAS 14 *Events After the Reporting Date*

Paragraph 31 is amended and paragraph 33.3 is added. New text is underlined and deleted text is struck through.

31. The following are examples of non-adjusting events after the reporting date that would generally result in disclosure:

...

- (c) A major PBE combination after the reporting date (PBE IPSAS 40 *PBE Combinations* requires specific disclosures in such cases). ~~An acquisition or disposal of a major controlled entity or the outsourcing of all or substantially all of the activities currently undertaken by an entity after the reporting date;~~

...

**33.3 PBE IPSAS 40, issued in [date], amended paragraph 31. An entity shall apply that amendment when it applies PBE IPSAS 40.**

## PBE IPSAS 16 *Investment Property*

Paragraphs 18.1, 87, 90 and the heading before paragraph 100.1 are amended and paragraphs 18A and 102.6 are added. New text is underlined and deleted text is struck through.

18A. [Not used]

18.1 Judgement is also needed to determine whether the acquisition of investment property is the acquisition of an asset or a group of assets or a PBE business combination within the scope of PBE IPSAS 40 *PBE Combinations* ~~PBE IFRS 3 *Business Combinations*~~. Reference should be made to PBE IPSAS 40 IFRS 3 to determine whether it is a PBE business combination. The discussion in paragraphs 9–18 of this Standard relates to whether or not property is owner-occupied property or investment property and not to determining whether or not the acquisition of property is a PBE business combination as defined in PBE IPSAS 40 IFRS 3. Determining whether a specific transaction meets the definition of a PBE business combination as defined in PBE IPSAS 40 IFRS 3 and includes an investment property as defined in this Standard requires the separate application of both Standards.

...

**87. In addition to the disclosures required by paragraph 86, an entity that applies the fair value model in paragraphs 42–64 shall disclose a reconciliation between the carrying amounts of investment property at the beginning and end of the period, showing the following:**

...

- (b) **Additions resulting from acquisitions through PBE entity combinations;**

...

**90. In addition to the disclosures required by paragraph 86, an entity that applies the cost model in paragraph 65 shall disclose:**

...

(d) **The reconciliation of the carrying amount of investment property at the beginning and end of the period, showing the following:**

- (i) **Additions, disclosing separately those additions resulting from acquisitions and those resulting from subsequent expenditure recognised as an asset;**

- (ii) **Additions resulting from acquisitions through PBE entity combinations;**

...

**PBE Business Combinations**

100.1 ....

...

**102.6 PBE IPSAS 40, issued in [date], amended paragraphs 18.1, 87, 90 and the heading before paragraph 100.1 and added paragraph 18A. An entity shall apply those amendments when it applies PBE IPSAS 40.**

In the Basis for Conclusions, paragraph BC8 is amended. New text is underlined and deleted text is struck through.

**2015 Omnibus Amendments to PBE Standards**

BC8. In the IASB<sup>®</sup>'s *Annual Improvements to IFRSs Cycle 2011-2013* the IASB amended IAS 40 *Investment Property* to clarify the relationship between IFRS 3 *Business Combinations* and IAS 40 when classifying property as investment property or owner-occupied property. The IPSASB did not make an equivalent amendment to IPSAS 16 in its *Improvements to IPSASs 2014* because, at that point, there was no IPSAS equivalent to IFRS 3. The NZASB noted that the IPSASB proposes to develop requirements for public sector combinations and may subsequently consider the IASB's amendment, but considered that the amendment would improve clarity and should be incorporated in PBE IPSAS 16. The NZASB therefore included an equivalent amendment in its *2015 Omnibus Amendments to PBE Standards*.<sup>1</sup>

<sup>1</sup> In January 2017 the IPSASB issued *IPSAS 40 Public Sector Combinations* and incorporated the IASB's amendment in *IPSAS 16*. In [date] the NZASB issued *PBE IPSAS 40 PBE Combinations* (which superseded PBE IFRS 3). *PBE IPSAS 16* and *IPSAS 16* are now broadly aligned in relation to this matter.

**PBE IPSAS 17 Property, Plant and Equipment**

Paragraphs 60 and 88 are amended and paragraph 108.11 is added. New text is underlined and deleted text is struck through.

60. An entity allocates the amount initially recognised in respect of an item of property, plant and equipment to its significant parts and depreciates separately each such part. For example, in most cases, it would be required to depreciate separately the pavements, formation, kerbs and channels, footpaths, bridges, and lighting within a road system. Similarly, it may be appropriate to depreciate separately the airframe and engines of an aircraft, whether owned or subject to a finance lease. If an entity acquires property, plant and equipment subject to an operating lease in which it is the lessor, it may also be appropriate to depreciate separately amounts reflected in the cost of that item that are attributable to favourable or unfavourable lease terms relative to market terms.

...

88. The financial statements shall disclose, for each class of property, plant and equipment recognised in the financial statements:

...

- (e) A reconciliation of the carrying amount at the beginning and end of the period showing:
- (i) Additions;
  - (ii) Disposals;
  - (iii) Acquisitions through PBE entity combinations;

...

**108.11 PBE IPSAS 40 PBE Combinations, issued in [date], amended paragraphs 60 and 88. An entity shall apply those amendments when it applies PBE IPSAS 40.**

## PBE IPSAS 19 Provisions, Contingent Liabilities and Contingent Assets

Paragraph 1 is amended and paragraphs 4A and 112.7 are added. New text is underlined and deleted text is struck through.

1. An entity that prepares and presents financial statements shall apply this Standard in accounting for provisions, contingent liabilities, and contingent assets, except:
  - ...
  - (f) Those arising in relation to income taxes or income tax equivalents; and
  - (g) Those arising from employee benefits, except employee termination benefits that arise as a result of a restructuring, as dealt with in this Standard; ~~and~~
  - (h) ~~[Deleted by NZASB] Contingent consideration of an acquirer in a business combination (see PBE IFRS 3 Business Combinations).~~
  - ...
- 4A. This Standard does not apply to the contingent consideration of an acquirer in a PBE combination which is within the scope of PBE IPSAS 40 PBE Combinations.
- ...
- 112.7 PBE IPSAS 40, issued in [date], amended paragraph 1 and added paragraph 4A. An entity shall apply those amendments when it applies PBE IPSAS 40.

## PBE IPSAS 21 Impairment of Non-Cash-Generating Assets<sup>15</sup>

Paragraph 14 is amended and paragraphs 20A and 83.7 are added. New text is underlined and deleted text is struck through.

14. **The following terms are used in this Standard with the meanings specified:**
  - ...
  - Cash-generating assets are assets held with the primary objective of generating a commercial return. For the purposes of impairment, goodwill is considered a cash-generating asset.**
  - ...
- 20A. For the purposes of impairment, goodwill is considered a cash-generating asset. Goodwill does not generate economic benefits independently of other assets, and is assessed for impairment as part of a group of assets. This Standard deals with the assessment of individual assets. Goodwill is recognised only where it gives rise to net cash inflows and it relates to the acquisition of a cash-generating operation. An entity shall not recognise goodwill related to service potential other than cash flows nor goodwill related to the acquisition of a non-cash-generating operation. The recoverable service amount used to assess impairment in this Standard includes service potential. Consequently, an entity applies PBE IPSAS 26 rather than this Standard to determine whether to impair goodwill.
- ...
- 83.7 PBE IPSAS 40 PBE Combinations, issued in [date], amended paragraph 14 and added paragraph 20A. An entity shall apply those amendments when it applies PBE IPSAS 40.

<sup>15</sup> The IPSASB's explanation for these changes is set out in IPSAS 21 *Impairment of Non-Cash-Generating Assets* paragraph BC5A.

## Comparison with IPSAS 21

New text is underlined and deleted text is struck through.

PBE IPSAS 21 *Impairment of Non-Cash-Generating Assets* is drawn from IPSAS 21 *Impairment of Non-Cash-Generating Assets*. The significant differences between PBE IPSAS 21 and IPSAS 21 are:

- (a) PBE Standards require the presentation of a statement of comprehensive revenue and expense. IPSASs require the presentation of a statement of financial performance. ~~Other than the impact of this difference, there are no significant differences between PBE IPSAS 21 and IPSAS 21.~~
- (b) PBE IPSAS 21 does not contain the requirements for the recognition of goodwill related to the acquisition of a non-cash-generating operation.

## PBE IPSAS 23 Revenue from Non-Exchange Transactions

Paragraphs 1 and 2 are amended and paragraph 125.5 is added. New text is underlined and deleted text is struck through.

1. The objective of this Standard is to prescribe requirements for the financial reporting of revenue arising from non-exchange transactions, other than non-exchange transactions that give rise to an PBE entity combination. This Standard deals with issues that need to be considered in recognising and measuring revenue from non-exchange transactions, including the identification of contributions from owners.
2. **An entity that prepares and presents financial statements under the accrual basis of accounting shall apply this Standard in accounting for revenue from non-exchange transactions. This Standard does not apply to an PBE entity combination that is a non-exchange transaction.**

...

125.5 PBE IPSAS 40 PBE Combinations, issued in [date], amended paragraphs 1 and 2. An entity shall apply those amendments when it applies PBE IPSAS 40.

## PBE IPSAS 26 Impairment of Cash-Generating Assets<sup>16</sup>

Paragraphs 90.1–90.15 are renumbered as paragraphs 90A–90O.

Paragraphs 111.1–111.2 are renumbered as paragraphs 111A–111B.

Paragraph 122.1 is renumbered as paragraph 122A.

Paragraphs 21, 26, 28, 37, 71 and its related heading, 76, 88, 90A, 90B, 90C, 90E, 90F, 90I, 90J, 90K, 90L, 91, 92, 97B, 97H, 98, 103, 120, 122A and 123–125 are amended.

Paragraph 123(a.1) is moved to paragraph 123(a) and the remaining subparagraphs are renumbered.

Paragraph 124(a.1) is moved to paragraph 124(a) and the remaining subparagraphs are renumbered.

Paragraphs AG22–AG29 and their related headings are moved to follow paragraph 97 and renumbered as paragraphs 97A–97H.

Paragraphs 18A, 20A, 23, 90A.1, 97B.1 and 127.8 are added.

Paragraphs 2(i), 7, 23.1, 91.1 and 96 and the examples after paragraphs 90G and 90H are deleted.

New text is underlined and deleted text is struck through.

2. **An entity that prepares and presents financial statements shall apply this Standard in accounting for the impairment of cash-generating assets, except for:**

...

- (i) ~~{Not used}~~[Deleted by IPSASB];

...

<sup>16</sup> The IPSASB's explanation for these changes is set out in IPSAS 26 *Impairment of Cash-Generating Assets* paragraphs BC8A–BC8B.

7. ~~[Not used]~~[Deleted by IPSASB]

...

18A. For the purposes of impairment, goodwill is considered a cash-generating asset. Goodwill does not generate economic benefits independently of other assets, and is assessed for impairment as part of a group of assets. PBE IPSAS 21 deals with the assessment of individual assets. Goodwill is recognised only where it gives rise to net cash inflows and it relates to the acquisition of a cash-generating operation. An entity shall not recognise goodwill related to service potential other than cash flows nor goodwill related to the acquisition of a non-cash-generating operation. The recoverable service amount used to assess impairment in PBE IPSAS 21 includes service potential. Consequently, an entity applies this Standard to determine whether to impair goodwill.

...

20A. Paragraphs 21–30 specify when recoverable amount shall be determined. These requirements use the term ‘an asset’ but apply equally to an individual asset or a cash-generating unit. The remainder of this Standard is structured as follows:

(a) Paragraphs 31–70 set out the requirements for measuring recoverable amount. These requirements also use the term ‘an asset’ but apply equally to an individual asset and a cash-generating unit.

(b) Paragraphs 71–97 set out the requirements for recognising and measuring impairment losses. Recognition and measurement of impairment losses for individual assets other than goodwill are dealt with in paragraphs 71–75. Paragraphs 76–97 deal with the recognition and measurement of impairment losses for cash-generating units and goodwill.

(c) Paragraphs 98–105 set out the requirements for reversing an impairment loss recognised in prior periods for an asset or a cash-generating unit. Again, these requirements use the term ‘an asset’ but apply equally to an individual asset or a cash-generating unit. Additional requirements for an individual asset are set out in paragraphs 106–109, for a cash-generating unit in paragraphs 110–111, and for goodwill in paragraphs 111A and 111B.

(d) Paragraphs 112–113 set out the requirements for the redesignation of an asset from a cash-generating asset to a non-cash-generating asset or from a non-cash-generating asset to a cash-generating asset.

(e) Paragraphs 114–122A specify the information to be disclosed about impairment losses and reversals of impairment losses for assets and cash-generating units. Paragraphs 123–125 specify additional disclosure requirements for cash-generating units to which goodwill or intangible assets with indefinite useful lives have been allocated for impairment testing purposes.

21. An asset is impaired when its carrying amount exceeds its recoverable amount. Paragraphs 25–27 describe some indications that an impairment loss may have occurred. If any of those indications is present, an entity is required to make a formal estimate of recoverable amount. Except for the circumstances described in paragraph 23~~–4~~, this Standard does not require an entity to make a formal estimate of recoverable amount if no indication of an impairment loss is present.

23. ~~[Not used]~~**Irrespective of whether there is any indication of impairment, an entity shall also:**

(a) Test an intangible asset with an indefinite useful life or an intangible asset not yet available for use for impairment annually by comparing its carrying amount with its recoverable amount. This impairment test may be performed at any time during an annual period, provided it is performed at the same time every year. Different intangible assets may be tested for impairment at different times. However, if such an intangible asset was initially recognised during the current annual period, that intangible asset shall be tested for impairment before the end of the current annual period.

(b) Test goodwill received or acquired in a PBE combination for impairment annually in accordance with paragraphs 90A–90O.

23.1 ~~[Deleted by NZASB]~~**Irrespective of whether there is any indication of impairment, an entity shall also:**

~~(a) Test an intangible asset with an indefinite useful life or an intangible asset not yet available for use for impairment annually by comparing its carrying amount with its recoverable amount. This impairment test may be performed at any time during an annual period, provided it is performed at the same time every year. Different intangible assets may be tested for impairment at different times. However, if such an intangible asset was initially recognised during the current annual period, that intangible asset shall be tested for impairment before the end of the current annual period.~~

~~(b) Test goodwill acquired in a business combination for impairment annually in accordance with paragraphs 90.1–90.15.~~

...

26. The list in paragraph 25 is not exhaustive. An entity may identify other indications that an asset may be impaired, and these would also require the entity to determine the asset's recoverable amount or, in the case of goodwill, perform an impairment test in accordance with paragraphs 90K.4–90Q.15.

...

28. As indicated in paragraph 23.4, this Standard requires an intangible asset with an indefinite useful life or an intangible asset that is not yet available for use and goodwill to be tested for impairment, at least annually. Apart from when the requirements in paragraph 23.4 apply, the concept of materiality applies in identifying whether the recoverable amount of an asset needs to be estimated. For example, if previous calculations show that an asset's recoverable amount is significantly greater than its carrying amount, the entity need not re-estimate the asset's recoverable amount if no events have occurred that would eliminate that difference. Similarly, previous analysis may show that an asset's recoverable amount is not sensitive to one (or more) of the indications listed in paragraph 25.

...

37. Paragraph 23.4 requires an intangible asset with an indefinite useful life to be tested for impairment annually by comparing its carrying amount with its recoverable amount, irrespective of whether there is any indication that it may be impaired. However, the most recent detailed calculation of such an asset's recoverable amount made in a preceding period may be used in the impairment test for that asset in the current period, provided all of the following criteria are met:

...

### **Recognising and Measuring an Impairment Loss of an Individual Asset**

71. Paragraphs 72–75 set out the requirements for recognising and measuring impairment losses for an individual asset other than goodwill. The recognition and measurement of impairment losses for cash-generating units and goodwill are dealt with in paragraphs 76–97H.

...

76. Paragraphs 77–97H set out the requirements for identifying the cash-generating unit to which an asset belongs and determining the carrying amount of, and recognising impairment losses for, cash-generating units and goodwill.

...

88. When assets are grouped for recoverability assessments, it is important to include in the cash-generating unit all assets that generate, or are used to generate, the relevant stream of cash inflows. Otherwise, the cash-generating unit may appear to be fully recoverable when in fact an impairment loss has occurred. The Illustrated Decision Tree provides a flow diagram illustrating the treatment of individual assets that are part of cash-generating units. In some cases, although some assets contribute to the estimated future cash flows of a cash-generating unit, they cannot be allocated to the cash-generating unit on a reasonable and consistent basis. This might be the case for goodwill. Paragraphs 90A.4–90Q.15 explain how to deal with these assets in testing a cash-generating unit for impairment.

...

**90A.4 For the purpose of impairment testing, goodwill acquired in an acquisition business combination shall, from the acquisition date, be allocated to each of the acquirer's cash-generating units, or**

groups of cash-generating units, that are expected to benefit from the synergies of the combination, irrespective of whether other assets or liabilities of the acquired operation ~~acquiree~~ are assigned to those units or groups of units. Each unit or group of units to which the goodwill is so allocated shall:

(a) Represent the lowest level within the entity at which the goodwill is monitored for internal management purposes.

(b) [Not used]

**90A.1 For the purpose of impairment testing, goodwill previously recognised by one of the combining operations in an amalgamation shall be allocated to each of the resulting entity's cash-generating units, or group of cash-generating units, within which those combining operations are integrated. If the resulting entity reorganises the combining operations containing the previously recognised goodwill, as part of integrating the combining operations into the resulting entity either during or shortly after the amalgamation, the entity shall refer to paragraph 90H for guidance.**

**90B.2** Goodwill recognised in an acquisition ~~business combination~~ is an asset representing the future economic benefits arising from other assets acquired in an acquisition ~~business combination~~ that are not individually identified and separately recognised. Goodwill does not generate cash flows independently of other assets or groups of assets, and often contributes to the cash flows of multiple cash-generating units. Goodwill sometimes cannot be allocated on a non-arbitrary basis to individual cash-generating units, but only to groups of cash-generating units. As a result, the lowest level within the entity at which the goodwill is monitored for internal management purposes sometimes comprises a number of cash-generating units to which the goodwill relates, but to which it cannot be allocated. References in paragraphs 90D.4–90Q.15 and 97A–97H ~~the Application Guidance~~ to a cash-generating unit to which goodwill is allocated should be read as references also to a group of cash-generating units to which goodwill is allocated.

**90C.3** Applying the requirements in paragraphs 90A.4 and 90A.1 results in goodwill being tested for impairment at a level that reflects the way an entity manages its operations and with which the goodwill would naturally be associated. Therefore, the development of additional reporting systems is typically not necessary.

**90D.4** ...

**90E.5** **If the initial allocation of goodwill acquired in an acquisition ~~business combination~~ cannot be completed before the end of the annual period in which the acquisition ~~business combination~~ is effected, that initial allocation shall be completed before the end of the first annual period beginning after the acquisition date.**

**90E.6** In accordance with PBE IPSAS 40 ~~IFRS 3~~ PBE Business Combinations, if the initial accounting for an acquisition ~~business combination~~ can be determined only provisionally by the end of the period in which the combination is effected, the acquirer:

- (a) Accounts for the acquisition ~~combination~~ using those provisional values; and
- (b) Recognises any adjustments to those provisional values as a result of completing the initial accounting within the measurement period, which shall not exceed twelve months from the acquisition date.

In such circumstances, it might also not be possible to complete the initial allocation of the goodwill recognised in the acquisition ~~combination~~ before the end of the annual period in which the combination is effected. When this is the case, the entity discloses the information required by paragraph 122A.4.

**90G.7** ...

<b>Example</b>
<p>An entity sells for CU100 an operation that was part of a cash-generating unit to which goodwill has been allocated. The goodwill allocated to the unit cannot be identified or associated with an asset group at a level lower than that unit, except arbitrarily. The recoverable amount of the portion of the cash-generating unit retained is CU300.</p> <p>Because the goodwill allocated to the cash-generating unit cannot be non-arbitrarily identified or associated with an asset group at a level lower than that unit, the goodwill associated with the operation disposed of is measured on the basis of the relative values of the operation disposed of</p>



and the portion of the unit retained. Therefore, 25 per cent of the goodwill allocated to the cash-generating unit is included in the carrying amount of the operation that is sold.

90H.8 ...

**Example**

Goodwill had previously been allocated to cash-generating unit A. The goodwill allocated to A cannot be identified or associated with an asset group at a level lower than A, except arbitrarily. A is to be divided and integrated into three other cash-generating units, B, C and D.

Because the goodwill allocated to A cannot be non-arbitrarily identified or associated with an asset group at a level lower than A, it is reallocated to units B, C and D on the basis of the relative values of the three portions of A before those portions are integrated with B, C and D.

*Testing Cash-Generating Units with Goodwill for Impairment*

90I.9 **When, as described in paragraph 90B.2, goodwill relates to a cash-generating unit but has not been allocated to that unit, the unit shall be tested for impairment, whenever there is an indication that the unit may be impaired, by comparing the unit's carrying amount, excluding any goodwill, with its recoverable amount. Any impairment loss shall be recognised in accordance with paragraph 91A.**

90J.10 If a cash-generating unit described in paragraph 90I.9 includes in its carrying amount an intangible asset that has an indefinite useful life or is not yet available for use and that asset can be tested for impairment only as part of the cash-generating unit, paragraph 23A requires the unit also to be tested for impairment annually.

90K.11 **A cash-generating unit to which goodwill has been allocated shall be tested for impairment annually, and whenever there is an indication that the unit may be impaired, by comparing the carrying amount of the unit, including the goodwill, with the recoverable amount of the unit. If the recoverable amount of the unit exceeds the carrying amount of the unit, the unit and the goodwill allocated to that unit shall be regarded as not impaired. If the carrying amount of the unit exceeds the recoverable amount of the unit, the entity shall recognise the impairment loss in accordance with paragraph 91A.**

90L.12 **The annual impairment test for a cash-generating unit to which goodwill has been allocated may be performed at any time during an annual period, provided the test is performed at the same time every year. Different cash-generating units may be tested for impairment at different times. However, if some or all of the goodwill allocated to a cash-generating unit was acquired in an acquisition business combination during the current annual period, that unit shall be tested for impairment before the end of the current annual period.**

90M.13 ...

90N.14 ...

90Q.15 ...

91. ~~[Not used]~~ **An impairment loss shall be recognised for a cash-generating unit (the smallest group of cash-generating units to which goodwill has been allocated) if, and only if, the recoverable amount of the unit (group of units) is less than the carrying amount of the unit (group of units). The impairment loss shall be allocated to reduce the carrying amount of the assets of the unit (group of units) in the following order:**

**(a) First, to reduce the carrying amount of any goodwill allocated to the cash-generating unit (group of units); and**

**(b) Then, to the other assets of the unit (group of units) pro rata on the basis of the carrying amount of each asset in the unit (group of units).**

**These reductions in carrying amounts shall be treated as impairment losses on individual assets and recognised in accordance with paragraph 73.**

91.1 ~~[Deleted by NZASB]~~ **An impairment loss shall be recognised for a cash-generating unit (the smallest group of cash-generating units to which goodwill has been allocated) if, and only if, the recoverable**

~~amount of the unit (group of units) is less than the carrying amount of the unit (group of units). The impairment loss shall be allocated to reduce the carrying amount of the assets of the unit (group of units) in the following order:~~

- ~~(a) First, to reduce the carrying amount of any goodwill allocated to the cash-generating unit (group of units); and~~
- ~~(b) Then, to the other assets of the unit (group of units) pro rata on the basis of the carrying amount of each asset in the unit (group of units).~~

92. In allocating an impairment loss in accordance with paragraph 91.1, an entity shall not reduce the carrying amount of an asset below the highest of:

- (a) Its fair value less costs to sell (if determinable);
- (b) Its value in use (if determinable); and
- (c) Zero.

The amount of the impairment loss that would otherwise have been allocated to the asset shall be allocated pro rata to the other cash-generating assets of the unit (group of units).

96. ~~[Deleted by IPSASB] [Not used]~~

### Impairment Testing Cash-Generating Units with Goodwill and Non-Controlling Interests

~~97AAG22.~~ In accordance with PBE IPSAS 40 IFRS 3, the acquirer measures and recognises goodwill as of the acquisition date as the excess of (a) over (b) below:

- (a) The aggregate of:
  - (i) The consideration transferred measured in accordance with PBE IPSAS 40 IFRS 3, which generally requires acquisition-date fair value;
  - (ii) The amount of any non-controlling interest in the acquired operation acquiree measured in accordance with PBE IPSAS 40 IFRS 3; and
  - (iii) In an acquisition achieved in stages, the acquisition-date fair value of the acquirer's previously held equity interest in the acquired operation acquiree.
- (b) The net of the acquisition-date amounts of the identifiable assets acquired and liabilities assumed measured in accordance with PBE IPSAS 40 IFRS 3.

#### *Allocation of Goodwill*

~~97BAG23.~~ Paragraph 90A.1 of this Standard requires goodwill acquired in an acquisition business combination to be allocated to each of the acquirer's cash-generating units, or groups of cash-generating units, expected to benefit from the synergies of the combination, irrespective of whether other assets or liabilities of the acquired operation acquiree are assigned to those units, or groups of units. It is possible that some of the synergies resulting from an acquisition business combination will be allocated to a cash-generating unit in which the non-controlling interest does not have an interest.

97B.1 Paragraph 90A.1 of this Standard requires goodwill previously recognised by one of the combining operations in an amalgamation to be allocated to each of the resulting entity's cash-generating units, or group of cash-generating units, within which those combining operations are integrated. It is possible that the goodwill will be allocated to a cash-generating unit in which the non-controlling interest does not have an interest.

#### *Testing for Impairment*

97CAG24. Testing for impairment involves comparing the recoverable amount of a cash-generating unit with the carrying amount of the cash-generating unit.

97DAG25. If an entity measures non-controlling interests as its proportionate interest in the net identifiable assets of a controlled entity at the acquisition date, rather than at fair value, goodwill attributable to non-controlling interests is included in the recoverable amount of the related cash-generating unit but is not recognised in the controlling entity's consolidated financial statements. As a consequence, an entity shall gross up the carrying amount of goodwill allocated to the unit to include the goodwill attributable to the

non-controlling interest. This adjusted carrying amount is then compared with the recoverable amount of the unit to determine whether the cash-generating unit is impaired.

#### *Allocating an Impairment Loss*

97EAG26. Paragraph 91~~4~~ requires any identified impairment loss to be allocated first to reduce the carrying amount of goodwill allocated to the unit and then to the other assets of the unit pro rata on the basis of the carrying amount of each asset in the unit.

97FAG27. If a controlled entity, or part of a controlled entity, with a non-controlling interest is itself a cash-generating unit, the impairment loss is allocated between the controlling entity and the non-controlling interest on the same basis as that on which surplus or deficit is allocated.

97GAG28. If a controlled entity, or part of a controlled entity, with a non-controlling interest is part of a larger cash-generating unit, goodwill impairment losses are allocated to the parts of the cash-generating unit that have a non-controlling interest and the parts that do not. The impairment losses should be allocated to the parts of the cash-generating unit on the basis of:

- (a) To the extent that the impairment relates to goodwill in the cash-generating unit, the relative carrying values of the goodwill of the parts before the impairment; and
- (b) To the extent that the impairment relates to identifiable assets in the cash-generating unit, the relative carrying values of the net identifiable assets of the parts before the impairment. Any such impairment is allocated to the assets of the parts of each unit pro rata on the basis of the carrying amount of each asset in the part.

In those parts that have a non-controlling interest, the impairment loss is allocated between the controlling entity and the non-controlling interest on the same basis as that on which surplus or deficit is allocated.

97HAG29. If an impairment loss attributable to a non-controlling interest relates to goodwill that is not recognised in the controlling entity's consolidated financial statements (see paragraph 97DAG25), that impairment is not recognised as a goodwill impairment loss. In such cases, only the impairment loss relating to the goodwill that is allocated to the controlling entity is recognised as a goodwill impairment loss.

### **Reversing an Impairment Loss**

98. Paragraphs 99–105 set out the requirements for reversing an impairment loss recognised for an asset or a cash-generating unit in prior periods. These requirements use the term “an asset,” but apply equally to an individual asset or a cash-generating unit. Additional requirements for an individual asset are set out in paragraphs 106–109, for a cash-generating unit in paragraphs 110 and 111, and for goodwill in paragraphs 111~~A.4~~ and 111~~B.2~~.

...

103. **An impairment loss recognised in prior periods for an asset other than goodwill shall be reversed if, and only if, there has been a change in the estimates used to determine the asset's recoverable amount since the last impairment loss was recognised. If this is the case, the carrying amount of the asset shall, except as described in paragraph 106, be increased to its recoverable amount. That increase is a reversal of an impairment loss.**

...

#### **Reversing an Impairment Loss for Goodwill**

111~~A.4~~ ...

111~~B.2~~ ...

...

\*120. **An entity shall disclose the following for each material impairment loss recognised or reversed during the period for a cash-generating asset, (including goodwill), or a cash-generating unit:**

...

- (e) Whether the recoverable amount of the asset (cash-generating unit) is its fair value less costs to sell or its value in use;

...

122A.4 If, in accordance with paragraph 90E.5, any portion of the goodwill acquired in an acquisition business combination during the period has not been allocated to a cash-generating unit (group of units) at the end of the reporting period date, the amount of the unallocated goodwill shall be disclosed together with the reasons why that amount remains unallocated.

- \*123. An entity shall disclose the information required by (a)–~~(e)~~(f) for each cash-generating unit (group of units) for which the carrying amount of goodwill or intangible assets with indefinite useful lives allocated to that unit (group of units) is significant in comparison with the entity's total carrying amount of goodwill or intangible assets with indefinite useful lives:

(a) The carrying amount of goodwill allocated to the unit (group of units);

~~(a)~~(b) The carrying amount of intangible assets with indefinite useful lives allocated to the unit (group of units);

~~(a.1)~~ ~~The carrying amount of goodwill allocated to the unit (group of units);~~

~~(b)~~(c) The basis on which the unit's (group of units') recoverable amount has been determined (i.e., value in use or fair value less costs to sell);

~~(c)~~(d) If the unit's (group of units') recoverable amount is based on value in use:

...

~~(d)~~(e) If the unit's (group of units') recoverable amount is based on fair value less costs to sell, the methodology used to determine fair value less costs to sell. If fair value less costs to sell is not determined using an observable market price for the unit, the following information shall also be disclosed:

...

~~(e)~~(f) If a reasonably possible change in a key assumption on which management has based its determination of the unit's (group of units') recoverable amount would cause the unit's carrying amount to exceed its recoverable amount:

...

- \*124. If some or all of the carrying amount of goodwill or intangible assets with indefinite useful lives is allocated across multiple cash-generating units (groups of units), and the amount so allocated to each unit (group of units) is not significant in comparison with the entity's total carrying amount of goodwill or intangible assets with indefinite useful lives, that fact shall be disclosed, together with the aggregate carrying amount of goodwill or intangible assets with indefinite useful lives allocated to those units (groups of units). In addition, if the recoverable amounts of any of those units (groups of units) are based on the same key assumption(s), and the aggregate carrying amount of goodwill or intangible assets with indefinite useful lives allocated to them is significant in comparison with the entity's total carrying amount of goodwill or intangible assets with indefinite useful lives, an entity shall disclose that fact, together with:

(a) The aggregate carrying amount of goodwill allocated to those units (groups of units);

~~(a)~~(b) The aggregate carrying amount of intangible assets with indefinite useful lives allocated to those units (groups of units);

~~(a.1)~~ ~~The aggregate carrying amount of goodwill allocated to those units (groups of units);~~

~~(b)~~(c) A description of the key assumption(s);

~~(c)~~(d) A description of management's approach to determining the value(s) assigned to the key assumption(s), whether those value(s) reflect past experience or, if appropriate, are consistent with external sources of information, and if not, how and why they differ from past experience or external sources of information;

~~(d)~~(e) **If a reasonably possible change in the key assumption(s) would cause the aggregate of the units' (groups of units)' carrying amounts to exceed the aggregate of their recoverable amounts:**

...

125. The most recent detailed calculation made in a preceding period of the recoverable amount of a cash-generating unit (group of units) may, in accordance with paragraph 37 ~~or 90O~~, be carried forward and used in the impairment test for that unit (group of units) in the current period, provided specified criteria are met. When this is the case, the information for that unit (group of units) that is incorporated into the disclosures required by paragraphs 123 and 124 relate to the carried forward calculation of recoverable amount.

...

**127.8 PBE IPSAS 40, issued in [date], renumbered paragraphs 90.1–90.15 as 90A–90O and paragraphs 111.1–111.2 as 111A–111B and paragraph 122.1 as 122A, amended paragraphs 21, 26, 28, 37, 71 and its related heading, 76, 88, 90A, 90B, 90C, 90E, 90F, 90I, 90J, 90K, 90L, 91, 92, 97B, 97H, 98, 103, 120, 122A and 123–125, moved paragraph 123(a.1) to paragraph 123(a) and paragraph 124(a.1) to paragraph 124(a) and renumbered the remaining subparagraphs, moved paragraphs AG22–AG29 and their related headings after paragraph 97 and renumbered as paragraphs 97A–97H, added paragraphs 18A, 20A, 23, 90A.1 and 97B.1 and deleted paragraphs 2(i), 7, 23.1, 91.1 and 96 and the examples after paragraphs 90G and 90H. An entity shall apply those amendments when it applies PBE IPSAS 40.**

In the Application Guidance, paragraphs AG22–AG29 and their related headings are moved into the body of the Standard (as paragraphs 97A–97H). New text is underlined.

AG22–AG29 [Moved into the body of the Standard as paragraphs 97A–97H]

### **Impairment Testing Cash-Generating Units with Goodwill and Non-Controlling Interests**

~~AG22. In accordance with PBE IFRS 3, the acquirer measures and recognises goodwill as of the acquisition date as the excess of (a) over (b) below:~~

- ~~(a) — The aggregate of:
 
  - ~~(i) — The consideration transferred measured in accordance with PBE IFRS 3, which generally requires acquisition-date fair value;~~
  - ~~(ii) — The amount of any non-controlling interest in the acquiree measured in accordance with PBE IFRS 3; and~~
  - ~~(iii) — In a business combination achieved in stages, the acquisition-date fair value of the acquirer's previously held equity interest in the acquiree.~~~~
- ~~(b) — The net of the acquisition-date amounts of the identifiable assets acquired and liabilities assumed measured in accordance with PBE IFRS 3.~~

#### *Allocation of Goodwill*

~~AG23 Paragraph 90.1 of this Standard requires goodwill acquired in a business combination to be allocated to each of the acquirer's cash-generating units, or groups of cash-generating units, expected to benefit from the synergies of the combination, irrespective of whether other assets or liabilities of the acquiree are assigned to those units, or groups of units. It is possible that some of the synergies resulting from a business combination will be allocated to a cash-generating unit in which the non-controlling interest does not have an interest.~~

#### *Testing for Impairment*

~~AG24 Testing for impairment involves comparing the recoverable amount of a cash-generating unit with the carrying amount of the cash-generating unit.~~

~~AG25 If an entity measures non-controlling interests as its proportionate interest in the net identifiable assets of a controlled entity at the acquisition date, rather than at fair value, goodwill attributable to non-controlling interests is included in the recoverable amount of the related cash-generating unit but is not recognised in the controlling entity's consolidated financial statements. As a consequence, an entity shall gross up the carrying amount of goodwill allocated to the unit to include the goodwill attributable to the non-controlling interest. This adjusted carrying amount is then compared with the recoverable amount of the unit to determine whether the cash-generating unit is impaired.~~

#### *Allocating an Impairment Loss*

~~AG26 Paragraph 91.1 requires any identified impairment loss to be allocated first to reduce the carrying amount of goodwill allocated to the unit and then to the other assets of the unit pro-rata on the basis of the carrying amount of each asset in the unit.~~

~~AG27 If a controlled entity, or part of a controlled entity, with a non-controlling interest is itself a cash-generating unit, the impairment loss is allocated between the controlling entity and the non-controlling interest on the same basis as that on which surplus or deficit is allocated.~~

~~AG28 If a controlled entity, or part of a controlled entity, with a non-controlling interest is part of a larger cash-generating unit, goodwill impairment losses are allocated to the parts of the cash-generating unit that have a non-controlling interest and the parts that do not. The impairment losses should be allocated to the parts of the cash-generating unit on the basis of:~~

- ~~(a) To the extent that the impairment relates to goodwill in the cash-generating unit, the relative carrying values of the goodwill of the parts before the impairment; and~~
- ~~(b) To the extent that the impairment relates to identifiable assets in the cash-generating unit, the relative carrying values of the net identifiable assets of the parts before the impairment. Any such impairment is allocated to the assets of the parts of each unit pro-rata on the basis of the carrying amount of each asset in the part.~~

~~In those parts that have a non-controlling interest, the impairment loss is allocated between the controlling entity and the non-controlling interest on the same basis as that on which surplus or deficit is allocated.~~

~~AG29 If an impairment loss attributable to a non-controlling interest relates to goodwill that is not recognised in the controlling entity's consolidated financial statements (see paragraph AG25), that impairment is not recognised as a goodwill impairment loss. In such cases, only the impairment loss relating to the goodwill that is allocated to the controlling entity is recognised as a goodwill impairment loss.~~

In the Basis for Conclusions, paragraphs BC7.1 – BC7.5 are added. Paragraph BC7 is deleted. New text is underlined and deleted text is struck through. Paragraph BC6 has not been amended but has been included for context when reading paragraph BC7.1.

#### **Goodwill**

BC6. As a consequence of including PBE IFRS 3 *Business Combinations* in the PBE Standards, requirements and guidance regarding the allocation of goodwill to cash-generating units, testing cash-generating assets with goodwill for impairment and reversing an impairment loss for goodwill have been included in PBE IPSAS 26. This additional material is identical to the requirements and guidance in NZ IAS 36 *Impairment of Assets*.

BC7. [Deleted by NZASB] ~~An illustrative example of impairment testing cash-generating units with goodwill is available in the additional material for NZ IAS 36 on the XRB website at [www.xrb.govt.nz](http://www.xrb.govt.nz).~~

BC7.1 The IPSASB issued IPSAS 40 *Public Sector Combinations* in January 2017 and incorporated the guidance on (a) the impairment of goodwill, (b) the allocation of goodwill to cash-generating units, and (c) testing cash-generating units with goodwill for impairment from IAS 36 *Impairment of Assets* in IPSAS 26. The NZASB incorporated this guidance in PBE IPSAS 26 when it bought PBE IFRS 3 into the suite of PBE Standards. The NZASB issued PBE IPSAS 40 *PBE Combinations* (which superseded PBE IFRS 3) based on IPSAS 40. PBE IPSAS 26 and IPSAS 26 are now broadly aligned in relation to this matter.

BC7.2 IPSAS 26 does not contain requirements for the accounting for goodwill previously recognised by one of the combining operations in an amalgamation. The NZASB thought it would be helpful to add requirements on how goodwill is allocated and tested for impairment in this situation (see paragraphs 90A.1 and 97B.1).

### **Acquiring a Non-Cash-Generating Operation**

BC7.3 IPSAS 40 amended IPSAS 26 to include requirements on impairment testing for goodwill acquired in an acquisition of a non-cash-generating operation. The amendments to IPSAS 26 required that, where goodwill is acquired in an acquisition of a non-cash-generating operation that results in a reduction in the net cash outflows of the acquirer, the acquirer (i.e. the entire reporting entity) is treated as a cash-generating unit for the purposes of impairment testing of goodwill. Paragraphs 90A and 90B of IPSAS 26 read as follows (emphasis added).

90A. For the purpose of impairment testing, goodwill acquired in an acquisition shall, from the acquisition date, be allocated to each of the acquirer's cash-generating units, or groups of cash-generating units, that is expected to benefit from the synergies of the combination, irrespective of whether other assets or liabilities of the acquired operation are assigned to those units or groups of units. **Where goodwill is acquired in an acquisition of a non-cash-generating operation that results in a reduction in the net cash outflows of the acquirer, the acquirer shall be considered as the cash-generating unit. Except where goodwill relates to the acquisition of a non-cash-generating operation,** each unit or group of units to which the goodwill is so allocated shall:

- (a) Represent the lowest level within the entity at which the goodwill is monitored for internal management purposes; and
- (b) Not be larger than a segment as defined by paragraph 9 of IPSAS 18, *Segment Reporting*.

90B. Goodwill recognized in an acquisition is an asset representing the future economic benefits arising from other assets acquired in an acquisition that are not individually identified and separately recognized. Goodwill does not generate cash flows, or reductions in net cash outflows, independently of other assets or groups of assets, and often contributes to the cash flows of multiple cash-generating units. Goodwill sometimes cannot be allocated on a non-arbitrary basis to individual cash-generating units, but only to groups of cash-generating units. As a result, the lowest level within the entity at which the goodwill is monitored for internal management purposes sometimes comprises a number of cash-generating units to which the goodwill relates, but to which it cannot be allocated. References in paragraphs 90D–90O and 97A–97H to a cash-generating unit to which goodwill is allocated should be read as references also to a group of cash-generating units to which goodwill is allocated. **Where goodwill is acquired in an acquisition of a non-cash-generating operation that results in a reduction in the net cash outflows of the acquirer, references in paragraphs 90D–90O and 97A–97H to a cash-generating unit to which goodwill is allocated should be read as references also to the acquirer.**

BC7.4 The NZASB was of the view that, although goodwill could arise in an acquisition of a non-cash-generating operation, it is not appropriate to treat the acquirer as a cash-generating unit. This is because of concerns about the practical workability of the requirements for impairment testing the goodwill in accordance with IPSAS 26 when applied to the entire entity.

BC7.5 To address these concerns, the NZASB considered that a practical solution would be to require that goodwill arising on the acquisition of a non-cash-generating operation be expensed in surplus or deficit at the acquisition date. The NZASB therefore omitted the IPSASB's requirements in relation to goodwill arising from a non-cash-generating operation (from paragraphs 90A and 90B of PBE IPSAS 26), and amended paragraphs 86 and AG93 of PBE IPSAS 40 to require the recognition of the resulting loss in surplus or deficit if goodwill arises from the acquisition of a non-cash-generating operation. These changes led to further changes in paragraph 20A of PBE IPSAS 21 *Impairment of Non-Cash-Generating Assets* and paragraph 18A of PBE IPSAS 26.

In the Implementation Guidance, paragraphs IG24A–IG24D and their related headings are added.

### **Including Goodwill in the Carrying Amount of an Operation on Disposal**

#### *Background*

IG24A. A municipality sells for CU100 an operation that was part of a cash-generating unit to which goodwill has been allocated. The goodwill allocated to the unit cannot be identified or associated with an asset group at a level lower than that unit, except arbitrarily. The recoverable amount of the portion of the cash-generating unit retained is CU300.

#### *Accounting Treatment*

IG24B. Because the goodwill allocated to the cash-generating unit cannot be non-arbitrarily identified or associated with an asset group at a level lower than that unit, the goodwill associated with the operation disposed of is measured on the basis of the relative values of the operation disposed of and the portion of the unit retained. Therefore, 25 percent of the goodwill allocated to the cash-generating unit is included in the carrying amount of the operation that is sold.

### **Reallocation of Goodwill when a Cash-Generating Unit is Restructured**

#### *Background*

IG24C. Goodwill had previously been allocated to cash-generating unit A. The goodwill allocated to A cannot be identified or associated with an asset group at a level lower than A, except arbitrarily. A is to be divided and integrated into three other cash-generating units: B, C and D.

#### *Accounting Treatment*

IG24D. Because the goodwill allocated to A cannot be non-arbitrarily identified or associated with an asset group at a level lower than A, it is reallocated to units B, C and D on the basis of the relative values of the three portions of A before those portions are integrated with B, C and D.

### **Comparison with IPSAS 26**

New text is underlined and deleted text is struck through.

PBE IPSAS 26 *Impairment of Cash-Generating Assets* is drawn from IPSAS 26 *Impairment of Cash-Generating Assets*.

The significant differences between PBE IPSAS 26 and IPSAS 26 are:

- ~~(a) PBE IPSAS 26 includes requirements and guidance regarding goodwill acquired in a business combination, the impairment of that goodwill and the reversal of any impairment loss of goodwill. PBE IPSAS 26 also requires disclosures regarding this goodwill.~~
- ~~(a)~~(b) PBE Standards require the presentation of a statement of comprehensive revenue and expense. IPSASs require the presentation of a statement of financial performance. Other than the impact of this difference, there are no significant differences between PBE IPSAS 26 and IPSAS 26.
- ~~(b)~~ PBE IPSAS 26 does not contain requirements for the accounting of goodwill related to the acquisition of a non-cash-generating operation.
- ~~(c)~~ PBE IPSAS 26 includes requirements for the accounting for goodwill previously recognised by one of the combining operations in an amalgamation.



## PBE IPSAS 27 *Agriculture*

Paragraph 48 is amended and paragraph 57.5 is added. New text is underlined and deleted text is struck through.

48. **An entity shall present a reconciliation of changes in the carrying amount of biological assets between the beginning and the end of the current period. The reconciliation shall include:**

...

- (g) **Increases resulting from PBE entity combinations;**

...

**57.5 PBE IPSAS 40 *PBE Combinations* issued in [date], amended paragraph 48. An entity shall apply that amendment when it applies PBE IPSAS 40.**

## PBE IPSAS 29 *Financial Instruments: Recognition and Measurement* (if an entity has not early adopted PBE IFRS 9)

Paragraphs 2 and 10 are amended and paragraph 126.7 is added. New text is underlined and deleted text is struck through. The lead in text for paragraph 10(aa) has not been amended but has been included for context when reading this paragraph.

2. **This Standard shall be applied by all entities to all types of financial instruments, except:**

...

- (f) **Any forward contracts between an acquirer and seller to buy or sell an acquired operation acquiree that will result in an PBE entity combination at a future acquisition date. The term of the forward contract should not exceed a reasonable period normally necessary to obtain any required approvals and to complete the transaction.**

...

10. **The following terms are used in this Standard with the meanings specified:**

### *Definitions of four categories of financial instruments*

**A financial asset or financial liability at fair value through surplus or deficit is a financial asset or financial liability that meets any of the following conditions.**

...

- (aa) **It is contingent consideration of an acquirer in a PBE business combination to which PBE IPSAS 40 IFRS 3 Business PBE Combinations applies.**

...

**126.7 PBE IPSAS 40, issued in [date], amended paragraphs 2, 10, AG35, AG131 and B4. An entity shall apply those amendments when it applies PBE IPSAS 40.**

In Appendix A, paragraphs AG35 and AG131 are amended. New text is underlined and deleted text is struck through.

- AG35. Sales before maturity could satisfy the condition in paragraph 10 – and therefore not raise a question about the entity’s intention to hold other investments to maturity – if they are attributable to any of the following:

...

- (c) A major PBE entity combination or major disposition (such as a sale of a segment) that necessitates the sale or transfer of held-to-maturity investments to maintain the entity’s existing interest rate risk position or credit risk policy (although the PBE entity combination is an event

within the entity's control, the changes to its investment portfolio to maintain an interest rate risk position or credit risk policy may be consequential rather than anticipated).

...

AG131. A firm commitment to acquire an entity or an integrated set of activities in an PBE ~~entity~~ combination cannot be a hedged item, except for foreign exchange risk, because the other risks being hedged cannot be specifically identified and measured. These other risks are general operational risks.

In Appendix B, paragraph B4 is amended. New text is underlined and deleted text is struck through.

B4. This Appendix applies to all embedded derivatives within the scope of PBE IPSAS 29 except the acquisition of contracts with embedded derivatives in an PBE ~~entity~~ combination or their possible reassessment at the date of acquisition.

In the Implementation Guidance, example F.2.3 is amended. New text is underlined and deleted text is struck through.

### F.2.3 Hedge Accounting: Core Deposit Intangibles

#### **Is hedge accounting treatment permitted for a hedge of the fair value exposure of core deposit intangibles?**

It depends on whether the core deposit intangible is generated internally or acquired (e.g., as part of an PBE ~~entity~~ combination).

...

## **PBE IPSAS 31 *Intangible Assets*<sup>17</sup>**

Paragraphs 39.1–39.5 are renumbered as paragraphs 39A–39E.

Paragraphs 39.6–39.8 are renumbered as paragraphs 39.1–39.3.

Paragraphs 6, 18, 24, 39A–39D and the related headings, 40, 41, 66, 67, 93 and 117 are amended.

Paragraphs 18A, 26A, 93A, 114A and 133.8 and a heading above paragraph 18 are added.

Paragraphs 3(e), 3(f) and 114.1 are deleted.

New text is underlined and deleted text is struck through.

### **3. This Standard shall be applied in accounting for intangible assets, except:**

...

(e) ~~[Deleted by IPSASB]–[Not used]~~

(f) ~~[Deleted by IPSASB]–Goodwill acquired in a business combination (see PBE IFRS 3 *Business Combinations*);~~

...

6. If another PBE Standard prescribes the accounting for a specific type of intangible asset, an entity applies that PBE Standard instead of this Standard. For example, this Standard does not apply to:

...

(d) Financial assets as defined in PBE IPSAS 28. The recognition and measurement of some financial assets are covered by PBE IPSAS 34 *Separate Financial Statements*, PBE IPSAS 35 *Consolidated Financial Statements* and PBE IPSAS 36 *Investments in Associates and Joint Ventures*; ~~and~~

(e) Recognition and initial measurement of service concession assets that are within the scope of PBE IPSAS 32 *Service Concession Assets: Grantor*. However, this Standard applies to the subsequent measurement and disclosure of such assets; ~~and~~ and

(f) Goodwill (see PBE IPSAS 40 *PBE Combinations*).

<sup>17</sup> The IPSASB's explanation for these changes is set out in IPSAS 31 *Intangible Assets* paragraph BC4A.

...

*Identifiability*

18. Not all the items described in paragraph 17 meet the definition of an intangible asset, i.e., identifiability, control over a resource, and existence of future economic benefits or service potential. If an item within the scope of this Standard does not meet the definition of an intangible asset, expenditure to acquire it or generate it internally is recognised as an expense when it is incurred. However, if the item is acquired in an acquisition, it forms part of the goodwill recognised at the acquisition date (see paragraph 66).

18A. The definition of an intangible asset requires an intangible asset to be identifiable to distinguish it from goodwill. Goodwill recognised in an acquisition is an asset representing the future economic benefits arising from other assets acquired in an acquisition that are not individually identified and separately recognised. The future economic benefits may result from synergy between the identifiable assets acquired or from assets that, individually, do not qualify for recognition in the financial statements.

...

24. An entity may have a portfolio of users of its services or its success rate in reaching intended users of its services and expect that, because of its efforts in building relationships with users of its services, those users will continue to use its services. However, in the absence of legal rights to protect, or other ways to control the relationships with users of a service or the loyalty of those users, the entity usually has insufficient control over the expected economic benefits or service potential from relationships with users of a service and loyalty for such items (e.g., portfolio of users of a service, market shares or success rates of a service, relationships with, and loyalty of, users of a service) to meet the definition of intangible assets. In the absence of legal rights to protect such relationships, exchange transactions for the same or similar non-contractual customer relationships (other than as part of an acquisition) provide evidence that the entity is nonetheless able to control the expected future economic benefits or service potential flowing from the relationships with the users of a service. Because such exchange transactions also provide evidence that the relationships with users of a service are separable, those relationships meet the definition of an intangible asset.

...

26A. Paragraphs 32–39 deal with the application of the recognition criteria to separately acquired intangible assets, and paragraphs 39.1–41 deal with their application to intangible assets acquired in a PBE combination. Paragraphs 42–43 deal with the initial measurement of intangible assets acquired through non-exchange transactions, paragraphs 44–45 with exchanges of intangible assets, and paragraphs 46–48 with the treatment of internally generated goodwill. Paragraphs 49–65 deal with the initial recognition and measurement of internally generated intangible assets.

...

**Acquisition of an Intangible Asset as Part of an Acquisition (PBE Business Combination)**

39A.1 In accordance with PBE ~~IPSAS 40~~ ~~IFRS 3~~, if an intangible asset is acquired in an acquisition business combination, the cost of that intangible asset is its fair value at the acquisition date. The fair value of an intangible asset will reflect expectations about the probability that the future economic benefits or service potential embodied in the asset will flow to the entity. In other words, the entity expects there to be an inflow of economic benefits or service potential, even if there is uncertainty about the timing or the amount of the inflow. Therefore, the probability recognition criterion in paragraph 28(a) is always considered to be satisfied for intangible assets acquired in acquisitions-business combinations. If an asset acquired in an acquisition business combination is separable or arises from binding arrangements (including rights from contractual or other legal rights), sufficient information exists to measure reliably the fair value of the asset. Thus, the reliable measurement criterion in paragraph 28(b) is always considered to be satisfied for intangible assets acquired in acquisitions-business combinations.

39B.2 In accordance with this Standard and PBE ~~IPSAS 40~~ ~~IFRS 3~~, an acquirer recognises at the acquisition date, separately from goodwill, an intangible asset of the acquired operation acquiree, irrespective of whether the asset had been recognised by the acquired operation acquiree before the acquisition business combination. This means that the acquirer recognises as an asset separately from goodwill an in-process research and development project of the acquired operation acquiree if the project meets the definition of

an intangible asset. An acquired operation's ~~acquiree's~~ in-process research and development project meets the definition of an intangible asset when it:

- (a) Meets the definition of an asset; and
- (b) Is identifiable, i.e., is separable or arises from binding arrangements (including rights from contracts~~ual~~ or other legal rights).

*Measuring the Fair Value of an Intangible Asset Acquired in an Acquisition (PBE-Business Combination)*

39C.3 If an intangible asset acquired in an acquisition business combination is separable or arises from binding arrangements (including rights from contracts~~ual~~ or other legal rights), sufficient information exists to measure reliably the fair value of the asset. When, for the estimates used to measure an intangible asset's fair value, there is a range of possible outcomes with different probabilities, that uncertainty enters into the measurement of the asset's fair value.

39D.4 An intangible asset acquired in an acquisition business combination might be separable, but only together with a binding arrangement related contract, identifiable asset or liability. In such cases, the acquirer recognises the intangible assets separately from goodwill but together with the related item.

39E.5 ...

39.16...

39.27 ...

39.38 Entities that are involved in the purchase and sale of intangible assets may have developed techniques for estimating their fair values indirectly. These techniques may be used for initial measurement of an intangible asset acquired in an acquisition business combination if their objective is to estimate fair value and if they reflect current transactions and practices in the industry to which the asset belongs. These techniques include, for example:

...

40. **Research or development expenditure that:**

- (a) **Relates to an in-process research or development project acquired separately or in an acquisition and recognised as an intangible asset; and**

...

41. Applying the requirements in paragraphs 52–60 means that subsequent expenditure on an in-process research or development project acquired separately or in an acquisition and recognised as an intangible asset is:

...

66. **Expenditure on an intangible item shall be recognised as an expense when it is incurred unless:**

- (a) **It forms part of the cost of an intangible asset that meets the recognition criteria (see paragraphs 26–65); or**
- (b) **The item is acquired in an acquisition business combination and cannot be recognised as an intangible asset. If this is the case, it forms part of the amount recognised as goodwill at the acquisition date (see PBE IPSAS 40 IFRS 3).**

67. In some cases, expenditure is incurred to provide future economic benefits or service potential to an entity, but no intangible asset or other asset is acquired or created that can be recognised. In the case of the supply of goods, the entity recognises such expenditure as an expense when it has a right to access those goods. In the case of the supply of services, the entity recognises the expenditure as an expense when it receives the services. For example, expenditure on research is recognised as an expense when it is incurred (see paragraph 52), ~~except when it is acquired as part of an acquisition business combination~~. Other examples of expenditure that is recognised as an expense when it is incurred include:

...

93. **The useful life of an intangible asset that arises from binding arrangements (including rights from contracts or other legal rights) shall not exceed the period of the binding arrangement (including**

rights from contracts or other legal rights), but may be shorter depending on the period over which the entity expects to use the asset. If the binding arrangements (including rights from contracts or other legal rights) are conveyed for a limited term that can be renewed, the useful life of the intangible asset shall include the renewal period(s) only if there is evidence to support renewal by the entity without significant cost. ~~The useful life of a reacquired right recognised as an intangible asset in a business combination is the remaining contractual period of the contract in which the right was granted and shall not include renewal periods.~~

**93A. The useful life of:**

**(a) A license or similar right previously granted by one combining operation to another combining operation that is recognised by the resulting entity in an amalgamation; or**

**(b) A reacquired right recognised as an intangible asset in an acquisition**

**is the remaining period of the binding arrangement (including rights from contracts or other legal rights) in which the right was granted and shall not include renewal periods.**

...

**114A. In the case of:**

**(a) A license or similar right previously granted by one combining operation to another combining operation that is recognised by the resulting entity in an amalgamation; or**

**(b) A reacquired right recognised as an intangible asset in an acquisition,**

**if the right is subsequently reissued (sold) to a third party, the related carrying amount, if any, shall be used in determining the gain or loss on reissue.**

**114.1 ~~[Deleted by NZASB] In the case of a reacquired right in a business combination, if the right is subsequently reissued (sold) to a third party, the related carrying amount, if any, shall be used in determining the gain or loss on reissue.~~**

...

**117. An entity shall disclose the following for each class of intangible assets, distinguishing between internally generated intangible assets and other intangible assets:**

...

**(e) A reconciliation of the carrying amount at the beginning and end of the period showing:**

**(i) Additions, indicating separately those from internal development, ~~and~~ those acquired separately, ~~and those acquired through acquisitions;~~**

...

**133.8 PBE IPSAS 40, issued in [date], renumbered paragraphs 39.1–39.5 as paragraphs 39A–39E and paragraphs 39.6–39.8 as paragraphs 39.1–39.3, amended paragraphs 6, 18, 24, 39A–39D and the related headings, 40, 41, 66, 67, 93 and 117, added paragraphs 18A 26A, 93A and 114A and a heading above paragraph 18, and deleted paragraphs 3(e), 3(f) and 114.1. An entity shall apply those amendments when it applies PBE IPSAS 40.**

In the Basis for Conclusions, paragraph BC6.1 is added. New text is underlined. Paragraph BC6 has not been amended but has been included for context when reading paragraph BC6.1.

### **Goodwill and Intangible Assets Acquired in a Business Combination**

BC6. NZ IAS 38 *Intangible Assets* contains requirements and guidance on intangible assets acquired in a business combination. When the IPSASB first issued IPSAS 31, which is based on IAS 38, it had not developed an IPSAS on business combinations. The IPSASB therefore excluded intangible assets acquired in a business combination from the scope of IPSAS 31. As a consequence of deciding that PBE IFRS 3 *Business Combinations* should form part of the suite of PBE Standards the NZASB agreed that PBE IPSAS 31 should include guidance on intangible assets acquired in a business combination.

BC6.1 In January 2017 the IPSASB issued IPSAS 40 *Public Sector Combinations* and incorporated guidance in IPSAS 31 on intangible assets acquired in a public sector combination. In [date] the NZASB issued PBE IPSAS 40 *PBE Combinations* and incorporated guidance in PBE IPSAS 31 on intangible assets acquired in a PBE combination. PBE IPSAS 31 and IPSAS 31 are now broadly aligned in relation to this matter.

## Comparison with IPSAS 31

Deleted text is struck through.

PBE IPSAS 31 *Intangible Assets* is drawn from IPSAS 31 *Intangible Assets*.

The significant differences between PBE IPSAS 31 and IPSAS 31 are:

- (a) PBE IPSAS 31 requires that where intangible heritage assets are able to be reliably measured they shall be recognised.
- ~~(b) PBE IPSAS 31 includes guidance on goodwill and intangible assets acquired in a business combination.~~
- ~~(b)~~(e) PBE IPSAS 31 does not require disclosure of the carrying amount that would have been recognised had a revalued class of intangible assets been measured after initial recognition using the cost model.
- ~~(c)~~(4) PBE Standards require the presentation of a statement of comprehensive revenue and expense. IPSASs require the presentation of a statement of financial performance.

## PBE IPSAS 35 *Consolidated Financial Statements*

Paragraph 4 and its related heading, paragraphs 40, 56, 57, 63 and 74 are amended and paragraphs 55A and 79.4 are added. New text is underlined and deleted text is struck through.

### PBE Business Combinations

4. This Standard does not deal with the accounting requirements for entity combinations and their effect on consolidation, including goodwill arising on an entity combination (guidance on accounting for entity combinations can be found in PBE IPSAS 40 ~~IFRS 3~~ PBE *Business Combinations*).

...

40. Consolidated financial statements:

- (a) ...
- (b) Offset (eliminate) the carrying amount of the controlling entity's investment in each controlled entity and the controlling entity's portion of net assets/equity of each controlled entity (PBE IPSAS 40 ~~IFRS 3~~ explains how to account for any related goodwill).

...

55A. [Not used]

56. **Except as described in paragraph 57, an investment entity shall not consolidate its controlled entities or apply PBE IPSAS 40 ~~IFRS 3~~ when it obtains control of another entity. Instead, an investment entity shall measure an investment in a controlled entity at fair value through surplus or deficit in accordance with PBE IPSAS 29.**

57. **Notwithstanding the requirement in paragraph 56, if an investment entity has a controlled entity that is not itself an investment entity and whose main purpose and activities are providing services that relate to the investment entity's investment activities (see paragraphs AG98–AG100), it shall consolidate that controlled entity in accordance with paragraphs 38–55 of this Standard and apply the requirements of PBE IPSAS 40 ~~IFRS 3~~ to the acquisition of any such controlled entity.**

...

63. **When an entity ceases to be an investment entity, it shall apply PBE IPSAS 40 ~~IFRS 3~~ to any controlled entity that was previously measured at fair value through surplus or deficit in accordance**

with paragraph 56. The date of the change of status shall be the deemed acquisition date. The fair value of the controlled entity at the deemed acquisition date shall represent the transferred deemed consideration when measuring any goodwill or gain from a bargain purchase that arises from the deemed acquisition. All controlled entities shall be consolidated in accordance with paragraphs 38–51 of this Standard from the date of change of status.

...

74. **If, at the date of initial application, an entity concludes that it shall consolidate another entity that was not consolidated in accordance with PBE IPSAS 6 (PS) or PBE IPSAS 6 (NFP), the entity shall:**

- (a) **If the other entity is a business (as defined in PBE IFRS 3),<sup>2</sup> measure the assets, liabilities and non-controlling interests in that previously unconsolidated entity as if that entity had been consolidated (and thus had applied acquisition accounting in accordance with PBE IFRS 3) from the date when the entity obtained control of that other entity on the basis of the requirements of this Standard. The entity shall adjust retrospectively the annual period immediately preceding the date of initial application. When the date that control was obtained is earlier than the beginning of the immediately preceding period, the entity shall recognise, as an adjustment to net assets/equity at the beginning of the immediately preceding period, any difference between:**

...

<sup>2</sup> PBE IFRS 3 remains applicable until PBE IPSAS 40 is applied or becomes effective, whichever is earlier.

**79.4 PBE IPSAS 40, issued in [date], amended paragraphs 4 and its related heading, 40, 56, 57, 63, and 74, and added paragraph 55A. An entity shall apply those amendments when it applies PBE IPSAS 40.**

In the Basis for Conclusions, paragraph BC3 is amended and paragraph BC3.1 is added. New text is underlined and deleted text is struck through.

#### **Sale or Contribution of Assets between an Investor and its Associate or Joint Venture**

BC3. PBE IPSAS 35 does not incorporate the IASB<sup>®</sup>'s narrow scope amendments in *Sale or Contribution of Assets between an Investor and its Associate or Joint Venture* (Amendments to IFRS 10 and IAS 28), which the IASB issued in September 2014 and the NZASB issued for application by for-profit entities shortly thereafter. These narrow scope amendments established requirements for the recognition of a partial gain or loss for transactions between an investor and its associate or joint venture dependent on whether the sale or contribution of assets constitutes a business as defined in IFRS 3 *Business Combinations*. The IPSASB did not incorporate these requirements in IPSAS 35 because the IPSASB, at that stage, had not developed a standard dealing with combinations of entities. Given the existence of PBE IFRS 3 *Business Combinations* within PBE Standards, the NZASB considered incorporating these amendments in PBE IPSAS 35. However, following the IASB's decision to defer the effective date of these amendments (pending further work on its equity method project) the NZASB decided not to incorporate these amendments in PBE IPSAS 35.

**BC3.1 In January 2017 the IPSASB issued IPSAS 40 *Public Sector Combinations*. IPSAS 40 incorporated *Sale or Contribution of Assets between an Investor and its Associate or Joint Venture* (Amendments to IFRS 10 and IAS 28) and *Effective Date of Amendments to IFRS 10 and IAS 28* (issued by the IASB in December 2015) in IPSAS 35. In developing PBE IPSAS 40 *PBE Combinations* the NZASB reconsidered incorporating these amendments in PBE IPSAS 35 but, given the IASB's decision in May 2016 to defer work on its Equity Method research project until it has undertaken post-implementation reviews of certain standards, decided not to incorporate these amendments in PBE IPSAS 35.**

In the Illustrative Examples, paragraph IE 13A is added. New text is underlined.

IE13A. [Not used]

## PBE IPSAS 36 *Investments in Associates and Joint Ventures*

Paragraph 26 is amended and paragraphs 34A–34B and 51.4 are added. New text is underlined and deleted text is struck through.

26. **An entity shall discontinue the use of the equity method from the date when its investment ceases to be an associate or a joint venture as follows:**

(a) **If the investment becomes a controlled entity, the entity shall account for its investment in accordance with PBE IPSAS 40 ~~IFRS 3~~ PBE Business Combinations and PBE IPSAS 35.**

...

34A–34B. [Not used]

...

**51.4 PBE IPSAS 40, issued in [date], amended paragraph 26 and added paragraphs 34A–34B. An entity shall apply that amendment when it applies PBE IPSAS 40.**

In the Basis for Conclusions, paragraph BC3 is amended and paragraph BC3.1 is added. New text is underlined and deleted text is struck through.

### Sale or Contribution of Assets between an Investor and its Associate or Joint Venture

BC3. PBE IPSAS 36 does not incorporate the IASB<sup>®</sup>'s narrow scope amendments in *Sale or Contribution of Assets between an Investor and its Associate or Joint Venture* (Amendments to IFRS 10 and IAS 28), issued in September 2014. These narrow scope amendments established requirements for the recognition of a partial gain or loss for transactions between an investor and its associate or joint venture dependent on whether the sale or contribution of assets constitutes a business as defined in IFRS 3 *Business Combinations*. The IPSASB did not incorporate these requirements in IPSAS 36 because the IPSASB, at that stage, had not developed a standard dealing with combinations of entities. Given the existence of PBE IFRS 3 *Business Combinations* within PBE Standards, the NZASB considered incorporating these amendments in PBE IPSAS 36. However, following the IASB's decision to defer the effective date of these amendments (pending further work on its equity method project) the NZASB decided not to incorporate these amendments in PBE IPSAS 36.

BC3.1 In January 2017 the IPSASB issued IPSAS 40 *Public Sector Combinations*. IPSAS 40 incorporated *Sale or Contribution of Assets between an Investor and its Associate or Joint Venture* (Amendments to IFRS 10 and IAS 28) and the IASB *Effective Date of Amendments to IFRS 10 and IAS 28* (issued by the IASB in December 2015) in IPSAS 35. In developing PBE IPSAS 40 *PBE Combinations* the NZASB reconsidered incorporating these amendments in PBE IPSAS 36 but, given the IASB's decision in May 2016 to defer work on its Equity Method research project until it has undertaken post-implementation reviews of certain standards, decided not to incorporate these amendments in PBE IPSAS 36.

## PBE IPSAS 37 *Joint Arrangements*

Paragraph 24.1 is amended and paragraphs 41A and 42.4 are added. New text is underlined and deleted text is struck through.

24.1 When an entity acquires an interest in a joint operation in which the activity of the joint operation constitutes an operation business, as defined in PBE IPSAS 40 ~~IFRS 3~~ PBE Business Combinations, it shall apply, to the extent of its share in accordance with paragraph 23, all of the principles on acquisition business combinations accounting in PBE IPSAS 40 ~~IFRS 3~~, and other PBE Standards, that do not conflict with the guidance in this Standard and disclose the information that is required in those PBE Standards in relation to acquisitions business combinations. This applies to the acquisition of both the initial interest and additional interests in a joint operation in which the activity of the joint operation constitutes an operation business. The accounting for the acquisition of an interest in such a joint operation is specified in paragraphs AG33.1–AG33.4.



41A. [Not used]

**42.4 PBE IPSAS 40, issued in [date], amended paragraphs 24.1 and AG33.1–AG33.3A and added paragraph 41A. An entity shall apply those amendments when it applies PBE IPSAS 40.**

In Appendix A, paragraphs AG33.1–AG33.3A are amended.<sup>18</sup> New text is underlined and deleted text is struck through.

AG33.1 When an entity acquires an interest in a joint operation in which the activity of the joint operation constitutes an operation business, as defined in PBE IPSAS 40 IFRS-3, it shall apply, to the extent of its share in accordance with paragraph 23, all of the principles on acquisition business combinations accounting in PBE IPSAS 40 IFRS-3, and other PBE Standards, that do not conflict with the guidance in this Standard and disclose the information required by those PBE Standards in relation to acquisitions business combinations. The principles on acquisition business combinations accounting that do not conflict with the guidance in this Standard include but are not limited to:

- (a) Measuring identifiable assets and liabilities at fair value, other than items for which exceptions are given in PBE IPSAS 40 IFRS-3 and other PBE Standards;
- (b) Recognising acquisition-related costs as expenses in the periods in which the costs are incurred and the services are received, with the exception that the costs to issue debt or equity securities are recognised in accordance with PBE IPSAS 28 and PBE IPSAS 29;
- (c) Recognising deferred tax assets and deferred tax liabilities that arise from the initial recognition of assets or liabilities, except for deferred tax liabilities that arise from the initial recognition of goodwill, as required by PBE IPSAS 40 IFRS-3 and PBE IAS 12 for acquisitions business combinations;
- (d) Recognising the excess of the consideration transferred over the net of the acquisition-date amounts of the identifiable assets acquired and the liabilities assumed, if any, as goodwill; and
- (e) Testing for impairment a cash-generating unit to which goodwill has been allocated at least annually, and whenever there is an indication that the unit may be impaired, as required by PBE IPSAS 26 *Impairment of Cash-Generating Assets* for goodwill acquired in an acquisition business combination.

AG33.2 Paragraphs 24.1 and AG33.1 also apply to the formation of a joint operation if, and only if, an existing operation business, as defined in PBE IPSAS 40 IFRS-3, is contributed to the joint operation on its formation by one of the parties that participate in the joint operation. However, those paragraphs do not apply to the formation of a joint operation if all of the parties that participate in the joint operation only contribute assets or groups of assets that do not constitute operations businesses to the joint operation on its formation.

AG33.3 A joint operator might increase its interest in a joint operation in which the activity of the joint operation constitutes an operation business, as defined in PBE IPSAS 40 IFRS-3, by acquiring an additional interest in the joint operation. In such cases, previously held interests in the joint operation are not remeasured if the joint operator retains joint control.

AG33.3A A party that participates in, but does not have joint control of, a joint operation might obtain joint control of the joint operation in which the activity of the joint operation constitutes an operation as defined in PBE IPSAS 40 IFRS-3. In such cases, previously held interests in the joint operation are not remeasured.

In the Illustrative Examples, Illustrative examples 8 and 9 are added.

**Example 8—Accounting for Acquisitions of Interests in Joint Operations in which the Activity Constitutes an Operation**

IE60. Municipalities A, B and C have joint control of Joint Operation D whose activity constitutes an operation, as defined in PBE IPSAS 40 *PBE Combinations*.

<sup>18</sup> NZASB ED 2018-3 *2018 Omnibus Amendments to PBE Standards* proposes to add paragraph AG33.3A.

- IE61. Municipality E acquires municipality A's 40 percent ownership interest in Joint Operation D at a cost of CU300 and incurs acquisition-related costs of CU50.
- IE62. The binding arrangement between the parties that Municipality E joined as part of the acquisition establishes that Municipality E's shares in several assets and liabilities differ from its ownership interest in Joint Operation D. The following table sets out Municipality E's share in the assets and liabilities related to Joint Operation D as established in the binding arrangement between the parties:

	<i>Municipality E's share in the assets and liabilities related to Joint Operation D</i>
Property, plant and equipment	48%
Intangible assets (excluding goodwill)	90%
Accounts receivable	40%
Inventory	40%
Retirement benefit obligations	15%
Accounts payable	40%
Contingent liabilities	56%

### Analysis

- IE63. Municipality E recognises in its financial statements its share of the assets and liabilities resulting from the contractual arrangement (see paragraph 23).
- IE64. It applies the principles on acquisition accounting in PBE IPSAS 40 and other PBE Standards for identifying, recognising, measuring and classifying the assets acquired, and the liabilities assumed, on the acquisition of the interest in Joint Operation D. This is because Municipality E acquired an interest in a joint operation in which the activity constitutes an operation (see paragraph 24.1).
- IE65. However, Municipality E does not apply the principles on acquisition accounting in PBE IPSAS 40 and other PBE Standards that conflict with the guidance in this Standard. Consequently, in accordance with paragraph 23, Municipality E recognises, and therefore measures, in relation to its interest in Joint Operation D, only its share in each of the assets that are jointly held and in each of the liabilities that are incurred jointly, as stated in the binding arrangement. Municipality E does not include in its assets and liabilities the shares of the other parties in Joint Operation D.
- IE66. PBE IPSAS 40 requires the acquirer to measure the identifiable assets acquired and the liabilities assumed at their acquisition-date fair values with limited exceptions; for example, a reacquired right recognised as an intangible asset is measured on the basis of the remaining term of the related binding arrangement regardless of whether market participants would consider potential renewals of binding arrangements when measuring its fair value. Such measurement does not conflict with this Standard and thus those requirements apply.
- IE67. Consequently, Municipality E determines the fair value, or other measure specified in PBE IPSAS 40, of its share in the identifiable assets and liabilities related to Joint Operation D. The following table sets out the fair value or other measure specified by PBE IPSAS 40 of Municipality E's shares in the identifiable assets and liabilities related to Joint Operation D:

	<i>Fair value or other measure specified by PBE IPSAS 40 for Municipality E's shares in the identifiable assets and liabilities of Joint Operation D (CU)</i>
Property, plant and equipment	138
Intangible assets (excluding goodwill)	72
Accounts receivable	84

	<i>Fair value or other measure specified by PBE IPSAS 40 for Municipality E's shares in the identifiable assets and liabilities of Joint Operation D (CU)</i>
Inventory	70
Retirement benefit obligations	(12)
Accounts payable	(48)
Contingent liabilities	(52)
Deferred tax liability (see PBE IAS 12 dealing with income taxes)	(24)
<b>Net assets</b>	<b>228</b>

IE68. In accordance with PBE IPSAS 40, the excess of the consideration transferred over the amount allocated to Municipality E's shares in the net identifiable assets is recognised as goodwill:

Consideration transferred	CU300
Municipality E's shares in the identifiable assets and liabilities relating to its interest in the joint operation	CU228
<b>Goodwill</b>	<b>CU72</b>

IE69. Acquisition-related costs of CU50 are not considered to be part of the consideration transferred for the interest in the joint operation. They are recognised as expenses in surplus or deficit in the period that the costs are incurred and the services are received (see paragraph 111 of PBE IPSAS 40).

### **Example 9—Contributing the Right to Use Know-how to a Joint Operation in which the Activity Constitutes an Operation**

IE70. Entities A and B are two entities whose activities are the construction of high performance batteries for diverse applications.

IE71. In order to develop batteries for electric vehicles they set up a binding arrangement (Joint Operation Z) to work together. Entities A and B share joint control of Joint Operation Z. This arrangement is a joint operation in which the activity constitutes an operation, as defined in PBE IPSAS 40.

IE72. After several years, the joint operators (Entities A and B) concluded that it is feasible to develop a battery for electric vehicles using Material M. However, processing Material M requires specialist know-how and thus far, Material M has only been used in electricity generation.

IE73. In order to get access to existing know-how in processing Material M, Entities A and B arrange for Entity C to join as another joint operator by acquiring an interest in Joint Operation Z from Entities A and B and becoming a party to the binding arrangements.

IE74. Entity C's activity so far has been solely the generation of electricity. It has long-standing and extensive knowledge in processing Material M.

IE75. In exchange for its share in Joint Operation Z, Entity C pays cash to Entities A and B and grants the right to use its know-how in processing Material M for the purposes of Joint Operation Z. In addition, Entity C seconded some of its employees who are experienced in processing Material M to Joint Operation Z. However, Entity C does not transfer control of the know-how to Entities A and B or Joint Operation Z because it retains all the rights to it. In particular, Entity C is entitled to withdraw the right to use its know-how in processing Material M and to withdraw its seconded employees without any restrictions or compensation to Entity A and B or Joint Operation Z if it ceases its participation in Joint Operation Z.

IE76. The fair value of Entity C's know-how on the date of the acquisition of the interest in the joint operation is CU1,000. Immediately before the acquisition, the carrying amount of the know-how in the financial statements of Entity C was CU300.

### Analysis

IE77. Entity C has acquired an interest in Joint Operation Z in which the activity of the joint operation constitutes an operation, as defined in PBE IPSAS 40.

IE78. In accounting for the acquisition of its interest in the joint operation, Entity C applies all the principles on acquisition accounting in PBE IPSAS 40 and other PBE Standards that do not conflict with the guidance in this Standard (see paragraph 24.1). Entity C therefore recognises in its financial statements its share of the assets and liabilities resulting from the binding arrangement (see paragraph 23).

IE79. Entity C granted the right to use its know-how in processing Material M to Joint Operation Z as part of joining Joint Operation Z as a joint operator. However, Entity C retains control of this right because it is entitled to withdraw the right to use its know-how in processing Material M and to withdraw its seconded employees without any restrictions or any compensation to Entities A and B or Joint Operation Z if it ceases its participation in Joint Operation Z.

IE80. Consequently, Entity C continues to recognise the know-how in processing Material M after the acquisition of the interest in Joint Operation Z because it retains all the rights to it. This means that Entity C will continue to recognise the know-how based on its carrying amount of CU300. As a consequence of retaining control of the right to use the know-how that it granted to the joint operation, Entity C has granted the right to use the know-how to itself. Consequently, Entity C does not remeasure the know-how, and it does not recognise a gain or loss on the grant of the right to use it.

## Comparison with IPSAS 37

Deleted text is struck through.

PBE IPSAS 37 *Joint Arrangements*, is drawn from IPSAS 37 *Joint Arrangements*. ~~PBE IPSAS 37 includes the IASB's *Accounting for Acquisitions of Interests in Joint Operations* (Amendments to IFRS 11) issued in May 2014 whereas IPSAS 37 does not.~~ There are no other significant differences between PBE IPSAS 37 and IPSAS 37.

## PBE IFRS 4 *Insurance Contracts*

Paragraphs 4, 17, 31 and its related heading, 33 and 34 are amended. Paragraph is 45.7 is added. New text is underlined and deleted text is struck through.

4. An entity shall not apply this Standard to:

...

(e) Contingent consideration payable or receivable in a PBE business combination (see PBE IPSAS 40 ~~IFRS 3~~ PBE Business Combinations).

...

17. If an insurer's accounting policies do not require a liability adequacy test that meets the minimum requirements of paragraph 16, the insurer shall:

(a) Determine the carrying amount of the relevant insurance liabilities<sup>6</sup> less the carrying amount of:

(i) Any related deferred acquisition costs; and

(ii) Any related intangible assets, such as those acquired in a PBE business combination or portfolio transfer (see paragraphs 31 and 32). However, related reinsurance assets are not considered because an insurer accounts for them separately (see paragraph 20).

<sup>6</sup> Footnote 6 is not shown.

...

**Insurance Contracts Acquired in a PBE Business Combination or Portfolio Transfer**

31. To comply with PBE IPSAS 40 ~~IFRS 3~~, an insurer shall, at the acquisition date, measure at fair value the insurance liabilities assumed and insurance assets acquired in a PBE business combination. However, an insurer is permitted, but not required, to use an expanded presentation that splits the fair value of acquired insurance contracts into two components:

...

33. The intangible assets described in paragraphs 31 and 32 are excluded from the scope of PBE IPSAS 26 *Impairment of Cash-Generating Assets* and PBE IPSAS 31. However, PBE IPSAS 26 and PBE IPSAS 31 apply to customer lists and customer relationships reflecting the expectation of future contracts that are not part of the contractual insurance rights and contractual insurance obligations that existed at the date of a PBE business combination or portfolio transfer.

34. Some insurance contracts contain a discretionary participation feature as well as a guaranteed element. The issuer of such a contract:

...

- (c) May recognise all premiums received as revenue without separating any portion that relates to the net assets/equity component. The resulting changes in the guaranteed element and in the portion of the discretionary participation feature classified as a liability shall be recognised in surplus or deficit. If part or all of the discretionary participation feature is classified in net assets/equity, a portion of surplus or deficit may be attributable to that feature (in the same way that a portion may be attributable to non-controlling minority interests). The issuer shall recognise the portion of surplus or deficit attributable to any net assets/equity component of a discretionary participation feature as an allocation of surplus or deficit, not as expense or revenue (see PBE IPSAS 1 *Presentation of Financial Reports*).

...

**45.7 PBE IPSAS 40, issued in [date], amended paragraphs 4, 17, 31 and its related heading, 33, 34, C13.1.1 and its related heading, C13.1.3, C17.5.4, D2.2, D13.3.1 and its related heading and D13.3.3. An entity shall apply those amendments when it applies PBE IPSAS 40.**

In Appendix C, paragraphs C13.1.1 and its related heading, C13.1.3 and C17.5.4 are amended. New text is underlined and deleted text is struck through.

**Life Insurance Contracts Acquired in a PBE Business Combination or Portfolio Transfer**

C13.1.1 To comply with PBE IPSAS 40 ~~IFRS 3~~ PBE Business Combinations, an insurer shall, at the acquisition date, measure at fair value the insurance liabilities assumed and insurance assets acquired in a business combination. However, an insurer is permitted, but not required, to use an expanded presentation that splits the fair value of acquired insurance contracts into two components:

...

C13.1.3 The intangible assets described in paragraphs C13.1.1 and C13.1.2 are excluded from the scope of PBE IPSAS 26 *Impairment of Cash-Generating Assets* and from the scope of PBE IPSAS 31 *Intangible Assets* in respect of recognition and measurement. PBE IPSAS 26 and PBE IPSAS 31 apply to customer lists and customer relationships reflecting the expectation of future contracts that are not part of the contractual insurance rights and contractual insurance obligations that existed at the date of a PBE business combination or portfolio transfer.

C17.5.4 Where a life insurance contract with a discretionary participation feature is issued by a foreign life operation, the issuer of such a contract:

...

- (c) May recognise all premiums received as revenue without separating any portion that relates to the net assets/equity component. The resulting changes in the guaranteed element and in the portion of the discretionary participation feature classified as a liability shall be recognised in surplus or deficit. If part of the entire discretionary participation feature is classified directly in net

assets/equity, a portion of surplus or deficit may be attributable to that feature (in the same way that a portion may be attributable to non-controlling minority interests). The issuer shall recognise the portion of surplus or deficit attributable to any net assets/equity component of a discretionary participation feature as an allocation of surplus or deficit, not as expense or revenue (see PBE IPSAS 1 *Presentation of Financial Reports*);

...

In Appendix D, paragraphs D2.2, D13.3.1 and its related heading and D13.3.3 are amended. New text is underlined and deleted text is struck through.

#### D2.2 **This Appendix does not apply to:**

...

- (d) **Contingent consideration payable or receivable in a PBE ~~business~~ combination (see PBE IPSAS 40 ~~IFRS 3~~ PBE Business Combinations);**

...

### **Portfolio Transfers and PBE Business Combinations**

...

D13.3.1 To comply with PBE IPSAS 40 ~~IFRS 3~~, an insurer shall, at the acquisition date, measure at fair value the insurance liabilities assumed and insurance assets acquired in a PBE ~~business~~ combination. However, an insurer is permitted, but not required, to use an expanded presentation that splits the fair value of acquired insurance contracts into two components:

...

D13.3.3 The intangible assets described in paragraphs D13.3.1 and D13.3.2 are excluded from the scope of PBE IPSAS 26 and PBE IPSAS 31 in respect of recognition and measurement. PBE IPSAS 26 and PBE IPSAS 31 apply to customer lists and customer relationships reflecting the expectation of future contracts that are not part of the contractual insurance rights and contractual insurance obligations that existed at the date of a PBE ~~business~~ combination or portfolio transfer.

## **PBE IFRS 5 *Non-current Assets Held for Sale and Discontinued Operations***

Paragraphs 5B.1 and 16 are amended and paragraph 44.8 is added. New text is underlined and deleted text is struck through.

#### 5B.1 **The following terms are used in this Standard with the meanings specified:**

...

**A disposal group is a group of assets to be disposed of, by sale or otherwise, together as a group in a single transaction, and liabilities directly associated with those assets that will be transferred in the transaction. The group includes goodwill acquired in a PBE ~~business~~ combination if the group is a cash-generating unit to which goodwill has been allocated or if it is an operation within such a cash-generating unit.**

16. If a newly acquired asset (or disposal group) meets the criteria to be classified as held for sale (see paragraph 11), applying paragraph 15 will result in the asset (or disposal group) being measured on initial recognition at the lower of its carrying amount had it not been so classified (for example, cost) and fair value less costs to sell. Hence, if the asset (or disposal group) is acquired as part of a PBE ~~business~~ combination, it shall be measured at fair value less costs to sell.

**44.8 PBE IPSAS 40 *PBE Combinations*, issued in [date], amended paragraphs 5B.1 and 16. An entity shall apply those amendments when it applies PBE IPSAS 40.**

## **PBE IFRS 9 *Financial Instruments*** **(if an entity has early adopted PBE IFRS 9)**

Paragraphs 2.1, 4.2.1 and 5.7.5 are amended and paragraph 7.1.6 is added. New text is underlined and deleted text is struck through.

**2.1 This Standard shall be applied by all entities to all types of financial instruments except:**

...

- (f) any forward contract between an acquirer and a seller to buy or sell an acquired operation acquiree that will result in an PBE entity combination within the scope of PBE IPSAS 40 ~~IFRS 3 *PBE Business Combinations*~~ at a future acquisition date. The term of the forward contract should not exceed a reasonable period normally necessary to obtain any required approvals and to complete the transaction.

...

**4.2.1 An entity shall classify all financial liabilities as subsequently measured at amortised cost, except for:**

...

- (e) contingent consideration recognised by an acquirer in a PBE business combination to which PBE IPSAS 40 ~~IFRS 3~~ applies. Such contingent consideration shall subsequently be measured at fair value with changes recognised in surplus or deficit.

...

**5.7.5 At initial recognition, an entity may make an irrevocable election to present in other comprehensive revenue and expense subsequent changes in the fair value of an investment in an equity instrument within the scope of this Standard that is neither *held for trading* nor contingent consideration recognised by an acquirer in a PBE business combination to which PBE IPSAS 40 ~~IFRS 3~~ applies. (See paragraph B5.7.3 for guidance on foreign exchange gains or losses.)**

...

7.1.6 PBE IPSAS 40 *PBE Combinations*, issued in [date], amended paragraphs 2.1, 4.2.1, 5.7.5, B4.3.12 and B6.3.1. An entity shall apply those amendments when it applies PBE IPSAS 40.

In Appendix B, paragraphs B4.3.12 and B6.3.1 are amended. New text is underlined and deleted text is struck through.

B4.3.12 Paragraph B4.3.11 does not apply to embedded derivatives in contracts acquired in:

- (a) a PBE business combination (as defined in PBE IPSAS 40 ~~IFRS 3 *PBE Business Combinations*~~);  
or
- (b) ~~[Deleted by NZASB] a combination of entities or businesses under common control as described in paragraphs B1–B4 of PBE IFRS 3; or~~
- (c) the formation of a joint venture as defined in PBE IPSAS 37 *Joint Arrangements*<sup>8</sup> or their possible reassessment at the date of acquisition.<sup>9</sup>

<sup>8</sup> Footnote 8 is not shown.

<sup>9</sup> PBE IPSAS 40 ~~IFRS 3~~ addresses the acquisition of contracts with embedded derivatives in a PBE business combination.

...

**B6.3.1 A firm commitment to acquire a business in a PBE business combination cannot be a hedged item, except for foreign currency risk, because the other risks being hedged cannot be specifically identified and measured. Those other risks are general business risks.**

## PBE IAS 12 *Income Taxes*

The objective, paragraphs 15, 18, 19 and its related heading, 21, 21A, 21B, 22, 24, 26, 32A, 37, 51D, 58, 66 and its related heading, 67, 68, 68C and 81 are amended. Paragraph 98.8 is added. New text is underlined and deleted text is struck through.

### Objective

...

This Standard requires an entity to account for the tax consequences of transactions and other events in the same way that it accounts for the transactions and other events themselves. Thus, for transactions and other events recognised in surplus or deficit, any related tax effects are also recognised in surplus or deficit. For transactions and other events recognised outside surplus or deficit (either in other comprehensive revenue and expense or directly in net assets/equity), any related tax effects are also recognised outside surplus or deficit (either in other comprehensive revenue and expense or directly in net assets/equity, respectively). Similarly, the recognition of deferred tax assets and liabilities in a PBE business combination affects the amount of goodwill arising in that PBE business combination or the amount of the bargain purchase gain recognised.

...

15. **A deferred tax liability shall be recognised for all taxable temporary differences, except to the extent that the deferred tax liability arises from:**

- (a) **The initial recognition of goodwill; or**
- (b) **The initial recognition of an asset or liability in a transaction which:**
  - (i) **Is not a PBE business combination; and**

...

18. Temporary differences also arise when:

- (a) The identifiable assets acquired and liabilities assumed in a PBE business combination are recognised at their fair values in accordance with PBE IPSAS 40 ~~IFRS 3~~ PBE Business Combinations, but no equivalent adjustment is made for tax purposes (see paragraph 19);
- (b) Assets are revalued and no equivalent adjustment is made for tax purposes (see paragraph 20);
- (c) Goodwill arises in a PBE business combination (see paragraph 21);

...

### PBE Business Combinations

19. With limited exceptions, the identifiable assets acquired and liabilities assumed in a PBE business combination are recognised at their fair values at the acquisition date. Temporary differences arise when the tax bases of the identifiable assets acquired and liabilities assumed are not affected by the PBE business combination or are affected differently. For example, when the carrying amount of an asset is increased to fair value but the tax base of the asset remains at cost to the previous owner, a taxable temporary difference arises which results in a deferred tax liability. The resulting deferred tax liability affects goodwill (see paragraph 66).

...

21. Goodwill arising in a PBE business combination is measured as the excess of (a) over (b) below:

- (a) The aggregate of:
  - (i) The consideration transferred measured in accordance with PBE IPSAS 40 ~~IFRS 3~~, which generally requires acquisition-date fair value;
  - (ii) The amount of any non-controlling minority interest in the acquired operation ~~acquiree~~ recognised in accordance with PBE IPSAS 40 ~~IFRS 3~~; and



- (iii) In a PBE business combination achieved in stages, the acquisition-date fair value of the acquirer's previously held equity interest in the acquired operation ~~acquiree~~.
  - (b) The net of the acquisition-date amounts of the identifiable assets acquired and liabilities assumed measured in accordance with PBE IPSAS 40 ~~IFRS 3~~.
- ...
- 21A. Subsequent reductions in a deferred tax liability that is unrecognised because it arises from the initial recognition of goodwill are also regarded as arising from the initial recognition of goodwill and are therefore not recognised under paragraph 15(a). For example, if in a PBE business combination an entity recognises goodwill of CU100 that has a tax base of nil, paragraph 15(a) prohibits the entity from recognising the resulting deferred tax liability. If the entity subsequently recognises an impairment loss of CU20 for that goodwill, the amount of the taxable temporary difference relating to the goodwill is reduced from CU100 to CU80, with a resulting decrease in the value of the unrecognised deferred tax liability. That decrease in the value of the unrecognised deferred tax liability is also regarded as relating to the initial recognition of the goodwill and is therefore prohibited from being recognised under paragraph 15(a).
- 21B. Deferred tax liabilities for taxable temporary differences relating to goodwill are, however, recognised to the extent they do not arise from the initial recognition of goodwill. For example, if in a PBE business combination an entity recognises goodwill of CU100 that is deductible for tax purposes at a rate of 20 per cent per year starting in the year of acquisition, the tax base of the goodwill is CU100 on initial recognition and CU80 at the end of the year of acquisition. If the carrying amount of goodwill at the end of the year of acquisition remains unchanged at CU100, a taxable temporary difference of CU20 arises at the end of that year. Because that taxable temporary difference does not relate to the initial recognition of the goodwill, the resulting deferred tax liability is recognised.
22. A temporary difference may arise on initial recognition of an asset or liability, for example if part or all of the cost of an asset will not be deductible for tax purposes. The method of accounting for such a temporary difference depends on the nature of the transaction that led to the initial recognition of the asset or liability:
- (a) In a PBE business combination, an entity recognises any deferred tax liability or asset and this affects the amount of goodwill or bargain purchase gain it recognises (see paragraph 19);
  - (b) If the transaction affects either accounting profit or taxable profit, an entity recognises any deferred tax liability or asset and recognises the resulting deferred tax expense or income in surplus or deficit (see paragraph 59);
  - (c) If the transaction is not a PBE business combination, and affects neither accounting profit nor taxable profit, an entity would, in the absence of the exemption provided by paragraphs 15 and 24, recognise the resulting deferred tax liability or asset and adjust the carrying amount of the asset or liability by the same amount. Such adjustments would make the financial statements less transparent. Therefore, this Standard does not permit an entity to recognise the resulting deferred tax liability or asset, either on initial recognition or subsequently. Furthermore, an entity does not recognise subsequent changes in the unrecognised deferred tax liability or asset as the asset is depreciated.
- ...
24. **A deferred tax asset shall be recognised for all deductible temporary differences to the extent that it is probable that taxable profit will be available against which the deductible temporary difference can be utilised, unless the deferred tax asset arises from the initial recognition of an asset or liability in a transaction that:**
- (a) **Is not a PBE business combination; and**
- ...
26. The following are examples of deductible temporary differences that result in deferred tax assets:
- ...
- (c) With limited exceptions, an entity recognises the identifiable assets acquired and liabilities assumed in a PBE business combination at their fair values at the acquisition date. When a liability assumed

is recognised at the acquisition date but the related costs are not deducted in determining taxable profits until a later period, a deductible temporary difference arises which results in a deferred tax asset. A deferred tax asset also arises when the fair value of an identifiable asset acquired is less than its tax base. In both cases, the resulting deferred tax asset affects goodwill (see paragraph 66); and

...

- 32A. If the carrying amount of goodwill arising in a PBE business combination is less than its tax base, the difference gives rise to a deferred tax asset. The deferred tax asset arising from the initial recognition of goodwill shall be recognised as part of the accounting for a PBE business combination to the extent that it is probable that taxable profit will be available against which the deductible temporary difference could be utilised.

...

37. At the end of each reporting period, an entity reassesses unrecognised deferred tax assets. The entity recognises a previously unrecognised deferred tax asset to the extent that it has become probable that future taxable profit will allow the deferred tax asset to be recovered. For example, an improvement in trading conditions may make it more probable that the entity will be able to generate sufficient taxable profit in the future for the deferred tax asset to meet the recognition criteria set out in paragraphs 24 or 34. Another example is when an entity reassesses deferred tax assets at the date of a PBE business combination or subsequently (see paragraphs 67 and 68).

...

- 51D. The rebuttable presumption in paragraph 51C also applies when a deferred tax liability or a deferred tax asset arises from measuring investment property in a PBE business combination if the entity will use the fair value model when subsequently measuring that investment property.

...

58. **Current and deferred tax shall be recognised as revenue or an expense and included in the surplus or deficit for the period, except to the extent that the tax arises from:**

...

- (b) **A PBE business combination (other than the acquisition by an investment entity, as defined in PBE IPSAS 35 *Consolidated Financial Statements*, of a controlled entity that is required to be measured at fair value through surplus or deficit) (see paragraphs 66 to 68).**

...

#### **Deferred Tax Arising from a PBE Business Combination**

66. As explained in paragraphs 19 and 26(c), temporary differences may arise in a PBE business combination. In accordance with PBE IPSAS 40 IFRS-3, an entity recognises any resulting deferred tax assets (to the extent that they meet the recognition criteria in paragraph 24) or deferred tax liabilities as identifiable assets and liabilities at the acquisition date. Consequently, those deferred tax assets and deferred tax liabilities affect the amount of goodwill or the bargain purchase gain the entity recognises. However, in accordance with paragraph 15(a), an entity does not recognise deferred tax liabilities arising from the initial recognition of goodwill.
67. As a result of a PBE business combination, the probability of realising a pre-acquisition deferred tax asset of the acquirer could change. An acquirer may consider it probable that it will recover its own deferred tax asset that was not recognised before the PBE business combination. For example, the acquirer may be able to utilise the benefit of its unused tax losses against the future taxable profit of the acquired operation acquiree. Alternatively, as a result of the PBE business combination it might no longer be probable that future taxable profit will allow the deferred tax asset to be recovered. In such cases, the acquirer recognises a change in the deferred tax asset in the period of the PBE business combination, but does not include it as part of the accounting for the PBE business combination. Therefore, the acquirer does not take it into account in measuring the goodwill or bargain purchase gain it recognises in the PBE business combination.
68. The potential benefit of the acquired operation's acquiree's income tax loss carryforwards or other deferred tax assets might not satisfy the criteria for separate recognition when a PBE business combination is

initially accounted for but might be realised subsequently. An entity shall recognise acquired deferred tax benefits that it realises after the PBE business combination as follows:

...

- 68C. As noted in paragraph 68A, the amount of the tax deduction (or estimated future tax deduction, measured in accordance with paragraph 68B) may differ from the related cumulative remuneration expense. Paragraph 58 of the Standard requires that current and deferred tax should be recognised as income or an expense and included in surplus or deficit for the period, except to the extent that the tax arises from (a) a transaction or event that is recognised, in the same or a different period, outside surplus or deficit, or (b) a PBE business combination (other than the acquisition by an investment entity of a controlled entity that is required to be measured at fair value through surplus or deficit). If the amount of the tax deduction (or estimated future tax deduction) exceeds the amount of the related cumulative remuneration expense, this indicates that the tax deduction relates not only to remuneration expense but also to an equity item. In this situation, the excess of the associated current or deferred tax should be recognised directly in net assets/equity.

...

81. **The following shall also be disclosed separately:**

...

- \*(j) If a PBE business combination in which the entity is the acquirer causes a change in the amount recognised for its pre-acquisition deferred tax asset (see paragraph 67), the amount of that change; and**
- \*(k) If the deferred tax benefits acquired in a PBE business combination are not recognised at the acquisition date but are recognised after the acquisition date (see paragraph 68), a description of the event or change in circumstances that caused the deferred tax benefits to be recognised.**

...

- 98.8 PBE IPSAS 40, issued in [date], amended paragraphs 15, 18, 19 and its related heading, 21, 21A, 21B, 22, 24, 26, 32A, 37, 51D, 58, 66 and its related heading, 67, 68, 68C and 81. An entity shall apply those amendments when it applies PBE IPSAS 40.**

## **PBE IAS 34 *Interim Financial Reporting***

Paragraph 16A is amended and paragraph 49.11 is added. New text is underlined and deleted text is struck through.

- 16A. **In addition to disclosing significant events and transactions in accordance with paragraphs 15–15C, an entity shall include the following information, in the notes to its interim financial statements or elsewhere in the interim financial report. The following disclosures shall be given either in the interim financial statements or incorporated by cross-reference from the interim financial statements to some other statement (such as management commentary or risk report) that is available to users of the financial statements on the same terms as the interim financial statements and at the same time. If users of the financial statements do not have access to the information incorporated by cross-reference on the same terms and at the same time, the interim financial report is incomplete. The information shall normally be reported on a financial year-to-date basis.**

...

- (i) The effect of changes in the composition of the entity during the interim period, including PBE business combinations, obtaining or losing control of controlled entities and long-term investments, restructurings, and discontinued operations. In the case of PBE business combinations, the entity shall disclose the information required by PBE IPSAS 40 ~~IFRS 3~~ PBE *Business Combinations*.**

...

- 49.11 PBE IPSAS 40, issued in [date], amended paragraph 16A. An entity shall apply that amendment when it applies PBE IPSAS 40.**

## **PBE FRS 46 *First-time Adoption of PBE Standards by Entities Previously Applying NZ IFRS***

Paragraph 10 is amended. Paragraph 29.1 and its related heading and paragraph 43.3 are added. New text is underlined.

10. Except where otherwise required by PBE Standards, and subject to the provisions in paragraph 13, paragraph 17 and paragraphs 22–29.1 of this Standard, an entity that previously presented general purpose financial statements in accordance with NZ IFRS shall apply the same recognition and measurement policies for those transactions and events in its first set of financial statements under PBE Standards.

### **PBE IPSAS 40 *PBE Combinations***

29.1 An entity shall not apply PBE IPSAS 40 to any PBE combinations for which the amalgamation date or acquisition date is before the date of transition to PBE Standards. An entity is not required to restate PBE combinations that occurred before the date of transition to PBE Standards.

...

43.3 PBE IPSAS 40, issued in [date], amended paragraph 10 and added paragraph 29.1 and its related heading. An entity shall apply those amendments when it applies PBE IPSAS 40.

In the Basis for Conclusions, paragraph BC7.1 is added. New text is underlined

BC7.1 In [date] the NZASB issued PBE IPSAS 40 *PBE Combinations* which superseded PBE IFRS 3 *Business Combinations*). The NZASB decided to amend PBE FRS 46 to make it clear that first-time adopters are not permitted to apply PBE IPSAS 40 to any previous PBE combinations that occurred before the date of transition to PBE Standards and to not to restate PBE combinations that occurred before the date of transition to PBE Standards.

## **PBE FRS 47 *First-time Adoption of PBE Standards by Entities Other Than Those Previously Applying NZ IFRS***

Paragraph 42.8 is added. New text is underlined.

42.8 PBE IPSAS 40, issued in [date], amended paragraphs A1, the title of Appendix B and the sentence following the title, B1, B2–B5, C13, C14, and added paragraph A7 and its related heading, the heading before paragraph B2, and paragraphs B6–B9 and their related heading. An entity shall apply those amendments when it applies PBE IPSAS 40.

In Appendix A, paragraph A1 is amended. Paragraph A7 and its related heading are added. New text is underlined and deleted text is struck through.

- A1. An entity shall apply the following exceptions:
- (a) Derecognition of financial assets and financial liabilities (paragraphs A2 and A3); ~~and~~
  - (b) Hedge accounting (paragraphs A4–A6); ~~and~~
  - (c) Non-controlling interests (paragraph A7).

...

### **Non-controlling Interests**

A7. A first-time adopter shall apply the following requirements of PBE IPSAS 35 prospectively from the date of transition to PBE Standards:

- (a) The requirement in paragraph 49 that total comprehensive revenue and expense is attributed to the owners of the controlling entity and to the non-controlling interests even if this results in the non-controlling interests having a deficit balance;

- (b) The requirements in paragraphs 48 and 51 for accounting for changes in the controlling entity's ownership interest in a controlled entity that do not result in a loss of control; and
- (c) The requirements in paragraphs 53–55 for accounting for a loss of control over a controlled entity, and the related requirements of paragraph 8A of PBE IFRS 5 *Non-current Assets Held for Sale and Discontinued Operations*.

However, if a first-time adopter elects to apply PBE IPSAS 40 *PBE Combinations* retrospectively to past PBE combinations, it also shall apply PBE IPSAS 35 in accordance with paragraph B1 of this Standard.

In Appendix B, the title of the appendix and the sentence following the title, paragraph B1, and paragraphs B2–B5 are amended. The heading before paragraph B2 and paragraphs B6–B9 and their related heading are added. New text is underlined and deleted text is struck through.

## Exemptions for PBE Business Combinations

*This Appendix is an integral part of PBE FRS 47. An entity shall apply the following requirements to PBE business combinations that the entity recognised before the date of transition to PBE Standards.*

- B1. A first-time adopter may elect not to apply PBE IPSAS 40 ~~IFRS 3~~ PBE Business Combinations retrospectively to past PBE business combinations (PBE business combinations that occurred before the date of transition to PBE Standards). However, if a first-time adopter restates any PBE business combination to comply with PBE IPSAS 40 ~~IFRS 3~~, it shall restate all later PBE business combinations and shall also apply PBE IPSAS 35 *Consolidated Financial Statements* from that same date. For example, if a first-time adopter elects to restate a PBE business combination that occurred on 30 June 20X6, it shall restate all PBE business combinations that occurred between 30 June 20X6 and the date of transition to PBE Standards, and it shall also apply PBE IPSAS 35 from 30 June 20X6.

## Acquisitions

- B2. An entity need not apply PBE IPSAS 4 *The Effects of Changes in Foreign Exchange Rates* retrospectively to fair value adjustments and goodwill arising in PBE business combinations that occurred before the date of transition to PBE Standards. If the entity does not apply PBE IPSAS 4 retrospectively to those fair value adjustments and goodwill, it shall treat them as assets and liabilities of the entity rather than as assets and liabilities of the acquired operation acquiree. Therefore, those goodwill and fair value adjustments either are already expressed in the entity's functional currency or are non-monetary foreign currency items, which are reported using the exchange rate applied in accordance with previous GAAP.
- B3. An entity may apply PBE IPSAS 4 retrospectively to fair value adjustments and goodwill arising in either:
- All PBE business combinations that occurred before the date of transition to PBE Standards; or
  - All PBE business combinations that the entity elects to restate to comply with PBE IPSAS 40 ~~IFRS 3~~, as permitted by paragraph B1 above.
- B4. If a first-time adopter does not apply PBE IPSAS 40 ~~IFRS 3~~ retrospectively to a past acquisition business combination, this has the following consequences for that PBE business combination:
- The first-time adopter shall retain ~~keep~~ the ~~same~~ classification (as an acquisition by the legal acquirer, or a reverse acquisition by the legal acquired operation acquiree, ~~or a uniting of interests~~) as in its previous GAAP financial statements.
  - At the date of transition to PBE Standards ~~The first-time adopter shall recognise all its assets and liabilities at the date of transition to PBE Standards that it were~~ acquired or assumed in a past PBE business combination, other than:
    - Some financial assets and financial liabilities derecognised in accordance with previous GAAP (see paragraph A2); and
    - Assets, including goodwill, and liabilities that were not recognised in the acquirer's consolidated statement of financial position in accordance with previous GAAP and which ~~also~~ would not qualify for recognition in accordance with PBE Standards in the separate statement of financial position of the acquired operation acquiree (see (f)–(i) below).

The first-time adopter shall recognise any resulting change by adjusting accumulated comprehensive revenue and expense (or, if appropriate, another category of net assets/equity), unless the change results from the recognition of an intangible asset that was previously subsumed within goodwill (see (g)(i) below).

- (c) The first-time adopter shall exclude from its opening statement of financial position under PBE Standards any item recognised in accordance with previous GAAP that does not qualify for recognition as an asset or liability under PBE Standards. The first-time adopter shall account for the resulting change as follows:

- (i) The first-time adopter may have classified a past ~~PBE business~~ combination as an acquisition and recognised as an intangible asset an item that does not qualify for recognition as an asset in accordance with PBE IPSAS 31 *Intangible Assets*. It shall reclassify that item (and, if any, the related deferred tax and non-controlling interests) as part of goodwill (unless it deducted goodwill directly from net assets/equity in accordance with previous GAAP, see (g)(i) and (ii) below).
- (ii) The first-time adopter shall recognise all other resulting changes in accumulated comprehensive revenue and expense.\*

\* Such changes include reclassifications from or to intangible assets if goodwill was not recognised in accordance with previous GAAP as an asset. This arises if, in accordance with previous GAAP, the entity (a) deducted goodwill directly from net assets/equity or (b) did not treat the ~~PBE business~~ combination as an acquisition.

- (d) PBE Standards require subsequent measurement of some assets and liabilities on a basis that is not based on original cost, such as fair value. The first-time adopter shall measure ~~these~~ such assets and liabilities ~~on that basis~~ in its opening statement of financial position on the basis required by ~~under~~ PBE Standards, even if they were acquired or assumed in a past ~~PBE business~~ combination. It shall recognise any resulting change in the carrying amount by adjusting accumulated comprehensive revenue and expense (or, if appropriate, another category of net assets/equity), rather than goodwill.
- (e) Immediately after the ~~PBE business~~ combination, the carrying amount in accordance with previous GAAP of assets acquired and liabilities assumed in that ~~PBE business~~ combination shall be their deemed cost in accordance with PBE Standards at that date. If PBE Standards require a cost-based measurement of those assets and liabilities at a later date, that deemed cost shall be the basis for cost-based depreciation or amortisation from the date of the ~~PBE business~~ combination.
- (f) If an asset acquired, or liability assumed, in a past ~~PBE business~~ combination was not recognised in accordance with previous GAAP, it does not have a deemed cost of zero in the opening statement of financial position under PBE Standards. Instead, the acquirer shall recognise and measure it in its consolidated statement of financial position on the basis that PBE Standards would require in the statement of financial position of the acquired operation ~~acquiree~~. To illustrate: if the acquirer had not, in accordance with its previous GAAP, capitalised finance leases acquired in a past ~~PBE business~~ combination, it shall capitalise those leases in its consolidated financial statements, as PBE IPSAS 13 *Leases* would require the acquiree to do in its statement of financial position under PBE Standards. Similarly, if the acquirer had not, in accordance with its previous GAAP, recognised a contingent liability that still exists at the date of transition to PBE Standards, the acquirer shall recognise that contingent liability at that date unless PBE IPSAS 19 *Provisions, Contingent Liabilities and Contingent Assets* would prohibit its recognition in the financial statements of the acquired operation ~~acquiree~~. Conversely, if an asset or liability was subsumed in goodwill in accordance with previous GAAP but would have been recognised separately under PBE ~~IPSAS 40 IFRS-3~~, that asset or liability remains in goodwill unless PBE Standards would require its recognition in the financial statements of the acquired operation ~~acquiree~~.

...

- (h) No other adjustments shall be made to the carrying amount of goodwill at the date of transition to PBE Standards. For example, the first-time adopter shall not restate the carrying amount of goodwill:

- (i) To exclude in-process research and development acquired in that ~~PBE business~~ combination (unless the related intangible asset would qualify for recognition in accordance with PBE IPSAS 31 in the statement of financial position of the acquired operation ~~acquiree~~);

- (ii) To adjust previous amortisation of goodwill; or
- (iii) To reverse adjustments to goodwill that PBE ~~IPSAS 40 IFRS 3~~ would not permit, but were made in accordance with previous GAAP because of adjustments to assets and liabilities between the date of the PBE business combination and the date of transition to PBE Standards.

...

- (j) In accordance with its previous GAAP, the first-time adopter may not have consolidated a controlled entity acquired in a past PBE business combination (for example, because the controlling entity did not regard it as a controlled entity in accordance with previous GAAP or did not prepare consolidated financial statements). The first-time adopter shall adjust the carrying amounts of the controlled entity's assets and liabilities to the amounts that PBE Standards would require in the controlled entity's statement of financial position. The deemed cost of goodwill equals the difference at the date of transition to PBE Standards between:

...

- B5. The exemption for past PBE business combinations also applies to past acquisitions of investments in associates and of interests in joint ventures and interests in joint operations in which the activity of the joint operation constitutes an operation as defined in PBE IPSAS 40. Furthermore, the date selected for paragraph B1 applies equally for all such acquisitions.

### Amalgamations

- B6. An entity need not apply PBE IPSAS 4 retrospectively to fair value adjustments and goodwill arising in PBE combinations that occurred before the date of transition to PBE Standards. If the entity does not apply PBE IPSAS 4 retrospectively to those fair value adjustments and goodwill, it shall treat them as assets and liabilities of the entity rather than as assets and liabilities of the combining operations. Therefore, those goodwill and fair value adjustments either are already expressed in the entity's functional currency or are non-monetary foreign currency items, which are reported using the exchange rate applied in accordance with previous GAAP.

- B7. An entity may apply PBE IPSAS 4 retrospectively to fair value adjustments and goodwill arising in either:
- (a) All PBE combinations that occurred before the date of transition to PBE Standards; or
  - (b) All PBE combinations that the entity elects to restate to comply with PBE IPSAS 40, as permitted by paragraph B1 above.

- B8. If a first-time adopter does not apply PBE IPSAS 40 retrospectively to a past amalgamation, this has the following consequences for that PBE combination:

- (a) The first-time adopter shall retain the classification of the combination (that is, as an amalgamation or an acquisition) in its previous GAAP financial statements.
- (b) At the date of transition to PBE Standards the first-time adopter shall recognise all the assets and liabilities that it received and assumed in a past amalgamation, other than:
  - (i) Some financial assets and financial liabilities derecognised in accordance with previous GAAP (see paragraph A2); and
  - (ii) Assets, including goodwill, and liabilities that were not recognised in the resulting entity's statement of financial position in accordance with previous GAAP and which would not qualify for recognition in accordance with PBE Standards in the separate statement of financial position of the combining operations (see (f)–(i) below).

The first-time adopter shall recognise any resulting change by adjusting accumulated comprehensive revenue and expense (or, if appropriate, another category of net assets/equity), unless the change results from the recognition of an intangible asset that was previously subsumed within goodwill (see (g)(i) below).

- (c) The first-time adopter shall exclude from its opening statement of financial position under PBE Standards any item recognised in accordance with previous GAAP that does not qualify for

recognition as an asset or liability under PBE Standards. The first-time adopter shall account for the resulting change as follows:

- (i) The first-time adopter may have classified a past PBE combination as an acquisition and recognised as an intangible asset an item that does not qualify for recognition as an asset in accordance with PBE IPSAS 31. It shall reclassify that item (and, if any, the related deferred tax and non-controlling interests) as part of goodwill (unless it deducted goodwill directly from net assets/equity in accordance with previous GAAP, see (g)(i) and (g)(ii) below).
- (ii) The first-time adopter shall recognise all other resulting changes in accumulated comprehensive revenue and expense.\*

\* Such changes include reclassifications from or to intangible assets if goodwill was not recognised in accordance with previous GAAP as an asset. This arises if, in accordance with previous GAAP, the entity deducted goodwill directly from net assets/equity.

- (d) PBE Standards require subsequent measurement of some assets and liabilities on a basis that is not based on original cost, such as fair value. The first-time adopter shall measure such assets and liabilities in its opening statement of financial position on the basis required by PBE Standards, even if they were received or assumed in a past amalgamation. It shall recognise any resulting change in the carrying amount by adjusting accumulated comprehensive revenue and expense (or, if appropriate, another category of net assets/equity).
- (e) Immediately after the amalgamation, the carrying amount in accordance with previous GAAP of assets received and liabilities assumed in that PBE combination shall be their deemed cost in accordance with PBE Standards at that date. If PBE Standards require a cost-based measurement of those assets and liabilities at a later date, that deemed cost shall be the basis for cost-based depreciation or amortisation from the date of the PBE combination.
- (f) If an asset received, or liability assumed, in a past amalgamation was not recognised in accordance with previous GAAP, it does not have a deemed cost of zero in the opening statement of financial position under PBE Standards. Instead, the resulting entity shall recognise and measure it in its statement of financial position on the basis that PBE Standards would require in the statement of financial position of the combining operation. To illustrate: if the resulting entity had not, in accordance with its previous GAAP, capitalised finance leases assumed in a past amalgamation, it shall capitalise those leases in its first set of financial statements under PBE Standards, as PBE IPSAS 13 would require the combining operation to do in its statement of financial position under PBE Standards. Similarly, if the resulting entity had not, in accordance with its previous GAAP, recognised a contingent liability that still exists at the date of transition to PBE Standards, the resulting entity shall recognise that contingent liability at that date unless PBE IPSAS 19 would prohibit its recognition in the financial statements of the combining operations. Conversely, if an asset or liability was subsumed in goodwill in accordance with previous GAAP but would have been recognised separately under PBE IPSAS 40, that asset or liability remains in goodwill unless PBE Standards would require its recognition in the financial statements of the resulting entity.
- (g) The carrying amount of goodwill in the opening statement of financial position under PBE Standards shall be its carrying amount in accordance with previous GAAP at the date of transition to PBE Standards, after the following two adjustments:
  - (i) If required by (c)(i) above, the first-time adopter shall increase the carrying amount of goodwill when it reclassifies an item that it recognised as an intangible asset in accordance with previous GAAP. Similarly, if (f) above requires the first-time adopter to recognise an intangible asset that was subsumed in recognised goodwill in accordance with previous GAAP, the first-time adopter shall decrease the carrying amount of goodwill accordingly (and, if applicable, adjust deferred tax and non-controlling interests).
  - (ii) Regardless of whether there is any indication that the goodwill may be impaired, the first-time adopter shall apply PBE IPSAS 26 in testing the goodwill for impairment at the date of transition to PBE Standards and in recognising any resulting impairment loss in accumulated comprehensive revenue and expense. The impairment test shall be based on conditions at the date of transition to PBE Standards.



- (h) No other adjustments shall be made to the carrying amount of goodwill at the date of transition to PBE Standards. For example, the first-time adopter shall not restate the carrying amount of goodwill:
- (i) To exclude in-process research and development assumed in that PBE combination (unless the related intangible asset would qualify for recognition in accordance with PBE IPSAS 31 in the statement of financial position of the resulting entity);
  - (ii) To adjust previous amortisation of goodwill; or
  - (iii) To reverse adjustments to goodwill that PBE IPSAS 40 would not permit, but were made in accordance with previous GAAP because of adjustments to assets and liabilities between the date of the amalgamation and the date of transition to PBE Standards.
- (i) If the first-time adopter recognised goodwill in accordance with previous GAAP as a deduction from net assets/equity it shall not recognise that goodwill in its opening statement of financial position under PBE Standards.
- (j) In accordance with its previous GAAP, the first-time adopter may not have recognised the assets received and liabilities assumed in a previous amalgamation. The first-time adopter shall adjust the carrying amounts of the resulting entity's assets and liabilities to the amounts that PBE Standards would require in the resulting entity's statement of financial position. The adjustments shall be recognised by adjusting the accumulated comprehensive revenue or expense (or, if appropriate, another category of net assets/equity).
- (k) The measurement of non-controlling interests and deferred tax follows from the measurement of other assets and liabilities. Therefore, the above adjustments to recognised assets and liabilities affect non-controlling interests and deferred tax.

B9. The exemption for past PBE combinations also applies to past amalgamations of investments in associates and of interests in joint ventures and interests in joint operations in which the activity of the joint operation constitutes an operation as defined in PBE IPSAS 40. Furthermore, the date selected for paragraph B1 applies equally for all such amalgamations.

In Appendix C, paragraphs C13–C14 are amended. New text is underlined and deleted text is struck through.
---

...

- C13. If a controlled entity becomes a first-time adopter later than its controlling entity, the controlled entity shall, in its financial statements, measure its assets and liabilities at either:
- (a) The carrying amounts that would be included in the controlling entity's consolidated financial statements, based on the controlling entity's date of transition to PBE Standards, if no adjustments were made for consolidation procedures and for the effects of the PBE business combination in which the controlling entity acquired the controlled entity (this election is not available to a controlled entity of an investment entity, as defined in PBE IPSAS 35, that is required to be measured at fair value through surplus or deficit); or

...

- C14. However, if an entity becomes a first-time adopter later than its controlled entity (or associate or joint venture) the entity shall, in its consolidated financial statements, measure the assets and liabilities of the controlled entity (or associate or joint venture) at the same carrying amounts as in the financial statements of the controlled entity (or associate or joint venture), after adjusting for consolidation and equity accounting adjustments and for the effects of the PBE business combination in which the entity acquired the controlled entity. Similarly, if a controlling entity becomes a first-time adopter for its separate financial statements earlier or later than for its consolidated financial statements, it shall measure its assets and liabilities at the same amounts in both financial statements, except for consolidation adjustments.

## ***XRB A1 Application of the Accounting Standards Framework***

Appendix C is amended. New text is underlined.

### **APPENDIX C**

#### **TIER 1 PBE ACCOUNTING REQUIREMENTS AND TIER 2 PBE ACCOUNTING REQUIREMENTS TO BE APPLIED BY PUBLIC BENEFIT ENTITIES**

*This appendix forms an integral part of XRB A1 Application of the Accounting Standards Framework.*

...

#### **Accounting Standards**

...

PBE IPSAS 39

*Employee Benefits*

PBE IPSAS 40

*PBE Combinations*

PBE IFRS 3

*Business Combinations* (superseded on adoption of PBE IPSAS 40)

...

## Basis for Conclusions

*This Basis for Conclusions accompanies, but is not part of, PBE IPSAS 40.*

### Introduction

- BC1. The New Zealand Accounting Standards Board (NZASB) has modified IPSAS 40 *Public Sector Combinations* for application by Tier 1 and Tier 2 public benefit entities (PBEs). Where applicable, disclosure concessions have been identified for Tier 2 entities and the language generalised for use by PBEs. The NZASB considers that the requirements of IPSAS 40 are generally appropriate for application by PBEs except for the matters discussed below.
- BC2. In developing the Standard the NZASB considered:
- (a) The differences between IPSAS 40 and IFRS 3 *Business Combinations* in respect of accounting for acquisitions – why the IPSASB had diverged from IFRS 3 and whether those divergences would cause any problems for New Zealand PBEs;
  - (b) The distinction between amalgamations and acquisitions – whether this distinction is clear enough and whether the proposed approach to classification would lead to sensible answers in New Zealand; and
  - (c) Whether there were any requirements which might be open to interpretation or could be clarified.
- BC3. As a result of considering these matters the NZASB modified a number of the requirements in IPSAS 40. The significant changes to the requirements of IPSAS 40 are discussed in this Basis for Conclusions. The types of changes made by the NZASB included:
- (a) Changes to the requirements in IPSAS 40;
  - (b) Clarifications to the guidance in IPSAS 40;
  - (c) Not-for-profit (NFP) enhancements to ensure that the Standard is appropriate for application by NFP PBEs as well as public sector PBEs; and
  - (d) Changes to ensure coherence within the suite of PBE Standards by acknowledging the existence of certain PBE Standards (for example, PBE IFRS 5 *Non-current Assets Held for Sale and Discontinued Operations*) for which there is no corresponding IPSAS.

### Indicators Relating to Consideration

- BC4. The NZASB reflected on the types of PBE combinations that it has observed in New Zealand and the role of consideration in those combinations. The NZASB noted that the absence of consideration is a common feature of PBE combinations, and was of the view that the absence of consideration, in itself, does not provide evidence that the combination is an amalgamation. The NZASB was concerned that application of the guidance in IPSAS 40 about consideration, without any changes, could lead to some PBE combinations, particularly some involving NFP entities, being inappropriately classified as amalgamations. For example, the NZASB considered that a transaction involving a donated operation could be an acquisition. This led the NZASB to modify the sections of IPSAS 40 dealing with consideration and the classification of combinations.
- BC5. Paragraph 12 of IPSAS 40 sets out indicators supporting the classification of a combination as an amalgamation. That paragraph read as follows:
12. The following indicators may provide evidence that the combination is an amalgamation:
- (a) Consideration is paid for reasons other than to compensate those with an entitlement to the net assets of a transferred operation for giving up that entitlement (paragraphs AG27–AG28 provide additional guidance);
  - (b) Consideration is not paid to those with an entitlement to the net assets of a transferred operation (paragraphs AG29–AG30 provide additional guidance); or

- (c) Consideration is not paid because there is no-one (whether an individual or an entity) with an entitlement to the net assets of a transferred entity (paragraph AG31 provides additional guidance).
- BC6. The NZASB combined the indicators in paragraphs 12(a) and 12(b) and removed the indicator in paragraph 12(c). The NZASB combined paragraphs 12(a) and 12(b) because of its view that, on its own, the indicator in paragraph 12(a) is not a helpful indicator of an amalgamation. The NZASB was of the view that, when classifying combinations, it is necessary to consider the reasons why no consideration has been paid to compensate those with an entitlement to the net assets of a transferred operation.
- BC7. Consistent with its view that the absence of consideration does not in itself provide evidence that a PBE combination is an amalgamation, and the broader view of equity interests and owners by PBEs in New Zealand, the NZASB removed paragraph 12(c). In the New Zealand public sector and NFP sector the concept of equity interests is not limited to equity participants with an equity instrument, and the use of the term owners is not limited to owners with a quantifiable ownership interest.
- BC8. The changes to the indicators in paragraph 12 led to a number of other changes throughout the Standard including:
- (a) The reordering of the guidance in paragraphs AG27–AG30;
  - (b) The replacement of the examples in paragraph AG30;
  - (c) The removal of paragraph AG31 which contained guidance on paragraph 12(c);
  - (d) The removal of the reference to the indicator in paragraph 12(c) in the illustrative examples (scenario 2 variation, scenario 3 and scenario 14);
  - (e) The updating of the analysis in the illustrative examples; and
  - (f) The reclassification of scenario 6 in the illustrative examples from an amalgamation to an acquisition.

#### **Definitions of Equity Interests and Owners**

- BC9. The NZASB modified the definitions of equity interests and owners in IPSAS 40 to broadly align the definitions with those used in PBE IFRS 3 *Business Combinations*. The NZASB was of the view that these definitions should be broad enough to capture the different types of PBEs and different types of residual interests in PBEs in New Zealand.
- BC10. As a result of changing these definitions the NZASB also replaced the phrase “quantifiable ownership interests” with “equity interests” where appropriate.

#### **Use of the Term New Entity**

- BC11. The meaning of the term “new entity” in IPSAS 40 is unclear because IPSAS 40 uses the same term to refer to both new legal entities and new economic entities (paragraphs AG17 and AG22 of IPSAS 40 as shown below).
- BC12. IPSAS 40 also uses the term “new entity” inconsistently. For example, paragraphs AG1 (as shown below) and AG22 take the view that an amalgamation creates a new entity but there are different presentation requirements for amalgamations in IPSAS 40 depending upon whether the amalgamation results in a new entity or a continuing entity (paragraphs 50 and 51 of IPSAS 40 as shown below).
50. Except where a resulting entity is not a new entity following a public sector combination, the resulting entity’s first set of financial statements following the amalgamation shall comprise: ...
51. Where a resulting entity is not a new entity following a public sector combination, the resulting entity shall disclose: ...
- AG1. Paragraph 5 of this Standard defines a resulting entity as “the entity that is the result of two or more operations combining in an amalgamation.” A resulting entity is not initially a party to the public sector combination. A resulting entity may have the legal form of a new entity, or may retain the legal identity of one of the combining operations. However, a resulting entity usually has the economic substance of a new entity. In a combination in which one party to the combination gains control of one or more operations,

and in which the economic substance is that of an amalgamation, the nature of the combination is usually that the resulting entity has the substance of a new entity.

- AG17. In a public sector combination in which a new entity is formed to effect the combination, that entity may gain control of operations only where the entity exists prior to the combination taking place. Where this new entity does not exist prior to the combination taking place, an entity considers whether one of the parties to the combination that existed prior to the combination taking place gains control of operations.
- AG22. The economic substance of an amalgamation is usually that a new entity is formed, irrespective of the legal form of the resulting entity. This applies equally to a combination in which one party to the combination gains control of one or more operations. If the economic substance of a public sector combination is that one of the parties to the combination continues to exist, this may provide evidence that the economic substance of the combination is that of an acquisition. In combinations of operations under common control, the fact that the ultimate controlling entity controls the operations both before and after the combination reduces the significance of this factor.
- BC13. These inconsistencies and lack of clarity caused the NZASB to review the use of the term “new entity” and “continuing entity”. Providing clarity is important because it affects presentation, disclosure and how to apply the modified pooling of interests method. The NZASB thought the best way to clarify these terms was to specify when a *new reporting entity* and *continuing reporting entity* can arise from an amalgamation.
- BC14. When considering how best to provide that clarity, the NZASB noted that IPSAS 40 contains requirements for two types of amalgamations, which could be used to differentiate between a new reporting entity and a continuing reporting entity. These two types of amalgamations are as follows.
- (a) Amalgamations in which no party to an amalgamation gains control of one or more operations as a result of an amalgamation (see paragraph 7 of the Standard).
  - (b) Amalgamations in which one party to the combination gains control of one or more operations but the entity determines that the combination has the substance of an amalgamation rather than an acquisition (see paragraphs 8 to 14 of the Standard).
- BC15. The NZASB added guidance in paragraph 18 of the Standard to specify that in the first type of amalgamation, the resulting entity is a new reporting entity, and in the second type of amalgamation, the resulting entity is a continuing reporting entity.
- BC16. The NZASB decided not to base the requirements in the Standard on whether or not an entity is a new legal entity, because any new entities established as part of a PBE combination would not necessarily be separate legal entities.
- BC17. The clarification of these terms led to a number of other changes throughout the Standard including:
- (a) Clarifying that the resulting entity is a new reporting entity in paragraph 50;
  - (b) Clarifying that the resulting entity is a continuing reporting entity in paragraph 51; and
  - (c) The removal of paragraphs AG1 and AG22.

#### **Applying the Modified Pooling of Interests Method**

- BC18. The NZASB thought about application of the Standard to PBE combinations (in which the resulting entity could be either a continuing reporting entity or new reporting entity) where the combining operations have reported in accordance with different suites of standards. The NZASB thought that it was important for the Standard to be clear about what is required if (i) one of the combining entities had previously recognised assets and liabilities that did not meet the recognition and measurement requirements in PBE Standards; and/or (ii) one of the combining entities had failed to recognise assets and liabilities that should be recognised in accordance with PBE Standards. The NZASB also thought that the Standard needed to be clear about the circumstances in which the resulting entity would be expected to go through a first-time adoption process.
- BC19. The NZASB was of the view that IPSAS 40 does not contain sufficient guidance about these issues for New Zealand PBEs. For example, IPSAS 40 does not establish requirements about when the first-time adoption standard would be applied; this has been left to the judgement of the reporting entity. This guidance is particularly important in New Zealand because of our tiered Accounting Standards

Framework. The NZASB considered scenarios where the amalgamation involves combining operations that have been reporting under the Tier 3 or Tier 4 PBE Accounting Requirements. The NZASB therefore added guidance to address these situations (see paragraphs 20.1, AG50.1, AG50.2 of the Standard and paragraphs B6 to B9 of PBE FRS 47 *First-time Adoption of PBE Standards by Entities Other Than Those Previously Applying NZ IFRS*).

- BC20. The IPSASB did not permit the recognition of previously unrecognised assets/liabilities of the combining operations on the grounds that the IPSASB considered it would be costly for entities to identify, measure and recognise these assets/liabilities. The NZASB has previously established requirements for first-time adoption of PBE Standards and, as a consequence, the prohibition in IPSAS 40 on the recognition of previously unrecognised assets and liabilities had to be modified. This was necessary because application of PBE FRS 47 may result in the recognition of assets and liabilities as at the date of amalgamation that were not previously recognised by the first-time adopter. Hence, retaining the prohibition in IPSAS 40 would have created an inconsistency between PBE IPSAS 40 and PBE FRS 47. The NZASB therefore changed paragraph 21, omitted paragraph 23 and added paragraphs B6 to B9 of PBE FRS 47.

### Presentation of Financial Statements and Disclosures

- BC21. IPSAS 40 permits but does not require the resulting entity to present the combining operations' comparatives in the first set of financial statements following an amalgamation.
- BC22. The NZASB is of the view that the continuing reporting entity's comparatives are useful to readers and that a requirement to present such comparatives would not be onerous because the information would have already been prepared. The NZASB has therefore required that the continuing reporting entity present comparative information (see paragraph 51). The comparative information is not restated for the combining operations. This requirement has been clarified in paragraphs 51 and 52.
- BC23. The NZASB also clarified that a new reporting entity shall not present comparatives because it has not been in existence prior to the amalgamation (see paragraph 50).
- BC24. The NZASB considered what information should be presented in respect of amalgamations that occur part way through a reporting period. Generally, disestablished or newly established public sector entities are required to prepare financial statements following an amalgamation in accordance with legislative requirements (which are intended to ensure that users receive appropriate financial information up to, and following, the amalgamation). Other PBEs such as registered charities are not generally subject to equivalent legislative requirements. To address the potential information gap that could occur, the NZASB clarified that PBEs are required to provide historical information up to the date of the amalgamation (see paragraphs 52, 54(g) and 54(h)).

### Acquiring a Non-Cash-Generating Operation

- BC25. IPSAS 40 amended IPSAS 26 *Impairment of Cash-Generating Assets* to include requirements on impairment testing for goodwill acquired in an acquisition of a non-cash-generating operation. The amendments to IPSAS 26 required that, where goodwill is acquired in an acquisition of a non-cash-generating operation that results in a reduction in the net cash outflows of the acquirer, the acquirer (i.e. the entire reporting entity) is treated as a cash-generating unit for the purposes of impairment testing of goodwill. Paragraphs 90A and 90B of IPSAS 26 read as follows (emphasis added).

90A. For the purpose of impairment testing, goodwill acquired in an acquisition shall, from the acquisition date, be allocated to each of the acquirer's cash-generating units, or groups of cash-generating units, that is expected to benefit from the synergies of the combination, irrespective of whether other assets or liabilities of the acquired operation are assigned to those units or groups of units. **Where goodwill is acquired in an acquisition of a non-cash-generating operation that results in a reduction in the net cash outflows of the acquirer, the acquirer shall be considered as the cash-generating unit. Except where goodwill relates to the acquisition of a non-cash-generating operation,** each unit or group of units to which the goodwill is so allocated shall:

- (a) Represent the lowest level within the entity at which the goodwill is monitored for internal management purposes; and
- (b) Not be larger than a segment as defined by paragraph 9 of IPSAS 18, *Segment Reporting*.

- 90B. Goodwill recognized in an acquisition is an asset representing the future economic benefits arising from other assets acquired in an acquisition that are not individually identified and separately recognized. Goodwill does not generate cash flows, or reductions in net cash outflows, independently of other assets or groups of assets, and often contributes to the cash flows of multiple cash-generating units. Goodwill sometimes cannot be allocated on a non-arbitrary basis to individual cash-generating units, but only to groups of cash-generating units. As a result, the lowest level within the entity at which the goodwill is monitored for internal management purposes sometimes comprises a number of cash-generating units to which the goodwill relates, but to which it cannot be allocated. References in paragraphs 90D–90O and 97A–97H to a cash-generating unit to which goodwill is allocated should be read as references also to a group of cash-generating units to which goodwill is allocated. **Where goodwill is acquired in an acquisition of a non-cash-generating operation that results in a reduction in the net cash outflows of the acquirer, references in paragraphs 90D–90O and 97A–97H to a cash-generating unit to which goodwill is allocated should be read as references also to the acquirer.**
- BC26. The NZASB was of the view that, although goodwill could arise in an acquisition of a non-cash-generating operation, it is not appropriate to treat the acquirer as the cash-generating unit. This is because of concerns about the practical workability of the requirements for impairment testing the goodwill in accordance with IPSAS 26 when applied to the entire entity.
- BC27. To address these concerns, the NZASB considered that a practical solution would be to require that goodwill arising on the acquisition of a non-cash-generating operation be expensed in surplus or deficit at the acquisition date. The NZASB therefore omitted the IPSASB’s requirements in relation to goodwill arising from a non-cash-generating operation (from paragraphs 90A and 90B of PBE IPSAS 26) and amended paragraphs 86 and AG93 of PBE IPSAS 40 to require the recognition of the resulting loss in surplus or deficit if goodwill arises from the acquisition of a non-cash-generating operation. These changes led to further changes in paragraph 20A of PBE IPSAS 21 *Impairment of Non-Cash-Generating Assets* and paragraph 18A of PBE IPSAS 26.

### Identifying an Acquirer

- BC28. The NZASB noted that guidance from IFRS 3 (and PBE IFRS 3) on identifying an acquirer in a reverse acquisition was omitted from IPSAS 40 (see paragraphs B14–B18 of PBE IFRS 3). The IPSASB may have omitted this guidance from IPSAS 40 on the grounds that the exchange of equity instruments in the public sector is uncommon and is likely to occur only if there is a corporation involved. The NZASB acknowledged that PBE combinations are unlikely to involve reverse acquisitions and that guidance on identifying the acquirer in this situation is not required. However, the NZASB was of the view that it would be helpful to add guidance on whether one entity (and, if so, which entity) has gained control of another entity. The NZASB therefore added guidance from PBE IFRS 3 paragraph B15(c) and (d) in paragraphs AG14 and AG17.

### Transition

- BC29. IPSAS 40 requires prospective application. However, when providing guidance for first-time adopters of PBE Standards, the NZASB decided to permit retrospective application for prior amalgamations, consistent with the existing requirements in PBE FRS 47 for prior acquisitions, where retrospective application is permitted. Hence, the NZASB modified the transitional provisions to provide an exception for first-time adopters of PBE Standards — these are entities not previously applying New Zealand equivalents to International Financial Reporting Standards (NZ IFRS).
- BC30. The NZASB has therefore:
- (a) Retained the approach in IPSAS 40 of mandating prospective application, except for first-time adopters of PBE Standards to which PBE FRS 47 applies (see paragraph 134.1 of the Standard);
  - (b) Provided additional requirements in paragraph 134.2 to clarify that, as a consequence of mandating prospective application (except for first-time adopters of PBE Standards to which PBE FRS 47 applies), restatement of combinations that occurred before the effective date of the Standard is prohibited;
  - (c) Provided an exception for first-time adopters of PBE Standards to which PBE FRS 47 applies in paragraph 134.3 and guidance for first-time adopters of PBE Standards in PBE FRS 47;

- (d) Prohibited retrospective application for first-time adopters of PBE Standards to which PBE FRS 46 *First-time Adoption of PBE Standards by Entities Previously Applying NZ IFRS* applies. This is consistent with the general principle in PBE FRS 46 which restricts an entity changing its accounting policies previously used under NZ IFRS on first-time adoption of PBE Standards (see paragraph 29.1 of PBE FRS 46); and
- (e) Retained the approach in IPSAS 40 of permitting early application.

#### **Voluntary Combination not under Common Control**

BC31. IPSAS 40 does not provide guidance for voluntary combinations not under common control. These combinations are more common in the NFP sector than the public sector. The NZASB thought it would be helpful to add guidance and a related illustrative example for such combinations (see paragraph AG17.1 and scenario 15 in the illustrative examples).

#### **Selection of Accounting Policies by the Resulting Entity**

BC32. The NZASB was of the view that New Zealand PBEs required clear guidance on the selection of accounting policies by the resulting entity and the interaction between the Standard and PBE IPSAS 3 *Accounting Policies, Changes in Accounting Estimates and Errors*. The NZASB clarified the requirements in IPSAS 40, including making it clear that a continuing reporting entity would retain its prior accounting policies. The NZASB therefore added paragraphs AG54.1 and AG54.2 to provide guidance on the selection of accounting policies by a new reporting entity and a continuing reporting entity.

#### **Income Taxes**

BC33. IPSAS 40 includes some requirements on the recognition and measurement of income taxes following acquisitions and amalgamations and how to account for taxes forgiven as a result of a combination. Paragraphs 34, 79, AG58 and AG86 of IPSAS 40 read as follows.

34. The resulting entity shall recognize and measure any remaining taxation items included in or arising from an amalgamation in accordance with the relevant international or national accounting standard dealing with income taxes. The resulting entity shall recognize and measure any remaining revenue from taxation included in or arising from an amalgamation in accordance with IPSAS 23, *Revenue from Non-Exchange Transactions (Taxes and Transfers)*.

79. The acquirer shall recognize and measure any remaining taxation items included in or arising from an acquisition in accordance with the relevant international or national accounting standard dealing with income taxes. The acquirer entity shall recognize and measure any remaining revenue from taxation included in or arising from an acquisition in accordance with IPSAS 23.

AG58. Where, as a result of the amalgamation, the resulting entity becomes the tax authority, it shall derecognize any tax receivable relating to the combining operation's tax due that has been forgiven in accordance with IPSAS 23, *Revenue from Non-Exchange Transactions (Taxes and Transfers)*.

AG86. If the acquirer is itself the tax authority, it shall derecognize any tax receivable relating to the acquired operation's tax due that has been forgiven in accordance with IPSAS 23.

BC34. The NZASB was of the view that some of these requirements were not necessary and could create confusion. The NZASB therefore omitted paragraphs 34 and 79 and the related paragraphs AG58 and AG86.



## IPSASB Basis for Conclusions

*This Basis for Conclusions accompanies, but is not part of, IPSAS 40*

### Objective (paragraph 1)

- BC1. In the absence of an International Public Sector Accounting Standard (IPSAS) dealing with public sector combinations, public sector entities are directed, in IPSAS 1, *Presentation of Financial Statements*, to look to other international or national accounting standards. In the case of public sector combinations, they may look to International Financial Reporting Standard (IFRS®) 3, *Business Combinations*. However, IFRS 3 requires all business combinations to be accounted for using acquisition accounting. In developing IFRS 3, the International Accounting Standards Board (IASB®) came to the conclusion that ‘true mergers’ or ‘mergers of equals’ in which none of the combining entities obtains control of the others are so rare as to be virtually non-existent. The IASB also observed that respondents and other constituents were unable to suggest an unambiguous and non-arbitrary boundary for distinguishing true mergers or mergers of equals from other business combinations and concluded that developing such an operational boundary would not be feasible (see IFRS 3, BC35). Consequently, the IASB decided that separate accounting requirements for such combinations was not necessary.
- BC2. Many consider that in the public sector, mergers or amalgamations are the most common form of combination. As a result, public sector entities may not apply IFRS Standards when accounting for public sector combinations. This means that there may not be consistent or appropriate reporting of such combinations in general purpose financial statements (GPFs). Consequently, users may not be able to obtain the information needed to identify the type of public sector combination and evaluate its nature and financial effect. The IPSASB believes this Standard will promote consistency and comparability in how public sector combinations are reported by public sector entities.

### Process

- BC3. In developing this Standard the IPSASB had regard to the discussion of control in IPSAS 35, *Consolidated Financial Statements*. The IPSASB considered how control, as defined in IPSAS 35, should influence the classification of public sector combinations in this Standard. The IPSASB also had regard to the guidance on combinations in the *Government Finance Statistics Manual 2014* (GFSM 2014) with the aim of avoiding unnecessary differences. The IPSASB also considered IFRS 3 and guidance on combinations developed by national standard setters.

### *Alignment with Government Finance Statistics (GFS)*

- BC4. In developing this Standard, the IPSASB had regard to the treatment of public sector combinations in Government Finance Statistics (GFS):

GFS guidelines make a distinction between an acquisition and an amalgamation based on the principle that with an acquisition a transaction occurs, while with an amalgamation just a reclassification of units may occur.

A transaction will occur where a “market unit” is nationalized or privatized (that is, entering government control or leaving it), and the amounts are recorded in GFS as transactions in equity that correspond to the observed transaction price. Any changes in valuation—for example, between the opening balance of a government equity stake and the eventual transaction price—are recorded as revaluation effects, with no impact on government net lending/net borrowing. For amalgamations, the main impact is on the sectorization of the “institutional units”.

Where the units before amalgamation belonged to the same sector or subsector of general government, the amalgamation will have no impact on the data for that sector or subsector. For example, an amalgamation of two local governments, where both are already classified to the local government sector, would not change results for the local government sector.

However, in cases where a unit in one subsector is being amalgamated with a unit in another subsector, the amalgamated units will be removed from the sector they belonged to and be added to the sector of the new amalgamated unit, through a reclassification of the unit (recorded in GFS as an “other volume change in assets and liabilities”). For example, if a local government unit is amalgamated with a state

government, the unit will be reclassified from the local government subsector to the state government subsector.

- BC5. The IPSASB agreed the approach in GFS was not an appropriate basis for classifying public sector combinations in this Standard, for the following reasons:
- (a) The approach in GFS is based on a number of concepts that have no equivalent in IPSASs, for example:
    - (i) The classification of institutional units into sectors based on their economic nature; and
    - (ii) The distinction between market producers and nonmarket producers.
  - (b) Amalgamations in GFS can arise from a reclassification of units without a transaction being recorded, which is inconsistent with the approach in IPSASs; and
  - (c) Public sector combinations within the same sector or subsector of general government have no impact on the data in GFS, whereas IPSASs would require the changes to individual entities to be accounted for.
- BC6. In coming to this conclusion the IPSASB noted that the different approaches in GFS and IPSASs may lead to similar accounting, for example:
- (a) Nationalizations are likely to be recorded as acquisitions under both approaches; and
  - (b) The modified pooling of interests method of accounting will produce similar accounting to the GFS reclassification approach where the combining operations had previously adopted the same accounting policies.

#### Scope (paragraphs 2–4)

- BC7. The IPSASB initially considered developing two Standards on public sector combinations, covering:
- (a) Entity combinations arising from exchange transactions—a limited convergence project with IFRS 3; and
  - (b) Entity combinations arising from non-exchange transactions—a public sector-specific project.
- BC8. In May 2009, the IPSASB issued Exposure Draft (ED) 41, *Entity Combinations from Exchange Transactions*, which was the limited convergence project with IFRS 3. Following the consultation process on ED 41, the IPSASB decided not to continue with this approach for the following reasons:
- (a) IFRS 3 includes bargain purchases within its scope. It could be argued, therefore, that IFRS 3 also applies to at least some non-exchange entity combinations. The IPSASB acknowledged that it may be difficult to establish a clear demarcation between all exchange and non-exchange entity combinations.
  - (b) It was not clear whether combinations where no party gains control of the other parties to the combination would be classified as entity combinations arising from exchange transactions, and therefore required to be accounted for as an acquisition in accordance with ED 41.
- BC9. Subsequently, the IPSASB decided to develop a single standard dealing with all public sector combinations. This wider scope was included in the Consultation Paper (CP), *Public Sector Combinations*, issued in June 2012. Respondents to the CP supported this wider scope.
- BC10. The IPSASB, therefore, decided that this Standard should apply to all public sector combinations, with only limited exceptions. This Standard defines a public sector combination as the bringing together of separate operations into one public sector entity. This definition refers to the bringing together of operations rather than entities, as public sector combinations, in common with business combinations, may involve part of an entity that can be managed separately from the rest of the entity.
- BC11. In coming to a decision on the scope of this Standard, the IPSASB agreed to include public sector combinations under common control. While these are excluded from the scope of IFRS 3, the IPSASB considered it important that this Standard included all public sector combinations within its scope.

*Scope exclusions*

- BC12. The IPSASB agreed that this Standard should not apply to the formation of joint arrangements or joint ventures. The IPSASB stated in the CP that:
- “The concept underlying the formation of a joint venture differs from other combinations, in that the formation arises from separate entities deciding to share control, i.e., they have joint control of the operations that form the joint venture. The concept of joint control may give rise to issues that affect how the joint venture itself should account for its formation.”
- BC13. In developing this Standard, the IPSASB discussed whether this rationale was still valid given that this Standard takes a different approach to classifying public sector combinations. The IPSASB concluded that the concept of joint control does not reflect the issues addressed in this Standard, and agreed to exclude the formation of joint arrangements or joint ventures from its scope.
- BC14. The IPSASB noted that combinations of two or more joint arrangements may occur. The IPSASB considered that, where such a combination results in the formation of a new joint arrangement, this would be outside the scope of IPSAS 40. The IPSASB noted that a combination may result in the acquisition of one or more joint arrangements by another joint arrangement. In such circumstances, the entities that previously had control over the acquired joint arrangements give up that joint control. Such a combination would be an acquisition within the scope of IPSAS 40.
- BC15. The IPSASB also agreed to exclude from the scope of this Standard the acquisition by an investment entity of an investment in a controlled entity that is required to be measured at fair value through surplus or deficit. Such transactions are considered to be investments rather than public sector combinations. IPSAS 35 prescribes the accounting requirements for such transactions.

*Responses to ED 60, Public Sector Combinations*

- BC16. The IPSASB issued its proposals in ED 60, *Public Sector Combinations*, in January 2016. Respondents to ED 60 generally supported the proposed scope and the exclusions. The IPSASB considered the responses, and agreed that no changes to the scope were required. In doing so, the IPSASB noted that the scope of the standard included combinations undertaken on a temporary basis, for example the bailout of a private sector company with the intention of selling that company as soon as it was returned to a sound financial position. The IPSASB noted that including such combinations within the scope of this Standard was consistent with the decision taken in developing IPSAS 35 not to require a different accounting treatment for temporarily controlled entities.

**Classification of Public Sector Combinations (paragraphs 7–14)**

- BC17. As a result of the responses it received to ED 41, the IPSASB concluded that distinguishing between entity combinations arising from exchange transactions and entity combinations arising from non-exchange transactions did not provide a suitable basis for a future IPSAS. Relying on the definition of “exchange transactions” in the IPSASB’s literature would mean that most government interventions during times of economic crisis, such as the global financial crisis in 2008, would not meet the definition of an acquisition. The IPSASB considered it inappropriate to define such “bailouts” as amalgamations.
- BC18. The IPSASB also noted that IFRS 3 applied to a “business”, not to an entity. As well as applying to an entity, the definition of a business could also apply to part of an entity that could be managed separately from the rest of the entity. The IPSASB had regard to these issues in developing its approach in the CP.

*Classification approach in the Consultation Paper, Public Sector Combinations*

- BC19. The approach taken in the CP was to distinguish between combinations where the parties to the combination are under common control, and combinations where the parties to the combination are not controlled by the same ultimate controlling party, i.e., not under common control. A further distinction was made between combinations where one party gains control of another party (considered by the CP to be acquisitions), and combinations where no party gains control of the other parties to the combination (considered by the CP to be amalgamations).
- BC20. The IPSASB considered that the concept of control was important in determining the classification of a public sector combination. Control underpins much of financial reporting. IPSAS 35 requires an entity

to consolidate those other entities that it controls, as does the predecessor standard, IPSAS 6, *Consolidated and Separate Financial Statements*. The IPSASB also noted that Government Finance Statistics adopts a similar approach to control as that adopted in both IPSAS 35 and IPSAS 6.

BC21. Similarly, control is an important factor when recognizing assets. Paragraph 5.6 of the *Conceptual Framework for General Purpose Financial Reporting by Public Sector Entities* (the Conceptual Framework) defines an asset as “A resource presently controlled by the entity as a result of a past event.”

BC22. The IPSASB determined, therefore, that control was an appropriate starting point for the classification of public sector combinations. As a result, the CP included the IPSASB’s preliminary view as to the role of control in classifying public sector combinations:

“The sole definitive criterion for distinguishing an amalgamation from an acquisition is that, in an amalgamation, none of the combining operations gains control of the other operations.”

BC23. In developing the CP, the IPSASB explained that the parties to a public sector combination under common control are ultimately controlled by the same entity both before and after the combination. This leads to economic differences between combinations that take place under common control and those that take place not under common control, as follows:

- (a) Public sector combinations between entities within an economic entity (i.e., under common control) do not change the economic resources of that economic entity;
- (b) Any surpluses and deficits resulting from a public sector combination under common control are eliminated in full in the ultimate controlling entity’s consolidated GPFs; and
- (c) The ultimate controlling entity can specify whether any consideration is transferred (and if consideration is transferred, the amount of that consideration) in a public sector combination under common control.

These differences may have implications for the accounting treatment of a public sector combination under common control.

BC24. The approach in the CP reflected the IPSASB’s views that:

- (a) The economic differences between combinations that take place under common control and those that take place not under common control may have implications for their accounting treatment; and
- (b) Acquisitions should be distinguished from amalgamations on the basis of control.

BC25. Similar numbers of respondents to the CP supported and disagreed with the proposals. Respondents who disagreed with the proposals suggested that distinguishing acquisitions from amalgamations based solely on control did not reflect public sector circumstances. In particular, these respondents noted that

- (a) Public sector combinations may occur where it is not possible to identify an acquirer even if it is possible to identify an entity that has gained control of operations as a result of the public sector combination. Under IFRS 3, the acquirer can be identified by analyzing the ownership interests in the respective parties. However, in the public sector there may be no quantifiable ownership interests in the entities, making such an analysis impossible. The entity gaining control of the operations may not have existed prior to the combination, and if there are no quantifiable ownership interests in that entity, it will not be possible to identify an acquirer.
- (b) Public sector combinations may be imposed on all parties to the combination by a higher level of government, for example when a central government reorganizes local government by legislating the combination of municipalities irrespective of the wishes of those municipalities.

BC26. Respondents who disagreed with the proposals in the CP suggested a number of alternative bases for classifying public sector combinations, including:

- (a) Variations of whether consideration was transferred:
  - (i) Consideration was transferred as part of the combination;
  - (ii) Significant consideration was transferred as part of the combination;

- (iii) The combination was effected at market value;
  - (iv) Distinguishing acquisitions (which include the transfer of consideration) not under common control from all other combinations; and
  - (v) Distinguishing between combinations under common control on the basis of whether the combination has “commercial substance” (which includes the transfer of consideration).
- (b) Whether the public sector combination was effected voluntarily or involuntarily.

*Development of the classification approach in ED 60, Public Sector Combinations*

- BC27. The IPSASB considered the responses to the CP. The IPSASB accepted that the classification approach adopted in the CP would not always reflect public sector circumstances. Consequently, the IPSASB agreed to revisit the classification of public sector combinations.
- BC28. As part of this process, the IPSASB considered whether any of the approaches suggested by respondents might provide an alternative basis for classification. The IPSASB concluded that these approaches were not suitable, for the following reasons:
- (a) The IPSASB came to the view that the transfer of consideration, on its own, was insufficient to distinguish an acquisition from an amalgamation. As noted in paragraph BC17 above, defining an acquisition as an exchange transaction would lead to bailouts being classified as amalgamations. Similarly, if an acquisition was defined as requiring consideration to be transferred by the acquirer, this could lead to bailouts being classified as amalgamations. Definitions of an acquisition that required the transfer of significant consideration, or for the public sector combination to take place at market value, would not address issues such as bargain purchases (discussed above in paragraph BC8(a)).
  - (b) The IPSASB came to the view that whether a public sector combination was effected voluntarily or involuntarily did not provide, on its own, sufficient information to classify a public sector combination. The voluntary or involuntary nature of a public sector combination provides information as to the process of the combination but not its outcome. Public sector combinations may have different economic outcomes irrespective of their voluntary or involuntary nature. The IPSASB did not consider that it was possible to classify a public sector combination without considering the outcome of that combination. Consequently, the IPSASB did not consider a classification based solely on the voluntary or involuntary nature of the public sector combination would meet the objectives of financial reporting.
- BC29. The IPSASB reviewed the role of control in classifying public sector combinations, and concluded that control remained an important factor in determining whether a combination was an acquisition or an amalgamation. In coming to this conclusion, the IPSASB noted that an acquisition could only occur when a party to the combination gained control of one or more operations (this is discussed in more detail in paragraph BC25(a) above). Consequently, the IPSASB reviewed the factors suggested by respondents to the CP to determine which factors might usefully supplement the concept of control.
- BC30. The IPSASB discussed the following factors, and agreed that they could be helpful in supplementing the concept of control in classifying public sector combinations:
- (a) **Consideration.** The IPSASB agreed that whether a public sector combination includes the transfer of consideration is relevant to classifying the combination. Acquisitions generally include consideration, whereas consideration will be absent from amalgamations. For the reasons given in paragraph BC28(a) above, the IPSASB agreed that the transfer of consideration in itself was not conclusive, and that more information about the nature of a combination would be obtained by having regard to the reasons why consideration was or was not transferred.
  - (b) **Exchange transactions.** The IPSASB agreed that an acquisition was more likely to occur in an exchange transaction than in a non-exchange transaction. However, the IPSASB had already acknowledged that it may be difficult to establish a clear demarcation between all exchange and non-exchange entity combinations (see paragraph BC8(a) above). The IPSASB came to the conclusion that information about whether a public sector combination was an exchange transaction or a non-exchange transaction could be determined by having regard to the reasons why consideration was or was not transferred. Consequently, the IPSASB concluded that it is not necessary to assess this factor independently of consideration.

- (c) **Quantifiable ownership interests.** The IPSASB noted that whether there are quantifiable ownership interests in an operation can influence the economic substance of a public sector combination. If there are no quantifiable ownership interests in an operation, no consideration can be transferred as there is no party with an entitlement to receive the consideration. This can distinguish the combination from an acquisition, where there is always an owner to receive the consideration. The IPSASB noted that that lack of quantifiable ownership interests could be a reason why consideration was not transferred. Consequently, the IPSASB concluded that it is not necessary to assess this factor independently of consideration.
- (d) **Decision-making process.** The IPSASB agreed that having regard to which parties were able to make decisions regarding a public sector combination could provide useful information about the classification of that combination. In the private sector, combinations are usually entered into voluntarily, at least from the acquirer's perspective. In the public sector, other parties may be involved in the decision-making process. The freedom that the parties to the combination are able to exercise may influence the economic substance of the combination and hence its classification.
- (e) **Compulsion.** In the public sector, a public sector combination may be imposed by a higher level of government, whether or not that higher level of government controls the parties to the combination for financial reporting purposes. For example, a central government may restructure local government by directing certain municipalities to combine. The IPSASB agreed that compulsion was relevant to the classification of a public sector combination, but considered that information about compulsion would be obtained by having regard to decision-making. Consequently, the IPSASB concluded that it is not necessary to assess this factor independently of the decision-making process.
- (f) **Common control.** In developing the CP, the IPSASB identified the economic differences between public sector combinations that take place under common control and those that take place not under common control (see paragraph BC23 above). The IPSASB agreed that the ability of the controlling entity to specify whether any consideration is transferred is relevant to the classification of the combination, but considered this to be an element of the decision-making process. The fact that the economic resources of the economic entity do not change in a combination under common control, and that any surpluses or deficits would be eliminated on consolidation were seen as relevant to the controlling entity, but not the controlled entity. As the controlled entity will be the reporting entity for the combination, the IPSASB concluded that it is not necessary to assess this factor independently of the decision-making process.
- (g) **Citizens' rights.** In some jurisdictions, citizens may be part of the decision-making process, for example where public sector combinations are subject to the approval of citizens through a referendum. The IPSASB agreed that citizens' rights to accept or reject the combination was relevant to the classification of the combination. However, the IPSASB considered these rights to be rights to participate in the decision-making process. Consequently, the IPSASB concluded that it is not necessary to assess this factor independently of the decision-making process.
- BC31. The IPSASB did not consider that the following factors would be helpful in supplementing the concept of control in classifying public sector combinations:
- (a) **Change of sector.** The IPSASB acknowledged that a change of sector would be an indicator of a public sector entity acquiring an operation. However, the IPSASB considered that this change of sector would be a consequence of a change in control rather than a separate factor to be considered. The IPSASB also noted that the classification of institutional units into sectors based on their economic nature of being government units was a feature of GFS that had no equivalent in the IPSASB's literature. This will continue to be a significant difference between macroeconomic statistical reporting and accounting and financial reporting. Consequently, the IPSASB did not consider a change of sector to be a useful factor in classifying public sector combinations.
- (b) **Nature of the jurisdiction.** Some responses to the CP suggested that, in jurisdictions where there is significant interaction or redistribution between the different levels of government, the public sector can be seen as operating as part of a single quasi "group" entity. Such a view could have implications for the classification of public sector combinations. The IPSASB did not

consider that from the reporting entity's perspective, the nature of the jurisdiction was relevant to the classification of public sector combinations. A reporting entity could make an assessment of control, consideration and decision-making without reference to a quasi-group entity. The IPSASB noted that the nature of the jurisdiction may form part of the assessment of the nature of the public sector combination, which an entity may need to consider when the analysis of all other factors has produced inconclusive results or does not provide sufficient evidence to determine the appropriate classification of a public sector combination.

- (c) **Operation of government.** Some respondents to the CP suggested that the operation of government would be relevant to the classification of public sector combinations. Examples given included:
- (i) The existence of a ministerial or other government power enabling the government to direct the entity's governing body to achieve the government's policy objectives;
  - (ii) Ministerial approval is required for operating budgets; and
  - (iii) The government has broad discretion, under existing legislation, to appoint or remove a majority of the members of the governing body of the entity.

The IPSASB concluded that the examples were indicators of control or common control rather than suggesting an independent factor. As such, the IPSASB did not consider that the operation of government was relevant to the classification of public sector combinations.

- (d) **The entity directs public policy and/or engages in non-market activity mainly financed by public resources.** Some respondents to the CP suggested that control should be supplemented by having regard to whether the entity directs public policy and/or engages in non-market activity mainly financed by public resources. Where this was the case, this would suggest an amalgamation. The IPSASB noted that this approach would require the introduction of new concepts into the IPSASB's literature. For example, non-market activity is a GFS concept that the IPSASB has not adopted. The IPSASB did not consider it appropriate to introduce these concepts in ED 60. Consequently, the IPSASB did not consider that this factor was relevant to the classification of public sector combinations.
- (e) **Accountability.** Some respondents suggested that accounting for a public sector combination at fair value provides more information about the effect of that combination, but that this is only useful for accountability purposes where the entity was responsible for the decision to combine. The IPSASB did not consider accountability to be a primary factor in its own right, but acknowledged that the information resulting from the classification of a public sector combination should meet the objectives of financial reporting. In exceptional circumstances, when an analysis of consideration and the decision-making process produces an inconclusive result or does not provide sufficient evidence as to the appropriate classification of a public sector combination, an entity may need to consider other matters, including what information would meet the objectives of financial reporting and satisfy the qualitative characteristics (QCs).

BC32. The IPSASB concluded, therefore, that control should be supplemented by two additional factors—whether consideration was transferred, and the reasons for the presence or absence of consideration; and the decision-making process. These factors are wide ranging, and encompass elements of other factors, as discussed above.

BC33. The IPSASB noted that these factors could be used either to supplement the indicators of control in IPSAS 35, or could be used to supplement the control concept in classifying public sector combinations. The IPSASB debated the merits of these two approaches. The IPSASB noted that using the factors to supplement the indicators of control was likely to result in a classification approach that better satisfied the QC of comparability. However, the IPSASB considered that using the factors to supplement the control concept was likely to produce a classification approach that provided more relevant and faithfully representative information. Using the factors to supplement the control concept was also more likely to address the concerns raised by respondents.

BC34. Respondents to the CP had identified difficulties with distinguishing between acquisitions and amalgamations based solely on control that were unlikely to be fully addressed by further development of the indicators of control. The IPSASB agreed, and concluded that the gaining of control of operations by a party to the combination is an essential element of an acquisition, but is not sufficient in itself to

determine whether a combination is an acquisition. Consequently, the IPSASB agreed to develop an approach to classifying public sector combinations that:

- (a) Uses the factors to supplement the concept of control; and
- (b) Considers control in the context of whether a party to the combination gains control of one or more operations as a result of the combination.

BC35. Having agreed to develop an approach that uses the factors to supplement control, the IPSASB discussed the relative importance to be attached to control and to the other factors in classifying public sector combinations. As part of this discussion, the IPSASB identified the following two approaches:

- (a) **Rebuttable presumption approach.** Under this approach, when one party to the combination gains control of an operation, this creates a rebuttable presumption that the combination is an acquisition. This approach gives a strong weighting to the gaining of control, and the analysis of the other factors is focused on whether there is sufficient evidence to rebut this presumption.
- (b) **Individual weighting approach.** Under this approach, the weightings given to the gaining of control, consideration and decision-making are a matter for professional judgment based on the individual circumstances of the combination. Preparers would identify which (if any) factors indicate an acquisition and which (if any) factors indicate an amalgamation. Where indicators of both an acquisition and an amalgamation are present, the weighting given to the respective factors by preparers using professional judgment would determine the classification.

BC36. The IPSASB noted that the rebuttable presumption approach provided greater clarity, and better satisfied the QC of comparability. The individual weighting approach was likely to be more subjective in practice. However, the IPSASB acknowledged that the individual weighting approach would enable practitioners to better reflect the economic substance of the combination, and might better meet the QCs of relevance and faithful representation.

BC37. Control was seen by most members as more important in determining the classification than the other factors, and the rebuttable presumption approach reflected this. Consequently, the IPSASB agreed to develop the rebuttable presumption approach.

BC38. In coming to this decision the IPSASB noted that an approach that considered other factors as supplementing control (which better satisfies the QCs of relevance and faithful representation at the expense of comparability) while at the same time incorporating a rebuttable presumption that one party to a combination gaining control of operations gives rise to an acquisition (which better satisfies the QC of comparability at the expense of relevance and faithful representation) is likely to produce an appropriate balance between the QCs.

BC39. The IPSASB also considered the possibility that, in rare circumstances, neither the consideration nor the decision-making indicators would be sufficient to rebut the presumption that a public sector combination was an acquisition even though this classification did not reflect the economic substance of the combination. The IPSASB agreed to require consideration of the economic substance of the combination when determining whether the presumption should be rebutted. To assist preparers in this determination, ED 60 also required, in these rare circumstances, an assessment as to which classification produces information that best satisfies the objectives of financial reporting and the QCs.

BC40. The IPSASB considered that the most common circumstances in which a public sector combination would be considered an acquisition are:

- (a) One party to the combination gains control of an operation and pays consideration that is intended to compensate those with an entitlement to the net assets of the transferred operation for giving up that entitlement.
- (b) One party to the combination gains control of an operation from outside the public sector without paying consideration to compensate those with an entitlement to the net assets of the transferred operations.
- (c) One party to the combination gains control of an operation from outside the public sector by imposing the combination on the other party.
- (d) One party to the combination gains control of an operation from a separate government.



The IPSASB noted that, except in exceptional cases, the classification approach adopted in ED 60 would result in such combinations being classified as acquisitions. This provided reassurance to the IPSASB that the approach adopted was appropriate.

*Responses to ED 60*

- BC41. The IPSASB considered the responses to ED 60. The IPSASB noted that there was substantial support for the overall approach to classifying public sector combinations in the ED.
- BC42. Respondents did, however, identify areas where they considered the approach could be improved. The main issues identified were:
- (a) Having a rebuttable presumption that was expected to be rebutted significantly more frequently than not was confusing;
  - (b) The approach was seen as giving too much emphasis to control, with some stakeholders interpreting the ED as requiring the use of the acquisition method in most cases where one party to the combination gained control of operations; and
  - (c) In many jurisdictions, it will be easier to determine the economic substance of a public sector combination by reference to the indicators (consideration and decision making) than by reference to whether one party to the combination gained control of operations.
- BC43. The IPSASB acknowledged these concerns. The IPSASB accepted that rebuttable presumptions are generally expected to be rebutted infrequently, and that the use of this term with an expectation that it would be frequently rebutted may be confusing for preparers. This confusion could result in a preparer classifying a public sector combination as an acquisition when this was not the IPSASB's intention.
- BC44. The IPSASB considered that the potential confusion as to how the rebuttable presumption was to be interpreted might explain the concerns of some stakeholders that the acquisition method would be used inappropriately. The IPSASB did not intend that the approach in the ED would require the use of the acquisition method in most cases where one party to the combination gained control of operations. The IPSASB considered that acquisitions would arise in limited circumstances, as can be seen from the list in paragraph BC40 above.
- BC45. The IPSASB accepted that, in many jurisdictions, the economic substance of a public sector combination could be more readily determined by reference to the indicators, in particular whether a combination occurred under common control. However, the IPSASB noted that this was not the case for all jurisdictions. The IPSASB noted that control remained a significant factor; in particular, an acquisition can only occur when a party to the combination gains control of one or more operations. The IPSASB also noted that the approach in ED 60 provided a suitable decision framework for ensuring all relevant factors were considered.
- BC46. Consequently, the IPSASB agreed to reconsider the way the classification approach is expressed to address these concerns, without changing the substance of the approach. The rebuttable presumption and reference to control was intended to be the first step in the process of determining a classification based on the economic substance of the combination. In creating this first step, the IPSASB did not intend that, once it has been established that one party has gained control, control should be given greater weight than consideration and decision making in determining the economic substance of the combination. The IPSASB accepted that the reference in BC35(a) to the approach giving a strong weighting to the gaining of control could be misleading. Control remains important, as its absence eliminates the possibility of an acquisition, but its significance in determining the economic substance of a particular combination where one party has gained control is a matter of professional judgment. The IPSASB remains of the view that the classification approach in ED 60 was appropriate, and the changes introduced in this Standard are intended to provide greater clarity as to how the approach should be applied. These changes are not intended to produce different classifications from ED 60.

*Comparison with IFRS 3*

- BC47. This Standard is not converged with IFRS 3. IFRS 3 considers all business combinations to be acquisitions, whereas this Standard provides for both amalgamations and acquisitions. The IPSASB considers this difference to be appropriate, for the following reasons:

- (a) In developing IFRS 3, the IASB concluded that ‘true mergers’ or ‘mergers of equals’ in which none of the combining entities obtains control of the others are so rare as to be virtually non-existent. However, in the public sector, such combinations are common. Developing a Standard that did not address amalgamations would not meet the needs of the users of public sector GPFSs.
- (b) IFRS 3 assumes that it is always possible to identify the acquirer, as the businesses to which IFRS 3 applies will always have owners. In the public sector, there may be no quantifiable ownership interests in a public sector entity, which can make it impossible to identify an acquirer. Developing a Standard that does not recognize this situation would not meet the needs of the users of public sector GPFSs.

### **Accounting for Amalgamations (paragraphs 15–57)**

#### *Reasons for adopting the modified pooling of interests method of accounting for amalgamations*

- BC48. In developing the CP, the IPSASB identified three methods of accounting for public sector combinations that have either been applied in practice, or discussed. These are:
- (a) The acquisition method;
  - (b) The pooling of interests method, including a possible modification to this method; and
  - (c) The fresh start method.
- BC49. The acquisition method (which is applied by IFRS 3) requires that an acquirer is identified for all combinations. The IPSASB had already concluded that it may not be possible to identify an acquirer for all public sector combinations, and that any combination in which an acquirer could not be identified would be classified as an amalgamation. The IPSASB therefore concluded that the acquisition method of accounting would not be appropriate for amalgamations.
- BC50. The pooling of interests method of accounting was previously used in IAS 22, *Business Combinations* (the predecessor standard to IFRS 3). It was intended for application to a combination in which an acquirer cannot be identified. The pooling of interests method of accounting was previously used by many jurisdictions as the basis for merger accounting or amalgamation accounting. It continues to be used by many entities when accounting for combinations under common control (which are outside the scope of IFRS 3).
- BC51. The pooling of interests method accounts for the combining operations as though they were continuing as before, although now jointly owned and managed. The financial statement items of the combining operations for the period in which the combination occurs, and for any comparative periods disclosed, are included in the financial statements of the resulting entity as if they had been combined from the beginning of the earliest period presented. In other words, the recognition point is the beginning of the earliest period presented, and, consequently, comparative information is restated.
- BC52. The IPSASB noted that some are of the view that the requirement to restate comparative information might be onerous and unnecessary. In the CP, the IPSASB consulted on a variation of the pooling of interests method of accounting, described as the modified pooling of interests method of accounting. Under the modified pooling of interests method, the resulting entity combines the items in the statement of financial position as at the date of the amalgamation.
- BC53. The third method the IPSASB discussed in the CP was the fresh start method of accounting. In contrast to the pooling of interests method of accounting, the premise of the fresh start method is that the resulting entity is a new entity (irrespective of whether a new entity is formed) and therefore its history commences on that date. The modified pooling of interests method has a similar effect in practice.
- BC54. The fresh start method requires recognition of all of the identifiable assets and liabilities of all the combining operations at fair value as at the date of the combination in the financial statements of the resulting entity. This includes recognizing identifiable assets and liabilities that were not previously recognized by the combining operations. In other words, the fresh start method uses the same recognition and measurement basis as the acquisition method, but applies it to all of the combining operations rather than just acquired operations.

- BC55. In developing the CP, the IPSASB came to the conclusion that the pooling of interests method of accounting, the modified pooling of interests method of accounting and the fresh start method of accounting all provided a possible basis for accounting for amalgamations.
- BC56. The IPSASB noted that the future cash flows and service potential of the resulting entity will generally be the same regardless of which method is used to account for the amalgamation. However, the presentation of the financial performance and financial position of the resulting entity differs significantly depending on the method applied. If preparers are given a free choice of method, this would reduce comparability between entities and over time.
- BC57. Supporters of the pooling or modified pooling of interests method of accounting for amalgamations considered that these methods satisfy users' needs:
- (a) For information for decision-making purposes; and
  - (b) To assess the accountability of the resulting entity for its use of resources.
- This is because users of public sector entities' GPFSS use the information to assess how financial resources have been allocated and the financial condition of an entity. This information can be obtained by applying the pooling or modified pooling of interests methods of accounting.
- BC58. These methods are seen as satisfying the QCs of relevance and faithful representation, because they reflect the amounts recognized in the financial statements of the combining operations before the amalgamation. The subsequent performance of the resulting entity, and its accountability for the management of those resources, can be assessed on the same basis as was used to assess accountability before the amalgamation.
- BC59. The pooling or modified pooling of interests methods of accounting are seen as generally the least costly to apply, because they:
- (a) Use the existing carrying amounts of the assets, liabilities, and net assets/equity of the combining operations; and
  - (b) Do not require identifying, measuring, and recognizing assets or liabilities not previously recognized before the amalgamation.
- BC60. Supporters of the modified pooling of interests method of accounting consider it to be superior to the pooling of interests method because it portrays the amalgamation as it actually is. This is because it recognizes the assets and liabilities of the combining operations at the date of the amalgamation. Supporters consider this to be a faithful representation of the amalgamation.
- BC61. Those who support the use of the modified pooling of interests method acknowledge that the history of the combining operations may help in assessing the performance of the resulting entity. In debating the merits of the different methods, the IPSASB acknowledged that adopting the modified pooling of interests method of accounting without addressing users' needs for historical information may not satisfy the objectives of financial reporting.
- BC62. Others consider that the fresh start method of accounting is conceptually superior to both the pooling of interests method of accounting and its modified version, because the resulting entity is held accountable for the current value of the resources of the combining operations. It also provides more complete information of an amalgamation, because it recognizes the identifiable assets and liabilities of the combining operations, regardless of whether they were recognized prior to the amalgamation.
- BC63. Supporters of the fresh start method of accounting consider that it satisfies users' needs:
- (a) For information for decision-making purposes; and
  - (b) To assess the accountability of the resulting entity for its use of resources.
- This is because it enables users to better assess the financial condition of the entity and how the financial resources have been allocated.
- BC64. Supporters of the fresh start method of accounting consider that this method is, to a large extent, an extension of the use of fair value in the acquisition method of accounting. Consequently, they argue that if the acquisition method is adopted for acquisitions, there is no reason not to adopt similar accounting for amalgamations.

- BC65. In developing the CP, the IPSASB came to the view that the modified pooling of interests method of accounting is the appropriate method to apply, because users' are able to assess the performance and accountability of the resulting entity without the entity having to remeasure its assets and liabilities. Furthermore, it recognizes the amalgamation on the date it takes place. The IPSASB noted that IPSASs permit revaluation to fair value subsequent to initial recognition if a resulting entity considers that this approach would provide more relevant information to users.
- BC66. Respondents to the CP generally supported the IPSASB's view that the modified pooling of interests method of accounting is the appropriate method to apply to amalgamations. The IPSASB reconsidered the methods in developing ED 60, and identified no reason to change its previously stated view. The IPSASB therefore agreed that the modified pooling of interests method of accounting should be adopted for amalgamations in ED 60. In coming to this decision, the IPSASB agreed that the modified pooling of interests method of accounting should include appropriate disclosures to ensure that the users of public sector entities' GPFSs had access to the historical information they need.
- BC67. Respondents to ED 60 generally agreed that the modified pooling of interests method of accounting is the appropriate method to apply to amalgamations. However, some respondents considered that the pooling of interests method of accounting provided better information, and only supported the modified pooling of interests method for cost/benefit reasons. These respondents considered that, in some circumstances, the benefits of providing prior period information would outweigh the cost of so doing. The IPSASB accepted this view, and agreed that resulting entities should be permitted, but not required, to present prior period information. The IPSASB decided that prior period information should not be restated, as doing so would require the use of a different recognition point, which would reduce comparability.

*Exceptions to the principle that assets and liabilities are recognized and measured at their previous carrying amount*

- BC68. The modified pooling of interests method of accounting requires the resulting entity to recognize and measure the assets and liabilities of the combining operations at their previous carrying amounts, subject to the requirement to adjust the carrying amounts to conform to the resulting entity's accounting policies. The effects of all transactions between the combining operations, whether occurring before or after the amalgamation date, are eliminated in preparing the financial statements of the resulting entity.
- BC69. The IPSASB considered the circumstances in which the application of these principles would not be appropriate. The IPSASB identified three circumstances in which an exception to the recognition and/or measurement principles would be appropriate:
- (a) **Licenses and similar rights previously granted by one combining operation to another combining operation.** A license or similar right may have been granted by one combining operation to another combining operation and recognized as an intangible asset by the recipient. Applying the general principles would require this transaction to be eliminated. However, the IPSASB considered that, in granting the license or similar right, the recognition criteria for an intangible asset are met. Where internally generated intangible assets are not recognized, this is because of the problems in Identifying whether and when there is an identifiable asset that will generate expected future economic benefits or service potential; and in determining the cost of the asset reliably. Once a license or similar right has been granted to a recipient, this demonstrates that there is an identifiable asset that will generate future economic benefits or service potential. Similarly, the transaction will establish a cost for the asset. Consequently, the recognition criteria for an intangible asset are met. Because of this, the asset is not eliminated when combining operations that have granted and received the license or similar right are part of an amalgamation. The situation is similar to that where a tangible asset is sold by one combining operation to another combining operation. Eliminating the effect of the sale does not eliminate the tangible asset itself, as the asset was previously recognized by the seller. In the case of a license or similar right, eliminating the transaction does not eliminate the intangible asset, as the transaction provides sufficient evidence of the existence of the intangible asset, such that the grantor would itself recognize that intangible asset. The IPSASB noted that in some cases where a combining operation gains control of other operations, the right might be considered as a reacquired right. The IPSASB did not consider that this would warrant a different accounting treatment, and noted that reacquired rights are recognized as intangible

assets under the acquisition method. For these reasons, the IPSASB concluded that the asset recognized in respect of a license or similar right previously granted by one combining operation to another should not be eliminated.

- (b) **Income taxes.** In the public sector, amalgamations, especially those imposed by a higher level of government, may include tax forgiveness as part of the terms and conditions of the amalgamation. The IPSASB agreed that the resulting entity should recognize any tax items that exist following the amalgamation rather than those that existed prior to the amalgamation. Having considered comments by respondents to ED 60, the IPSASB agreed that there may be cases where any tax forgiveness arises subsequent to the amalgamation, rather than as part of the terms and conditions of the amalgamation. The IPSASB agreed to include provisions dealing with both cases in IPSAS 40.
- (c) **Employee benefits.** The IPSASB noted that the assets and liabilities required to be recognized by IPSAS 39, *Employee Benefits*, in respect of a post-employment benefit plan following an amalgamation might differ from the combined carrying amounts of the combining operations' equivalent amounts. As an example, an amalgamation involves five combining operations who are the only participants in a multi-employer defined benefit plan. Prior to the amalgamation, the combining operations have insufficient information to determine each combining operation's proportionate share of the defined benefit obligation, plan assets, and cost associated with the plan. As a result, the combining operations account for the plan as if it is a defined contribution plan. Following the amalgamation, the resulting entity is the only participant in the plan, and is able to determine its defined benefit obligation, plan assets, and cost associated with the plan. It therefore accounts for the plan as a defined benefit plan from the date of the amalgamation. The IPSASB agreed that the resulting entity's opening statement of financial position should include the assets and liabilities measured in accordance with IPSAS 39.

*Recognizing and measuring components of net assets/equity arising as a result of an amalgamation*

- BC70. In developing ED 60, the IPSASB noted that a residual amount might arise as a result of an amalgamation. The IPSASB considered how this should be recognized and measured. The IPSASB agreed that the residual amount does not reflect the financial performance of the resulting entity, and concluded that the residual amount should be recognized in the resulting entity's opening statement of financial position.
- BC71. The IPSASB considered the nature of the residual amount. The IPSASB considered that, for amalgamations not under common control, the residual amount represents the past financial performance of the combining operations not included in their transferred net assets/equity. The IPSASB agreed that the residual amount should be included in the resulting entity's opening net assets/equity where the amalgamation takes place not under common control.
- BC72. The IPSASB considered that, for amalgamations under common control, the residual amount represents the financial consequences of decisions made by the controlling entity in setting or accepting the terms of the amalgamation. Consequently, the IPSASB agreed that the residual amount should be treated as an ownership contribution or ownership distribution where the amalgamation takes place under common control.
- BC73. The IPSASB considered the items that should be included in the residual amount. The IPSASB noted that the modified pooling of interests method of accounting usually recognizes an amalgamation as giving rise to, in substance, a new entity on the date the amalgamation takes place. As the new entity would not have generated other components of net assets/equity such as accumulated surplus or deficit, or revaluation surplus, all items within net assets/equity would be included as part of the residual amount.
- BC74. The IPSASB considered that this approach best reflects the conceptual basis of an amalgamation and agreed that all items within net assets/equity at the amalgamation date should be considered to be part of the residual amount. In coming to this view, the IPSASB accepted that this approach may have consequences for some entities. For example, because the residual amount would include any previously recognized revaluation surplus, any future revaluation decreases are more likely to be recognized in surplus or deficit. This is because the previously recognized revaluation surplus would no longer be available to absorb future revaluation decreases.

BC75. Another consequence relates to amalgamations that take place under common control. The resulting entity would recognize a residual amount but the controlling entity would continue to recognize the previous components of net assets/equity in its consolidated financial statements, giving rise to ongoing consolidation adjustments. The IPSASB did not consider that these consequences outweighed the benefits of adopting the conceptual approach.

Responses to ED 60

BC76. Although the majority of respondents to ED 60 supported the IPSASB's approach to the residual amount, a significant minority did not. The main reasons respondents gave for not supporting the proposed treatment of the residual amount were as follows:

- (a) Retaining existing reserves better represents the combination, is more transparent and better meets users' needs;
- (b) The proposals will result in reliable information on the revaluation reserve being discarded;
- (c) For amalgamations under common control, the combining entities may effectively be continuing as one entity rather than as two or more separate entities, as opposed to being a new entity;
- (d) Reporting subsequent revaluation losses as an expense risks misrepresenting financial performance in future years;
- (e) The proposals will produce ongoing consolidation adjustments where the amalgamation takes place under common control, and the need to prepare these adjustments outweighed the benefits of recognizing a single residual amount; and
- (f) The proposals will impact on a wide range of reserves, including those relating to employee benefits, hedging and reserves restricted by legislation, which would be inconsistent with ED 60's requirement that the existing classifications and designations are maintained.

BC77. The IPSASB was persuaded by some of the reasons provided by respondents. In particular the IPSASB acknowledged that the proposals in ED 60 might be internally inconsistent.

BC78. The IPSASB therefore reconsidered the proposal to require all amounts recognized in net assets/equity to be recognized in the residual amount.

BC79. The IPSASB concluded that the most appropriate presentation of net assets/equity would depend on the circumstances of the amalgamation. In an amalgamation not under common control, and where there were no reserves such as those referred to in paragraph BC76(f) above, presenting a single opening balance in net assets/equity could provide faithfully representative information. In an amalgamation under common control, and with reserves such as those referred to in paragraph BC76(f) above, presenting a single opening balance in net assets/equity is unlikely to provide faithfully representative information. In these circumstances, presenting separate components of net assets/equity will provide more relevant and useful information.

BC80. Consequently, the IPSASB decided not to specify which components of net assets/equity should be presented, as preparers will be in the best position to judge the most appropriate treatment. The IPSASB agreed to amend the requirements accordingly.

*Measurement period*

BC81. IFRS 3 permits acquirers a period of one year after the acquisition date to complete the accounting for the acquisition. This is to allow the acquirer sufficient time to obtain information to determine the fair value of an acquired operation's assets and liabilities.

BC82. The IPSASB considered whether such a period was required when accounting for an amalgamation. The modified pooling of interests method does not require assets and liabilities to be restated to fair value at the amalgamation date. However, the IPSASB noted that the combining operations may have different accounting policies, which could result in some assets and liabilities being required to be restated to conform to the resulting entity's accounting policies. For example, the resulting entity may adopt an accounting policy of revaluing certain assets such as property, plant and equipment. If one or more combining operations had previously adopted an accounting policy of measuring such assets at cost, the practical effect of determining the carrying amount of those assets under the revaluation model would be similar to that of determining their fair value. For this reason, the IPSASB agreed that it was

appropriate to permit a resulting entity time to obtain the information needed to restate assets and liabilities to conform to its accounting policies. The IPSASB agreed that a period of one year was appropriate.

*Combining operations that have not previously adopted accrual basis IPSASs*

- BC83. In developing this Standard, the IPSASB considered whether it was necessary to include specific provisions to address the situation where one or more combining operations had not previously adopted accrual basis IPSASs. For example, one public sector entity that has previously applied accrual basis IPSASs may be amalgamated with a second public sector entity that has previously applied an alternative accrual basis of accounting. In such circumstances, recognizing and measuring the second public sector entity's assets and liabilities at their carrying amount may not be consistent with the requirements of accrual basis IPSASs.
- BC84. The IPSASB concluded that no separate provisions were required in this Standard. Paragraph 27 of IPSAS 40 requires the resulting entity to adjust the carrying amounts of the identifiable assets and liabilities of the combining operations where required to conform to the resulting entity's accounting policies. The IPSASB considered this requirement to be sufficient to address most circumstances where one or more combining operations had not previously adopted accrual basis IPSASs.
- BC85. The IPSASB came to the view that where adjusting the carrying amounts to conform to the resulting entity's accounting policies was insufficient to achieve compliance with accrual basis IPSASs, the resulting entity would be a first-time adopter of accrual basis IPSASs. This could occur where one or more combining operations had previously adopted the cash basis of accounting and had, therefore, not previously recognized certain assets and liabilities. In these circumstances, the resulting entity would apply IPSAS 33, *First-time Adoption of Accrual Basis International Public Sector Accounting Standards (IPSASs)* in preparing its first post-combination financial statements.

**Accounting for acquisitions (paragraphs 58–125)**

*Reasons for adopting the acquisition method of accounting for acquisitions*

- BC86. In developing the CP, the IPSASB did not reach a conclusion as to “whether the use of fair value as the measurement basis, is appropriate for some or all acquisitions in the public sector. This is because the most prevalent types of acquisition occur where operations are acquired for the achievement of objectives relating to the delivery of goods and/or services, instead of generating economic benefits to return to equity holders. Moreover, many acquisitions do not include the transfer of consideration. Some consider that these types of acquisitions are different in nature from business combinations as identified in IFRS 3, because the concept of acquiring an operation directly in exchange for the transfer of consideration is missing.” Respondents to the CP generally supported the use of fair value for acquisitions in which consideration was transferred. For acquisitions in which no consideration was transferred, there was broadly equal support for fair value measurement and measurement at carrying amount.
- BC87. The arguments developed in the CP reflected the classification approach in the CP. In the CP, the IPSASB proposed that the gaining of control was the sole definitive criterion for distinguishing an amalgamation from an acquisition. The IPSASB has subsequently decided to supplement the gaining of control with two other factors, consideration and decision-making. The IPSASB considers that this will result in fewer public sector combinations being classified as acquisitions than under the approach in the CP. Those public sector combinations that are classified as acquisitions will be similar in nature to the business combinations addressed by IFRS 3.
- BC88. Having regard to the revised classification approach that it had agreed to adopt, the IPSASB reconsidered which accounting method would be appropriate for acquisitions. The IPSASB concluded that the acquisition method was appropriate, and agreed to adopt the acquisition method as set out in IFRS 3 as the accounting method for acquisitions in this Standard. This approach was supported by respondents to ED 60.

*Differences to the accounting treatments in IFRS 3*

- BC89. IFRS 3 includes accounting treatments that are based on other IFRS Standards for which there is no equivalent IPSAS, for example income taxes and share-based payment. The IPSASB agreed not to

include the detailed requirements specified in IFRS 3, but to include references to the relevant international or national accounting standard dealing with the issue.

BC90. The IPSASB considered whether any additional guidance to that provided by IFRS 3 was required. The IPSASB noted that acquisitions in the public sector may include assets and liabilities arising from non-exchange transactions that are not addressed in IFRS 3. Consequently, the IPSASB agreed to include additional guidance on the following non-exchange items:

- (a) Tax forgiveness; and
- (b) The subsequent measurement of transfers, concessionary loans and similar benefits received by a combining operation on the basis of criteria that may change as a result of an acquisition.

BC91. The IPSASB considered comments from respondents to ED 60 regarding the acquisition method. As a result, the IPSASB agreed to make minor changes to the requirements:

The tax forgiveness requirements have been amended to allow for those cases where tax forgiveness occurs subsequent to the acquisition as well as where it forms part of the terms of the acquisition.

The IPSASB considered whether any additional exemptions to the recognition and measurement principles or any additional guidance on the acquisition method were required. The IPSASB concluded that no further provisions were necessary, as the Board considered that the provisions in this Standard or in other IPSASs were already sufficiently clear.

*Acquired operations that have not previously adopted accrual basis IPSASs*

BC92. In developing this Standard, the IPSASB considered whether it was necessary to include specific provisions to address the situation where one or more acquired operations had not previously adopted accrual basis IPSASs. The IPSASB concluded that no separate provisions were required in this Standard. Paragraph 64 of IPSAS 40 requires an acquirer to recognize the identifiable assets acquired, the liabilities assumed and any non-controlling interest in an acquired operation. Paragraph 72 of the Standard requires the acquirer to measure the assets and liabilities acquired at their acquisition-date fair values. Consequently, the acquirer will measure all assets and liabilities in accordance with accrual basis IPSASs, irrespective of the accounting basis previously adopted by an acquired operation.

*Fair value cannot be determined*

BC93. Respondents to ED 60 commented that, in exceptional circumstances, it may be impracticable for an acquirer to determine the fair value of an item and suggested that the use of the item's previous carrying amount may be an appropriate alternative. The IPSASB considered this suggestion but concluded that using carrying amount may not be appropriate in all instances, particularly if the acquired operation does not apply accrual based IPSASs. The IPSASB agreed that entities should apply the existing requirements in IPSASs. In particular, the IPSASB noted that, in accordance with IPSAS 3, *Accounting Policies, Changes in Accounting Estimates and Errors*, applying a requirement is impracticable when the entity cannot apply it after making every reasonable effort to do so. IPSAS 3 provides additional guidance. In such cases, the acquirer would measure the item as of the acquisition date in a manner that is consistent with other IPSASs and the acquirer's accounting policies, and make the disclosures required by other IPSASs. The IPSASB considered that it would be appropriate to measure the item at its previous carrying amount only where that carrying amount is consistent with other IPSASs and the acquirer's accounting policies.

**Revision of IPSAS 40 as a result of [draft] *Improvements to IPSAS, 2018*<sup>19</sup>**

BC94. The IPSASB reviewed the revisions to IFRS 3, *Business Combinations*, included in Annual Improvements to *IFRS® Standards 2015–2017 Cycle* issued by the IASB in December 2017, and the IASB's rationale for making these amendments as set out in its Basis for Conclusions. The IPSASB concurred that, as the accounting for an acquisition achieved in stages was the same in IPSAS 40 as in IFRS 3, there was no public sector specific reason for not adopting the amendments.

<sup>19</sup> In May 2018 the IPSASB issued *Improvements to IPSAS, 2018* which includes proposals to amend IPSAS 40 by adding paragraph 100A and to add paragraph BC94 to the IPSASB's Basis for Conclusions.



## Implementation Guidance

*This guidance accompanies, but is not part of, PBE IPSAS 40*

IG1. The purpose of this Implementation Guidance is to illustrate certain aspects of the requirements of PBE IPSAS 40.

### Classification of PBE Combinations

IG2. The diagram below summarises the process established by PBE IPSAS 40 for classifying PBE combinations.

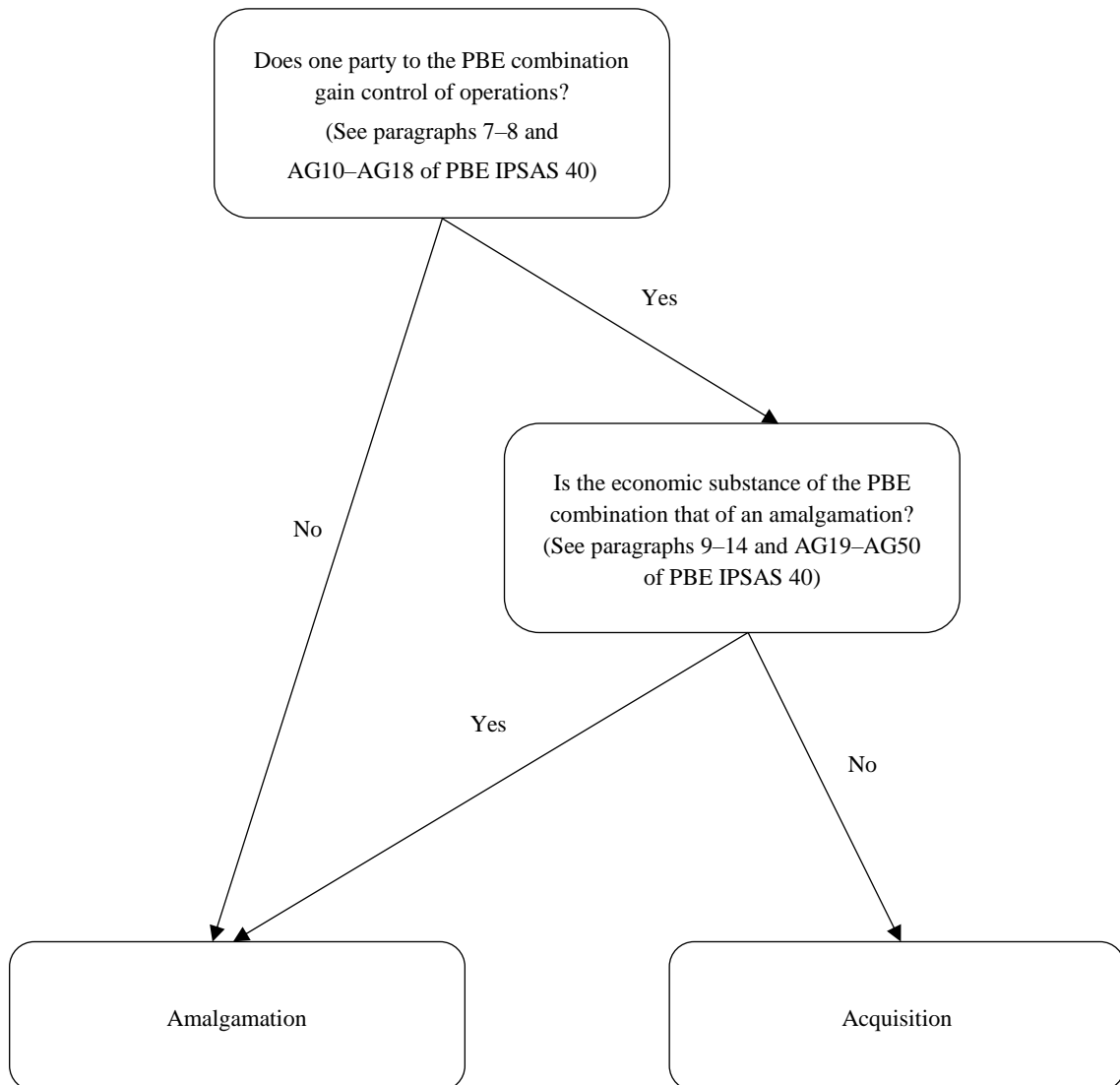

## Illustrative Examples

*These examples accompany, but are not part of, PBE IPSAS 40*

### Classification of PBE Combinations

*Illustrating the Consequences of Applying Paragraphs 7–14 and AG10–AG50 of PBE IPSAS 40*

- IE1. The following scenarios illustrate the process for classifying PBE combinations. These scenarios portray hypothetical situations. Although some aspects of the scenarios may be present in actual fact patterns, all facts and circumstances of a particular fact pattern would need to be evaluated when applying PBE IPSAS 40.
- IE2. Each scenario is illustrated by a diagram. Where a PBE combination involves operations which form part of an economic entity, but not the whole economic entity, the operations that are involved in the combination, and the entity that is formed by the combination, are shaded in the diagram. Where more than one reporting entity is included in an economic entity, the boundary of the economic entity is shown by a dotted line.

*Scenario 1: Reorganisation of Local Government by Rearranging Territorial Boundaries*

- IE3. The following diagram illustrates the creation of a new municipality by combining some operations from two existing municipalities.

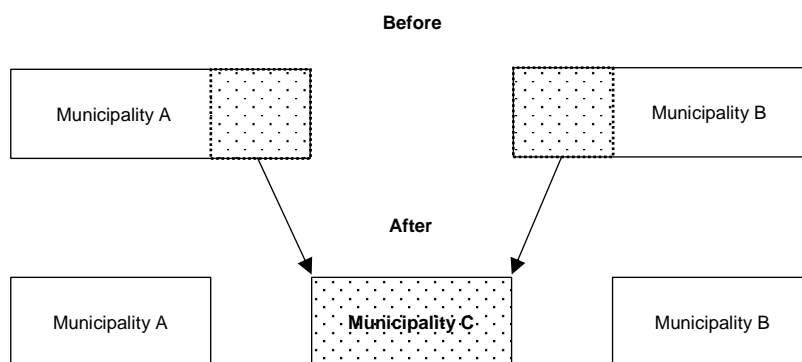

- IE4. In this scenario, the territorial boundaries of two existing municipalities, Municipality A and Municipality B, are redrawn by Parliament through legislation; neither Parliament nor Central Government controls Municipality A or Municipality B. Responsibility for part of each municipality's former territory is transferred to a new municipality, Municipality C. Operations in respect of the transferred territory are combined to form Municipality C. A PBE combination occurs.
- IE5. Municipality A and Municipality B remain otherwise unchanged and retain their governing bodies. A new governing body (unrelated to the governing bodies of Municipality A and Municipality B) is elected for Municipality C to manage the operations that are transferred from the other municipalities.
- IE6. The creation of Municipality C is a PBE combination. In determining whether this should be classified as an amalgamation or an acquisition, the first question to consider is whether one of the parties to the combination has gained control of operations as a result of the combination.
- IE7. Municipality C has a newly elected governing body, unrelated to the governing bodies of Municipality A and Municipality B. Neither Municipality A nor Municipality B has power over the Municipality C. Neither do they have exposure, or rights, to variable benefits from any involvement with Municipality C.
- IE8. Neither Municipality A nor Municipality B have gained control over Municipality C as a result of the PBE combination. Consequently the combination is classified as an amalgamation.

*Scenario 2: Reorganisation of Local Government by Combining Municipalities into a New Legal Entity*

IE9. The following diagram illustrates the creation of a new municipality by combining all of the operations of two existing municipalities into a new legal entity.

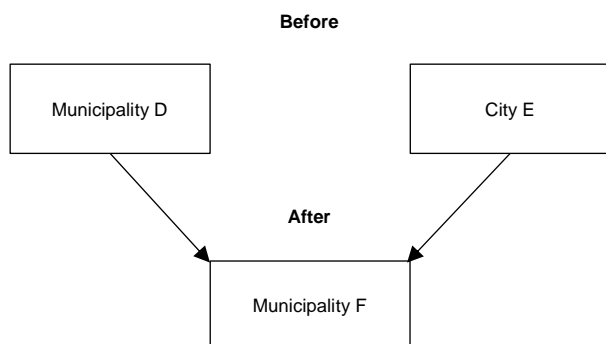

IE10. In this scenario, a PBE combination occurs in which Municipality F is formed to combine the operations (and the related assets, liabilities and components of net assets/equity) of Municipality D and City E. Prior to the combination, Municipality D and City E are not under common control. The combination is imposed by the provincial government (a third party) through legislation. The provincial government has the legal power to direct the two entities to combine, through legislation, even though it does not control them.

IE11. The legislation that creates Municipality F provides for the formation of a new governing body with no links to Municipality D or City E. Municipality D and City E have no role in determining the terms of the combination. After the combination, Municipality D and City E cease to exist.

IE12. The creation of Municipality F is a PBE combination. In determining whether this should be classified as an amalgamation or an acquisition, the first question to consider is whether one of the parties to the combination has gained control of operations as a result of the combination.

IE13. Municipality F has a newly formed governing body, unrelated to the governing bodies of Municipality D and City E. Neither Municipality D nor City E has power over Municipality F. Neither do they have exposure, or rights, to variable benefits from any involvement with Municipality F.

IE14. Neither Municipality D nor City E have gained control over Municipality F as a result of the PBE combination. Consequently the combination is classified as an amalgamation.

Scenario 2: Variation

IE15. In scenario 2, the legislation that creates Municipality F provides for the formation of a new governing body with no links to Municipality D or City E. In this variation, the legislation that creates Municipality F provides for the governing body of Municipality D to become the governing body of Municipality F.

IE16. This suggests that as part of the PBE combination that creates Municipality F, Municipality D is gaining control of the operations of City E. However, the assessment as to whether Municipality D is gaining control is based on the substance of the combination, not its legal form. In preparing its first financial statements, Municipality F considers the guidance in paragraphs 7–8 and AG10–AG18 of PBE IPSAS 40.

IE17. In this variation, it is assumed that the legislation that provides for the governing body of Municipality D to become the governing body of Municipality F results in Municipality D gaining:

- (a) Power over the operations of City E;
- (b) Exposure, or rights, to variable benefits from its involvement with those operations; and
- (c) The ability to use its power over those operations to affect the nature or amount of the benefits from its involvement with those operations.

IE18. Municipality F concludes that, as a result of the PBE combination, Municipality D has gained control of City E. Municipality F considers the guidance in paragraphs 9–14 and AG19–AG50 of

PBE IPSAS 40 in determining whether the economic substance of the combination is that of an amalgamation.

- IE19. [Not used]
- IE20. In considering the indicator relating to consideration, Municipality F notes that the PBE combination does not include the payment of consideration and the reasons for the absence of consideration do not provide evidence of an acquisition. This suggests that the economic substance of the combination is that of an amalgamation.
- IE21. In considering the indicators relating to the decision-making process, Municipality F notes that the PBE combination was imposed by the provincial government (a third party) and that Municipality D and City E had no role in determining the terms of the combination. This may suggest that the economic substance of the combination is that of an amalgamation.
- IE22. On balance these factors suggest that the PBE combination should be classified as an amalgamation.

*Scenario 3: Reorganisation of Local Government by Combining Municipalities into an Existing Legal Entity*

- IE23. The following diagram illustrates the combining of all of the operations of two existing municipalities into an existing legal entity.

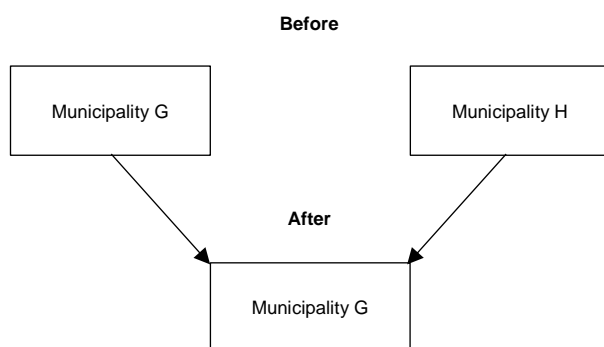

- IE24. In this scenario, a PBE combination occurs in which the operations of Municipality G and Municipality H (and their related assets, liabilities and components of net assets/equity) are combined into the legal entity of Municipality G. Prior to the combination, Municipality G and Municipality H are not under common control. The combination is imposed by Central Government (a third party) through legislation. Central Government has the legal power to direct the two entities to combine, through legislation, even though it does not control them.
- IE25. The legislation that effects the combination provides for the governing body of Municipality G to continue as the governing body of the combined entity. Municipality G and Municipality H have no role in determining the terms of the combination. After the PBE combination, Municipality H ceases to exist.
- IE26. These facts suggest that as part of the PBE combination, Municipality G is gaining control of the operations of Municipality H. However, the assessment as to whether Municipality G is gaining control is based on the substance of the combination, not its legal form. Municipality G considers the guidance in paragraphs 7–8 and AG10–AG18 of PBE IPSAS 40 in determining whether to classify the combination as an amalgamation or an acquisition.
- IE27. In this scenario, it is assumed that the legislation that provides for the governing body of Municipality G to continue as the governing body of combined entity results in Municipality G gaining:
- (a) Power over the operations of Municipality H;
  - (b) Exposure, or rights, to variable benefits from its involvement with those operations; and
  - (c) The ability to use its power over those operations to affect the nature or amount of the benefits from its involvement with those operations.
- IE28. Municipality G concludes that, as a result of the PBE combination, it has gained control of Municipality H. Municipality G considers the guidance in paragraphs 9–14 and AG19–AG50 of

PBE IPSAS 40 in determining whether the economic substance of the combination is that of an amalgamation.

- IE29. [Not used]
- IE30. In considering the indicator relating to consideration, Municipality G notes that the PBE combination does not include the payment of consideration and the reasons for the absence of consideration do not provide evidence of an acquisition. This suggests that the economic substance of the combination is that of an amalgamation.
- IE31. In considering the indicators relating to the decision-making process, Municipality G notes that the combination was imposed by Central Government (a third party) and that Municipality G and Municipality H had no role in determining the terms of the combination. This may suggest that the economic substance of the combination is that of an amalgamation.
- IE32. On balance these factors suggest that the PBE combination should be classified as an amalgamation.

*Scenario 3: Variation*

- IE33. In scenario 3, the legislation provides for the governing body of Municipality G to become the governing body of the combined entity. In this variation, the legislation provides for a new governing body to be formed that has no links to Municipality G or Municipality H.
- IE34. In determining whether this PBE combination should be classified as an amalgamation or an acquisition, the first question to consider is whether one of the parties to the combination has gained control of operations as a result of the combination.
- IE35. Despite its legal form continuing, Municipality G has a newly formed governing body, unrelated to its previous governing body or that of Municipality H. Consequently, the previous Municipality G does not gain power over Municipality H. Neither does it have exposure, or rights, to variable benefits from any involvement with Municipality H.
- IE36. Municipality G has not gained control over Municipality H as a result of the PBE combination. Consequently the combination is classified as an amalgamation.

*Scenario 4: Restructuring of Central Government Ministries*

- IE37. The following diagram illustrates the reorganisation of Central Government ministries by combining the Trade and Development Ministry and the Industry Ministry into the newly formed Trade and Industry Ministry.

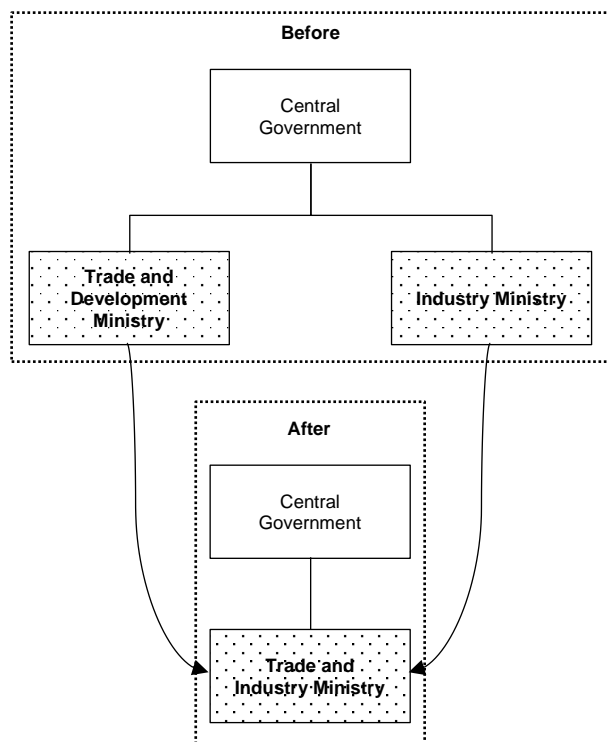

- IE38. In this scenario, a PBE combination occurs in which the Trade and Industry Ministry is formed to combine the operations (and the related assets, liabilities and components of net assets/equity) of the Trade and Development Ministry and the Industry Ministry. All the ministries, both prior to and after the combination, are controlled by Central Government. The combination is imposed by Central Government using this control. The Trade and Development Ministry and the Industry Ministry have no role in determining the terms of the combination.
- IE39. In effecting the combination, Central Government gives responsibility for the new Trade and Industry Ministry to the Minister of Industry and the governing body of the Industry Ministry. After the combination, the Trade and Development Ministry and the Industry Ministry cease to exist.
- IE40. As Central Government controls the same operations both before and after the PBE combination, Central Government does not report a combination in its consolidated financial statements. The combination is reported by the Trade and Industry Ministry.
- IE41. The creation of the Trade and Industry Ministry is a PBE combination. In determining whether this should be classified as an amalgamation or an acquisition, the first question to consider is whether one of the parties to the combination has gained control of operations as a result of the combination.
- IE42. Central Government gives responsibility for the new Trade and Industry Ministry to the Minister of Industry and the governing body of the Industry Ministry. This suggests that as part of the PBE combination that creates the new Trade and Industry Ministry, the Industry Ministry is gaining control of the operations of the Trade and Development Ministry. However, the assessment as to whether the Industry Ministry is gaining control is based on the substance of the combination, not its form. In determining whether the combination should be classified as an amalgamation or an acquisition, the Trade and Industry Ministry considers the guidance in paragraphs 7–8 and AG10–AG18 of PBE IPSAS 40.
- IE43. In this scenario, it is assumed that the decision of Central Government to give responsibility for the new Trade and Industry Ministry to the Minister of Industry and the governing body of the Industry Ministry results in the Industry Ministry gaining:
- Power over the operations of the Trade and Development Ministry;
  - Exposure, or rights, to variable benefits from its involvement with those operations; and

- (c) The ability to use its power over those operations to affect the nature or amount of the benefits from its involvement with those operations.
- IE44. The Trade and Industry Ministry concludes that, as a result of the PBE combination, the Industry Ministry has gained control of the Trade and Development Ministry. The Trade and Industry Ministry considers the guidance in paragraphs 9–14 and AG19–AG50 of PBE IPSAS 40 in determining whether the economic substance of the combination is that of an amalgamation.
- IE45. [Not used]
- IE46. In considering the indicator relating to consideration, the Trade and Industry Ministry notes that the PBE combination does not include the payment of consideration because the combination took place under common control, and Central Government, the controlling entity, did not specify any consideration in the terms of the combination. Although the absence of consideration (and the reasons for the absence of consideration) may suggest that the economic substance of the combination is that of an amalgamation, this is not of itself conclusive and other factors also need to be taken into account.
- IE47. In considering the indicators relating to the decision-making process, the Trade and Industry Ministry notes that the PBE combination takes place under common control. The combination was directed by Central Government and the Trade and Development Ministry and the Industry Ministry had no role in determining the terms of the combination. This provides evidence that the ultimate decision as to whether the combination took place, and the terms of the combination, are determined by the Central Government, the controlling entity. This provides evidence that the economic substance of the combination is that of an amalgamation.
- IE48. On balance these factors suggest that the PBE combination should be classified as an amalgamation. In coming to this decision, the fact that the PBE combination takes place under common control is considered to be the most significant factor in determining the economic substance of the combination.

#### Scenario 4: Variation

- IE49. In scenario 4, Central Government gives responsibility for the new Trade and Industry Ministry to the Minister of Industry and the governing body of the Industry Ministry. In this variation, Central Government appoints a new Minister and governing body.
- IE50. The creation of the Trade and Industry Ministry is a PBE combination under common control. In determining whether this should be classified as an amalgamation or an acquisition, the first question to consider is whether one of the parties to the combination has gained control of operations as a result of the combination.
- IE51. The Trade and Industry Ministry has a new Minister and a newly formed governing body, unrelated to the governing bodies of the Trade and Development Ministry and the Industry Ministry. Neither the Trade and Development Ministry or the Industry Ministry has gained power over the operations of the other ministry. Neither do they have exposure, or rights, to variable benefits from any involvement with the operations of the other ministry.
- IE52. Neither of the Trade and Development Ministry nor the Industry Ministry has gained control over the Trade and Industry Ministry as a result of the PBE combination. Consequently the combination is classified as an amalgamation.

*Scenario 5: Transfer of Operations under Common Control*

IE53. The following diagram illustrates the transfer of operations between two public sector entities that are under common control.

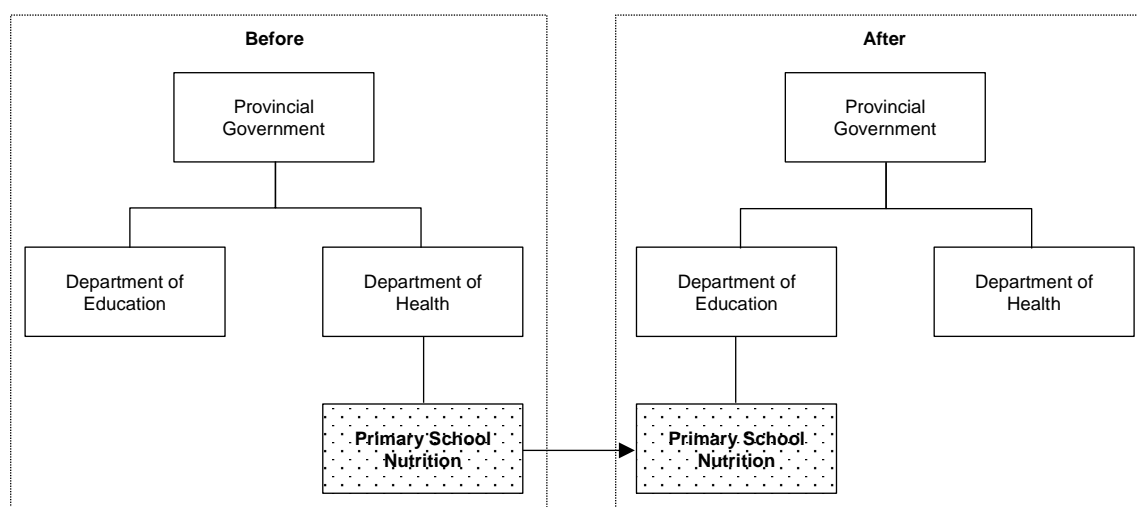

IE54. In this scenario, a PBE combination occurs in which the Primary School Nutrition operation is transferred from the Provincial Government’s Department of Health to its Department of Education. Both departments are controlled by the Provincial Government prior to and after the combination.

IE55. As the Provincial Government controls the same operations both before and after the PBE combination, the Provincial Government does not report a combination in its consolidated financial statements. The combination is reported by the Department of Education.

IE56. The transfer of the Primary School Nutrition operation is a PBE combination. In determining whether this should be classified as an amalgamation or an acquisition, the first question the Department of Education considers is whether one of the parties to the combination has gained control of operations as a result of the combination.

IE57. In this scenario, the Department of Education gains:

- (a) Power over the Primary School Nutrition operation;
- (b) Exposure, or rights, to variable benefits from its involvement with that operation; and
- (c) The ability to use its power over that operation to affect the nature or amount of the benefits from its involvement with that operation.

IE58. The Department of Education concludes that, as a result of the PBE combination, it has gained control of the Primary School Nutrition operation. The Department of Education considers the guidance in paragraphs 9–14 and AG19–AG50 of PBE IPSAS 40 in determining whether the economic substance of the combination is that of an amalgamation.

IE59. [Not used]

IE60. In considering the indicator relating to consideration, the Department of Education notes that the PBE combination does not include the payment of consideration because the combination took place under common control, and the Provincial Government, the controlling entity, did not specify any consideration in the terms of the combination. Although the absence of consideration (and the reasons for the absence of consideration) may suggest that the economic substance of the combination is that of an amalgamation, this is not of itself conclusive and other factors also need to be taken into account.

IE61. In considering the indicators relating to the decision-making process, the Department of Education notes that the PBE combination takes place under common control. The combination was directed by the Provincial Government. This provides evidence that the ultimate decision as to whether the combination took place, and the terms of the combination, are determined by the Provincial



Government, the controlling entity. This provides evidence that the economic substance of the combination is that of an amalgamation.

- IE62. On balance these factors suggest that the PBE combination should be classified as an amalgamation. In coming to this decision, the fact that the PBE combination takes place under common control is considered to be the most significant factor in determining the economic substance of the combination.

*Scenario 6: Combination of a Public Sector Entity with a Not-For-Profit Organisation*

- IE63. The following diagram illustrates the combination of a public sector entity with a not-for-profit organisation providing similar services.

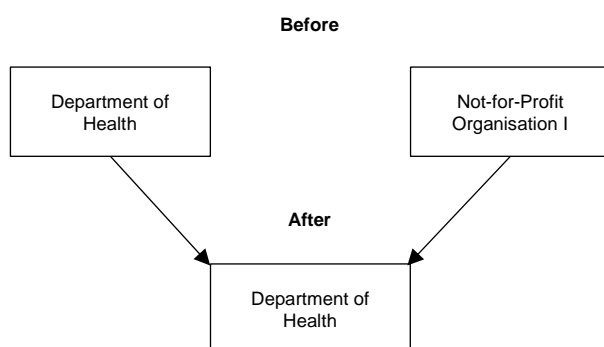

- IE64. In this scenario, a PBE combination occurs in which Not-for-Profit Organisation I, a charity which provides paramedic services, voluntarily agrees to combine with the Department of Health in order to improve the delivery of services to the public. The operations of Not-for-Profit Organisation I are integrated with similar operations provided by the Department of Health. Prior to the combination, the Department of Health has provided funding for Not-for-Profit Organisation I. The Department of Health meets the cost of transferring the title to the assets and liabilities of Not-for-Profit Organisation I incurred by the trustees of the charity.

- IE65. The combination of the Department of Health and Not-for-Profit Organisation I is a PBE combination. In determining whether this should be classified as an amalgamation or an acquisition, the first question the Department of Health considers is whether it has gained control of operations as a result of the combination.

- IE66. In this scenario, the Department of Health gains:

- (a) Power over Not-for-Profit Organisation I and its operations;
- (b) Exposure, or rights, to variable benefits from its involvement with those operations; and
- (c) The ability to use its power over those operations to affect the nature or amount of the benefits from its involvement with those operations.

- IE67. The Department of Health concludes that, as a result of the PBE combination, it has gained control of Not-for-Profit Organisation I. The Department of Health considers the guidance in paragraphs 9–14 and AG19–AG50 of PBE IPSAS 40 in determining whether the economic substance of the combination is that of an amalgamation.

- IE68. [Not used]

- IE69. In considering the indicator relating to consideration, the Department of Health notes that the PBE combination does not include the payment of consideration that is intended to compensate Not-for-Profit Organisation I for giving up its entitlement to its net assets. Although the Department of Health makes a payment to Not-for-Profit Organisation I, the payment is to compensate Not-for-Profit Organisation I for costs incurred in effecting the combination. Not-for-Profit Organisation I has voluntarily given up the rights to its net assets and donated them to the Department of Health because the Department of Health will provide an improved delivery of services to the public. This suggests that the economic substance of the combination is that of an acquisition.

IE70. In considering the indicators relating to the decision-making process, the Department of Health notes that the PBE combination was a voluntary combination. Consequently, these indicators do not provide any evidence to suggest that the economic substance of the combination is that of an amalgamation.

IE71. On balance these factors suggest that the PBE combination should be classified as an acquisition.

*Scenario 7: Transfer of an Operation between Levels of Government*

IE72. The following diagram illustrates the transfer of an operation between levels of government.

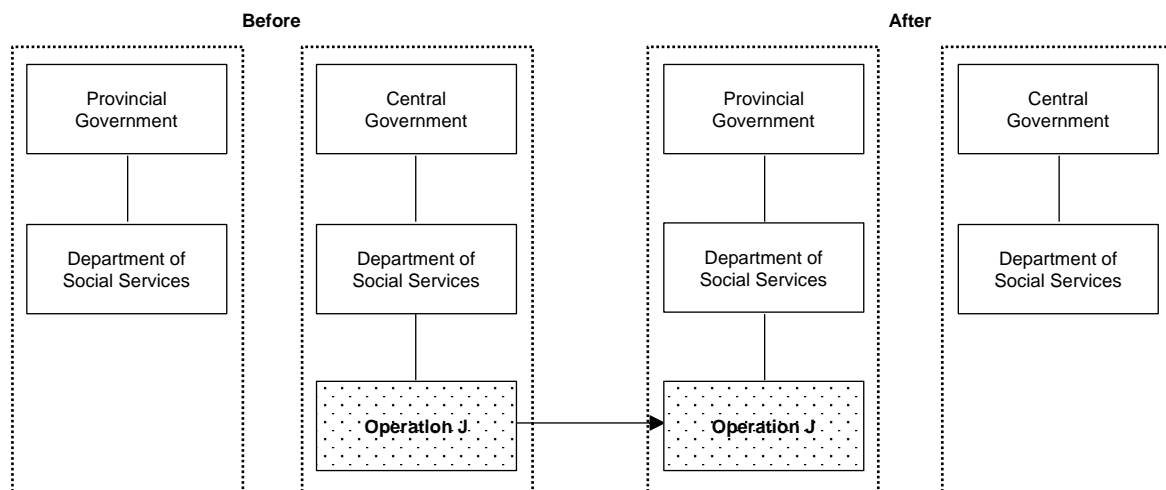

IE73. In this scenario, Central Government adopts a policy of devolving responsibility for some social services to the Provincial Government. Consequently, it proposes transferring Operation J, which provides residential care services, from Central Government's Department of Social Services to the Provincial Government's Department of Social Services. The Provincial Government supports the policy and agrees to accept Operation J. Operation J has net assets of CU1,000.<sup>20</sup> There is no transfer of consideration by the Provincial Government to the Central Government. However, the transfer agreement imposes an obligation on the Provincial Government to continue to provide the residential care services for a minimum of 10 years. Operation J does not recover all its costs from charges; the Provincial Government therefore assumes the responsibility for providing resources to meet the shortfall. Following the transfer, the Provincial Government operates Operation J as a stand-alone entity (i.e., there is a controlling entity/controlled entity relationship between the Provincial Government and Operation J), although it plans to integrate the operation with its other operations at a later date, which would remove the controlling entity/controlled entity relationship.

IE74. The transfer of Operation J is a PBE combination that will need to be reported in both the Provincial Government's financial statements and those of the Provincial Government's Department of Social Services. As the analysis required will be the same for both entities, this example uses the term Provincial Government to refer to both entities.

IE75. In determining whether this should be classified as an amalgamation or an acquisition, the first question the Provincial Government considers is whether it has gained control of operations as a result of the combination.

IE76. In this scenario, the Provincial Government gains:

- (a) Power over Operation J;
- (b) Exposure, or rights, to variable benefits from its involvement with Operation J; and
- (c) The ability to use its power over Operation J to affect the nature or amount of the benefits from its involvement with the operation.

<sup>20</sup> In these examples monetary amounts are denominated in 'currency units (CU)'.

- IE77. The Provincial Government concludes that, as a result of the PBE combination, it has gained control of Operation J. The Provincial Government considers the guidance in paragraphs 9–14 and AG19–AG50 of PBE IPSAS 40 in determining whether the economic substance of the combination is that of an amalgamation.
- IE78. In considering the economic substance of the PBE combination, the Provincial Government notes that the combination results in a controlling entity/controlled entity relationship between the Provincial Government and Operation J. This is inconsistent with the economic substance of an amalgamation.
- IE79. In considering the indicator relating to consideration, the Provincial Government notes that the PBE combination does not include the payment of consideration that is intended to compensate Central Government for giving up its entitlement to the net assets of an operation. However, the transfer agreement requires the Provincial Government to continue to provide the services. As Operation J does not recover all its costs from charges, the Provincial Government will need to provide the necessary resources to cover the shortfall. The Provincial Government considers that the cost of providing services for the agreed 10 year period is likely to be approximately equal to the value of the net assets received. It therefore considers that a market participant would estimate the fair value of Operation J (with the obligation to provide services for 10 years) to be zero. Although no consideration is transferred, this reflects the fair value of the combination. The Provincial Government concludes that, in this case the absence of consideration does not provide any evidence to suggest that the economic substance of the combination is that of an amalgamation.
- IE80. In considering the indicators relating to the decision-making process, the Provincial Government notes that the PBE combination is a voluntary combination. Consequently, these indicators do not provide any evidence to suggest that the economic substance of the combination is that of an amalgamation.
- IE81. Taking these factors together, the Provincial Government concludes that there is no evidence that the economic substance of the combination is that of an amalgamation, and that the PBE combination should, therefore, be classified as an acquisition.

#### Scenario 7: Variation

- IE82. In scenario 7, the Provincial Government considers that a market participant would estimate the fair value of Operation J (with the obligation to provide services for 10 years) to be zero. This is the reason that no consideration is paid. In this variation, Operation J is assumed to cover its costs from charges. Consequently, a market participant would estimate the fair value of Operation J (with the obligation to provide services for 10 years) to be greater than zero.
- IE83. In these circumstances, the fact that the combination does not include the payment of consideration that is intended to compensate Central Government for giving up its entitlement to the net assets of an operation may provide evidence that the economic substance of the combination is that of an amalgamation. However, the reasons for the absence of consideration need to be considered. There is nothing specific in the fact pattern about the reasons for the absence of consideration to support the classification as an amalgamation or an acquisition.
- IE84. In determining the classification of the PBE combination, the Provincial Government considers which factor or factors are the most significant. The Provincial Government considers the fact that it has gained control of Operation J and the fact that the combination does not involve the integration of its operations and those of Operation J to be the most significant factors in determining the economic substance of the combination. This suggests that the combination should be classified as an acquisition. The indicators relating to the decision-making process also support the classification as an acquisition. The Provincial Government therefore classifies the combination as an acquisition.

*Scenario 8: Transfer of a Commercial Entity between Levels of Government*

IE85. The following diagram illustrates the transfer of a commercial entity between levels of government.

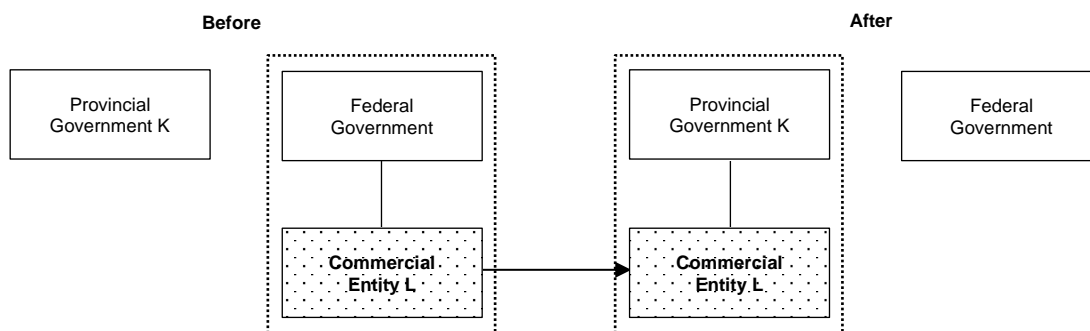

IE86. In this scenario, the Federal Government agrees to transfer Commercial Entity L to Provincial Government K. Provincial Government K pays consideration to the Federal Government in respect of the transfer. Following the combination, Provincial Government K operates Commercial Entity L as an arms-length, stand-alone entity.

IE87. The transfer of Commercial Entity L is a PBE combination. In determining whether this should be classified as an amalgamation or an acquisition, the first question Provincial Government K considers is whether it has gained control of operations as a result of the combination.

IE88. In this scenario, Provincial Government K gains:

- (a) Power over Commercial Entity L and its operations;
- (b) Exposure, or rights, to variable benefits from its involvement with those operations; and
- (c) The ability to use its power over those operations to affect the nature or amount of the benefits from its involvement with those operations.

IE89. Provincial Government K concludes that, as a result of the PBE combination, it has gained control of Commercial Entity L. Provincial Government K considers the guidance in paragraphs 9–14 and AG19–AG50 of PBE IPSAS 40 in determining whether the economic substance of the combination is that of an amalgamation.

IE90. In considering the economic substance of the PBE combination, Provincial Government K notes that the combination results in a controlling entity/controlled entity relationship between the Provincial Government and Commercial Entity L. This is inconsistent with the economic substance of an amalgamation. Provincial Government K also notes that the combination has commercial substance, which is suggestive of an acquisition.

IE91. In considering the indicator relating to consideration, Provincial Government K notes that the PBE combination includes the payment of consideration that is intended to compensate the seller for giving up its entitlement to the net assets of an operation. Provincial Government K concludes that the indicator relating to consideration does not provide any evidence to suggest that the economic substance of the combination is that of an amalgamation.

IE92. In considering the indicators relating to the decision-making process, Provincial Government K notes that the PBE combination is a voluntary combination. Consequently, these indicators do not provide any evidence to suggest that the economic substance of the combination is that of an amalgamation.

IE93. Taking these factors together, Provincial Government K concludes that there is no evidence that the economic substance of the combination is that of an amalgamation, and that the PBE combination should, therefore, be classified as an acquisition.

*Scenario 9: Purchase of a Private Sector Operation*

IE94. The following diagram illustrates the purchase of a private sector operation by a public sector entity.

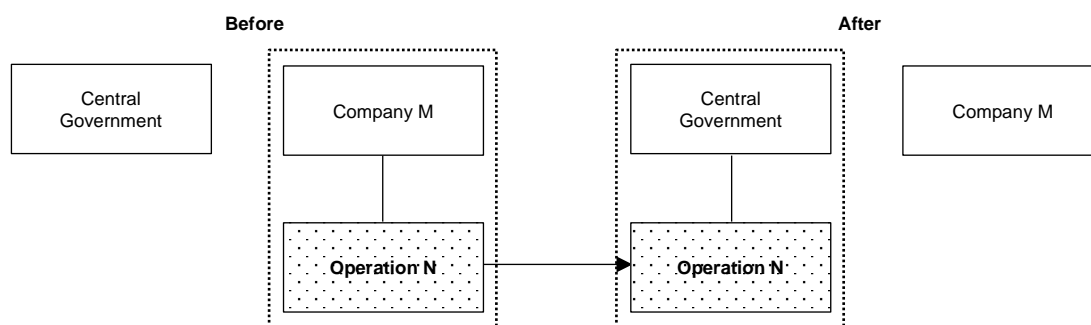

IE95. In this scenario, Central Government purchases Operation N from Company M. Central Government pays the market value of Operation N, and Company M acts voluntarily. Following the purchase, Operation N is managed as an arms-length, stand-alone entity.

IE96. The purchase of Operation N is a PBE combination. In determining whether this should be classified as an amalgamation or an acquisition, the first question Central Government considers is whether it has gained control of operations as a result of the combination.

IE97. In this scenario, Central Government gains:

- (a) Power over Operation N;
- (b) Exposure, or rights, to variable benefits from its involvement with Operation N; and
- (c) The ability to use its power over Operation N to affect the nature or amount of the benefits from its involvement with that operation.

IE98. Central Government concludes that, as a result of the PBE combination, it has gained control of Operation N. Central Government considers the guidance in paragraphs 9–14 and AG19–AG50 of PBE IPSAS 40 in determining whether the economic substance of the combination is that of an amalgamation.

IE99. In considering the economic substance of the PBE combination, Central Government notes that the combination results in a controlling entity/controlled entity relationship between Central Government and Operation N. This is inconsistent with the economic substance of an amalgamation. Central Government also notes that the combination has commercial substance, which is suggestive of an acquisition.

IE100. In considering the indicator relating to consideration, Central Government notes that the PBE combination includes the payment of consideration that is intended to compensate the seller for giving up its entitlement to the net assets of an operation. Central Government concludes that the indicator relating to consideration does not provide any evidence to suggest that the economic substance of the combination is that of an amalgamation.

IE101. In considering the indicators relating to the decision-making process, Central Government notes that the PBE combination is a voluntary combination. Consequently, these indicators do not provide any evidence to suggest that the economic substance of the combination is that of an amalgamation.

IE102. Taking these factors together, Central Government concludes that there is no evidence that the economic substance of the combination is that of an amalgamation, and that the PBE combination should, therefore, be classified as an acquisition.

**Scenario 9: Variation**

IE103. In scenario 9, Company M enters into the transaction voluntarily. In this variation, Central Government nationalises Operation N through a compulsory purchase. The purchase is still effected at the market value of Operation N.

- IE104. The change from a voluntary transaction to a compulsory purchase does not affect the assessments of control or the indicator related to consideration.
- IE105. In considering the indicators relating to the decision-making process, Central Government notes that Company M does not act voluntarily. The fact that Central Government (a party to the combination) is able to impose the PBE combination on Company M provides evidence that the economic substance of the combination is that of an acquisition.
- IE106. Consequently, Central Government classifies the PBE combination as an acquisition.

*Scenario 10: Bargain Purchase*

- IE107. The following diagram illustrates a bargain purchase by a public sector entity.

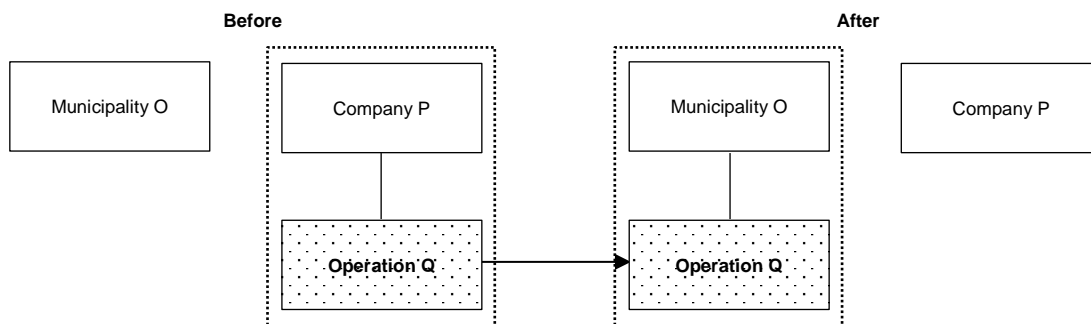

- IE108. In this scenario, Municipality O purchases Operation Q from Company P in a bargain purchase. Company P is seeking to sell Operation Q quickly to release cash for its other operations, and is willing to accept a price below the market value of Operation Q for an early sale. In entering into the bargain purchase, Company P acts voluntarily. Following the purchase, Operation Q is managed as an arms-length, stand-alone entity by Municipality O.
- IE109. The bargain purchase of Operation Q is a PBE combination. In determining whether this should be classified as an amalgamation or an acquisition, the first question Municipality O considers is whether it has gained control of operations as a result of the combination.
- IE110. In this scenario, Municipality O gains:
- Power over Operation Q;
  - Exposure, or rights, to variable benefits from its involvement with Operation Q; and
  - The ability to use its power over Operation Q to affect the nature or amount of the benefits from its involvement with that operation.
- IE111. Municipality O concludes that, as a result of the PBE combination, it has gained control of Operation Q. Municipality O considers the guidance in paragraphs 9–14 and AG19–AG50 of PBE IPSAS 40 in determining whether the economic substance of the combination is that of an amalgamation.
- IE112. In considering the economic substance of the PBE combination, Municipality O notes that the combination results in a controlling entity/controlled entity relationship between Municipality O and Operation Q. This is inconsistent with the economic substance of an amalgamation. Municipality O also notes that the combination has commercial substance (even though the price paid was below the market price of Operation Q), which is suggestive of an acquisition.
- IE113. In considering the indicator relating to consideration, Municipality O notes that the PBE combination includes the payment of consideration that is intended to compensate the seller for giving up its entitlement to the net assets of an operation, even though that price was below market value. Company P voluntarily accepted a lower price for a quick sale, and the purpose of the consideration paid was to provide Company P with the level of compensation for giving up its entitlement to the net assets of Operation Q that it was willing to accept. Municipality O concludes that the indicator relating to consideration does not provide any evidence to suggest that the economic substance of the combination is that of an amalgamation.

- IE114. In considering the indicators relating to the decision-making process, Municipality O notes that the PBE combination is a voluntary combination. Consequently, these indicators do not provide any evidence to suggest that the economic substance of the combination is that of an amalgamation.
- IE115. Taking these factors together, Municipality O concludes that there is no evidence that the economic substance of the combination is that of an amalgamation, and that the PBE combination should, therefore, be classified as an acquisition.

Scenario 10: Variation

- IE116. In scenario 10, Company P enters into the transaction voluntarily. In this variation, Municipality O seizes Operation Q through a compulsory purchase. The purchase is still effected at a price below the market value of Operation Q. Company P would not have sold Operation Q for a price below market value voluntarily.
- IE117. The change from a voluntary transaction to a compulsory purchase does not affect the assessment of control.
- IE118. In considering the indicator relating to consideration, Municipality O notes that the PBE combination includes consideration that is intended to compensate the seller for giving up its entitlement to the net assets of an operation. However, the level of compensation is less than Company P would have accepted voluntarily. Consequently, this indicator provides only weak evidence that the economic substance of the combination is that of an acquisition, and greater reliance is placed on other factors.
- IE119. In considering the indicators relating to the decision-making process, Municipality O notes that Company P does not act voluntarily. The fact that Municipality O (a party to the combination) is able to impose the PBE combination on Company P provides evidence that the economic substance of the combination is that of an acquisition.
- IE120. Taking all the factors into account, Municipality O classifies the PBE combination as an acquisition.

Scenario 11: Donated Operations

- IE121. The following diagram illustrates the receipt of a donated operation by a public sector entity.

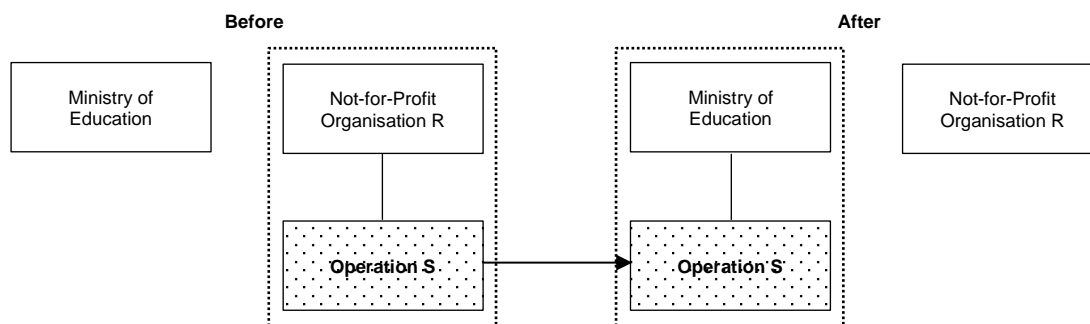

- IE122. In this scenario, Not-for-Profit Organisation R, a charity providing education services, voluntarily transfers Operation S, a school, to the Ministry of Education at no cost. Not-for-Profit Organisation R does this because it considers that this will result in improved services to the public, and enable it to meet its objectives.
- IE123. The donation of Operation S is a PBE combination. In determining whether this should be classified as an amalgamation or an acquisition, the first question the Ministry of Education considers is whether it has gained control of operations as a result of the combination.
- IE124. In this scenario, the Ministry of Education gains:
- Power over Operation S;
  - Exposure, or rights, to variable benefits from its involvement with Operation S; and
  - The ability to use its power over Operation S to affect the nature or amount of the benefits from its involvement with that operation.

- IE125. The Ministry of Education concludes that, as a result of the PBE combination, it has gained control of Operation S. The Ministry of Education considers the guidance in paragraphs 9–14 and AG19–AG50 of PBE IPSAS 40 in determining whether the economic substance of the combination is that of an amalgamation.
- IE126. In considering the economic substance of the PBE combination, the Ministry of Education notes that the combination has commercial substance (even though no price was paid for Operation S), which is suggestive of an acquisition.
- IE127. In considering the indicator relating to consideration, the Ministry of Education notes that the PBE combination does not include the payment of consideration that is intended to compensate Not-for-Profit Organisation R for giving up its entitlement to its net assets. However, the reason for this is that Not-for-Profit Organisation R voluntarily surrendered those rights. The situation is similar to that of a bargain purchase. In a bargain purchase, a seller may be willing to accept a price below market value where this meets its needs, for example in enabling a quick sale. With a donated operation, the former owner is willing to transfer the operation for no consideration to its preferred counterparty. In this scenario, Not-for-Profit Organisation R is willing to transfer Operation S to the Ministry of Education because this will provide improved services to the public. Consequently, the Ministry of Education concludes that the indicator of consideration does not provide any evidence to suggest that the economic substance of the combination is that of an amalgamation.
- IE128. In considering the indicators relating to the decision-making process, the Ministry of Education notes that the PBE combination is a voluntary combination. Consequently, these indicators do not provide any evidence to suggest that the economic substance of the combination is that of an amalgamation.
- IE129. Taking these factors together, the Ministry of Education concludes that there is no evidence that the economic substance of the combination is that of an amalgamation, and that the PBE combination should, therefore, be classified as an acquisition.

*Scenario 12: Nationalisation of a Private Sector Entity–Forced Seizure*

- IE130. The following diagram illustrates the nationalisation of a private sector entity by a public sector entity by means of a forced seizure.

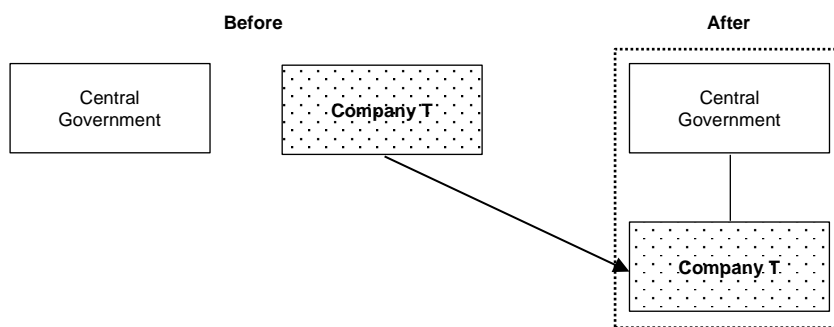

- IE131. In this scenario, Central Government nationalises Company T through legislation. Central Government does not pay any consideration to the shareholders of Company T. Following the purchase, Company T is managed as an arms-length, stand-alone entity.
- IE132. The nationalisation of Company T is a PBE combination. In determining whether this should be classified as an amalgamation or an acquisition, the first question Central Government considers is whether it has gained control of operations as a result of the combination.
- IE133. In this scenario, Central Government gains:
- Power over Company T;
  - Exposure, or rights, to variable benefits from its involvement with Company T; and
  - The ability to use its power over Company T to affect the nature or amount of the benefits from its involvement with Company T.



- IE134. Central Government concludes that, as a result of the PBE combination, it has gained control of Company T. Central Government considers the guidance in paragraphs 9–14 and AG19–AG50 of PBE IPSAS 40 in determining whether the economic substance of the combination is that of an amalgamation.
- IE135. In considering the economic substance of the PBE combination, Central Government notes that the combination results in a controlling entity/controlled entity relationship between Central Government and Company T. This is inconsistent with the economic substance of an amalgamation. Central Government also notes that, by depriving the former shareholders of their rights to Company T, the combination has commercial substance, which is suggestive of an acquisition.
- IE136. In considering the indicator relating to consideration, Central Government notes that the PBE combination does not include the payment of consideration that is intended to compensate the former shareholders of Company T for giving up their entitlements to the net assets of an operation. However, the former shareholders of Company T have had their entitlements extinguished through compulsion, which provides evidence that the economic substance of the combination is that of an acquisition. Central Government concludes that the indicator relating to consideration does not provide any evidence to suggest that the economic substance of the combination is that of an amalgamation.
- IE137. In considering the indicators relating to the decision-making process, Central Government notes that Company T does not act voluntarily. The fact that Central Government (a party to the combination) is able to impose the combination on Company T provides evidence that the economic substance of the combination is that of an acquisition.
- IE138. Taking these factors together, Central Government concludes that there is no evidence that the economic substance of the combination is that of an amalgamation, and that the PBE combination should, therefore, be classified as an acquisition.

*Scenario 13: Nationalisation of a Private Sector Entity–Bailout*

- IE139. The following diagram illustrates the nationalisation of a private sector entity by a public sector entity by means of a bailout.

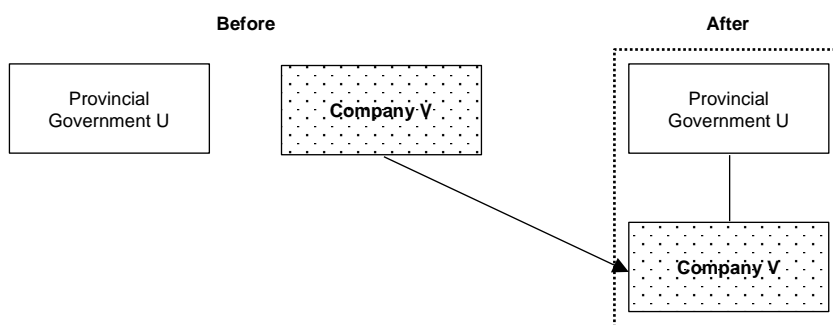

- IE140. In this scenario, Provincial Government U nationalises Company V through legislation as a result of a bailout. Prior to the nationalisation, Company V was in financial distress. Provincial Government U does not pay any consideration to the shareholders of Company V but does assume Company V’s net liabilities. Following the purchase, Company V is managed as an arms-length, stand-alone entity.
- IE141. The nationalisation of Company V is a PBE combination. In determining whether this should be classified as an amalgamation or an acquisition, the first question Provincial Government U considers is whether it has gained control of operations as a result of the combination.
- IE142. In this scenario, Provincial Government U gains:
- (a) Power over Company V;
  - (b) Exposure, or rights, to variable benefits from its involvement with Company V; and
  - (c) The ability to use its power over Company V to affect the nature or amount of the benefits from its involvement with Company V.

- IE143. Provincial Government U concludes that, as a result of the PBE combination, it has gained control of Company V. Provincial Government U considers the guidance in paragraphs 9–14 and AG19–AG50 of PBE IPSAS 40 in determining whether the economic substance of the combination is that of an amalgamation.
- IE144. In considering the economic substance of the PBE combination, Provincial Government U notes that the combination results in a controlling entity/controlled entity relationship between Provincial Government U and Company V. This is inconsistent with the economic substance of an amalgamation. Provincial Government U also notes that, by assuming the net liabilities of Company V, the combination has commercial substance, which is suggestive of an acquisition.
- IE145. In considering the indicator relating to consideration, Provincial Government U notes that the PBE combination does not include the payment of consideration. However, Company V has net liabilities that are assumed by Provincial Government U as part of the combination. The lack of consideration reflects the fair value of Company V rather than suggesting that the economic substance of the combination is that of an amalgamation. Provincial Government U concludes that the indicator relating to consideration does not provide any evidence to suggest that the economic substance of the combination is that of an amalgamation.
- IE146. In considering the indicators relating to the decision-making process, Provincial Government U notes that Company V does not act voluntarily. The fact that Provincial Government U (a party to the combination) is able to impose the PBE combination on Company V provides evidence that the economic substance of the combination is that of an acquisition.
- IE147. Taking these factors together, Provincial Government U concludes that there is no evidence that the economic substance of the combination is that of an amalgamation, and that the PBE combination should, therefore, be classified as an acquisition.

*Scenario 14: Nationalisation of a Not-For-Profit Organisation–Bailout*

- IE148. The following diagram illustrates the nationalisation of a not-for-profit organisation by a public sector entity by means of a bailout.

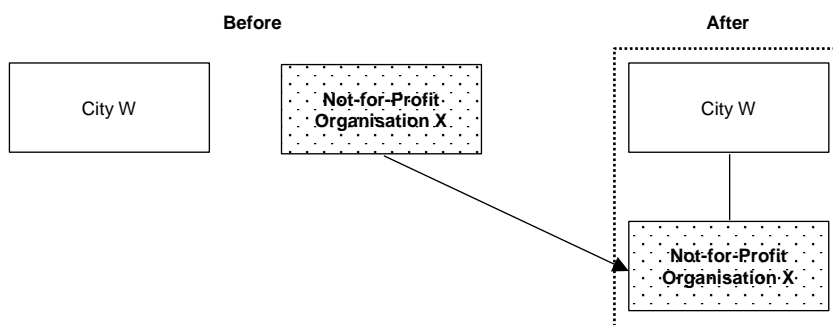

- IE149. In this scenario, City W nationalises Not-for-Profit Organisation X (a charity) as a result of a voluntary bailout. Prior to the nationalisation, Not-for-Profit Organisation X was in financial distress and approached City W for support. City W assumes Not-for-Profit Organisation X’s net liabilities. Following the purchase, Not-for-Profit Organisation X is managed as an arms-length, stand-alone entity.
- IE150. The nationalisation of Not-for-Profit Organisation X is a PBE combination. In determining whether this should be classified as an amalgamation or an acquisition, the first question City W considers is whether it has gained control of operations as a result of the combination.
- IE151. In this scenario, City W gains:
- Power over Not-for-Profit Organisation X;
  - Exposure, or rights, to variable benefits from its involvement with Not-for-Profit Organisation X; and

- (c) The ability to use its power over Not-for-Profit Organisation X to affect the nature or amount of the benefits from its involvement with Not-for-Profit Organisation X.

- IE152. City W concludes that, as a result of the PBE combination, it has gained control of Not-for-Profit Organisation X. City W considers the guidance in paragraphs 9–14 and AG19–AG50 of PBE IPSAS 40 in determining whether the economic substance of the combination is that of an amalgamation.
- IE153. In considering the economic substance of the PBE combination, City W notes that the combination results in a controlling entity/controlled entity relationship between City W and Not-for-Profit Organisation X. This is inconsistent with the economic substance of an amalgamation. City W also notes that, by assuming the net liabilities of Not-for-Profit Organisation X, the combination has commercial substance, which is suggestive of an acquisition.
- IE154. In considering the indicator relating to consideration, City W notes that the PBE combination does not include the payment of consideration. This would usually provide evidence that the economic substance of the combination is that of an amalgamation. However, in this scenario Not-for-Profit Organisation X has net liabilities that are assumed by City W as part of the combination. By assuming the net liabilities, City W relieves the trustees of Not-for-Profit Organisation X of the responsibility for settling the liabilities, therefore no payment of consideration by City W is necessary. City W concludes, therefore, that the indicator relating to consideration does not provide any evidence to suggest that the economic substance of the combination is that of an amalgamation.
- IE155. In considering the indicators relating to the decision-making process, City W notes that Not-for-Profit Organisation X voluntarily initiated the combination. City W concludes that the indicators relating to decision-making do not provide any evidence to suggest that the economic substance of the combination is that of an amalgamation.
- IE156. Taking these factors together, City W concludes that there is no evidence that the economic substance of the combination is that of an amalgamation, and that the PBE combination should, therefore, be classified as an acquisition.

*Scenario 15: Combination of Three Charities*

- IE156.1 The following diagram illustrates the combination of three charities providing similar services in different parts of the country.

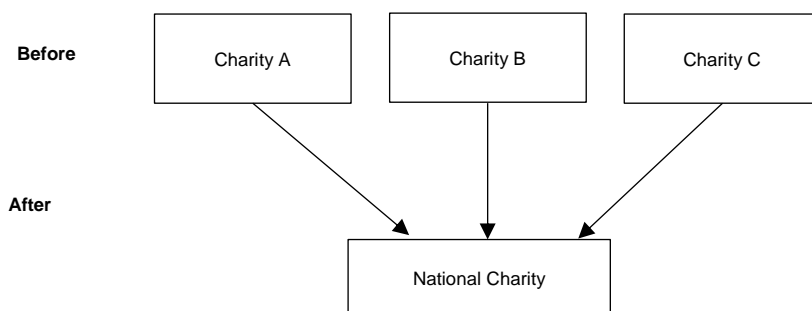

- IE156.2 Charity A covers the South Island, Charity B covers the lower North Island and Charity C covers the upper North Island. To gain operational efficiencies and make it easier to obtain grants, donations and other funding, the three charities decide to unite their resources and activities by forming a new national registered charity, National Charity. They establish National Charity at the time of the combination.
- IE156.3 The governing body of National Charity is formed through the appointment of trustees from the governing bodies of charities A, B and C. The former trustees of any one of the three charities do not constitute a majority of the governing body of the National Charity.
- IE156.4 All of the resources and activities of charities A, B and C are transferred to National Charity for nil consideration, whereupon charities A, B and C are wound up.
- IE156.5 In determining whether the combination of charities A, B and C should be classified as an amalgamation or an acquisition, the first question to consider is whether one of the parties has gained

control of operations as a result of the combination. National Charity is a newly formed entity that did not exist prior to the combination taking place. None of the existing charities (A, B and C) gained control of the other charities, nor do they have exposure, or rights, to variable benefits from their involvement with National Charity.

- IE156.6 Taking these factors together, National Charity concludes that the PBE combination should be classified as an amalgamation because no party to the combination has gained control of the other parties.

### **Accounting for Amalgamations**

#### **Eliminating Transactions between the Combining Operations – Loans**

*Illustrating the Consequences of Applying Paragraphs 22 and AG51–AG52 of PBE IPSAS 40*

- IE157. The following example illustrates the process for eliminating a loan between two combining operations not under common control.
- IE158. On 30 June 20X5 Resulting Entity (RE) is formed by an amalgamation of two municipalities, Combining Operation A (COA) and Combining Operation B (COB). Four years previously, COA had provided COB with a ten year, fixed interest rate loan of CU250. Interest on the loan is payable annually, with the principal repayable on maturity.
- IE159. COB has recently experienced financial difficulties, and at the amalgamation date was in arrears on making the interest payments. The carrying amount of the financial liability (the amortised cost of the loan) in its financial statements at the amalgamation date is CU260.
- IE160. Because of the arrears and the fact that COB was experiencing financial difficulties, COA had impaired the loan. The carrying amount of the financial asset (the loan) in its financial statements at the amalgamation date is CU200.
- IE161. At the amalgamation date, RE eliminates the financial asset received from COA and the financial liability assumed from COB and credits components of net assets/equity with CU60, the difference between the carrying amounts of the financial asset and the financial liability associated with the loan.

#### **Eliminating Transactions between the Combining Operations – Transfers**

*Illustrating the Consequences of Applying Paragraphs 22 and AG51–AG52 of PBE IPSAS 40*

- IE162. The following example illustrates the process for eliminating a transfer between two combining operations not under common control.
- IE163. On 30 June 20X9, RE is formed by an amalgamation of two government agencies, COA and COB. On 1 January 20X9, COA had provided COB with a grant of CU700 to be used in the provision of an agreed number of training courses.
- IE164. The grant was subject to a condition that the grant would be returned proportionately to the number of training courses not delivered. At the amalgamation date, COB had delivered half of the agreed number of courses, and recognised a liability of CU350 in respect of its performance obligation, in accordance with PBE IPSAS 23 *Revenue from Non-Exchange Transactions*. Based on past experience, COA considered that COB was more likely than not to deliver the training courses. It was therefore not probable that there would be a flow of resources to COA, and COA did not recognise an asset in respect of the grant, but accounted for the full CU700 as an expense.
- IE165. At the amalgamation date, the transaction is eliminated. There is no longer an obligation to an external party. The resulting entity does not recognise a liability for the CU350, but instead recognises this amount in net assets/equity.

### Adjusting the Carrying Amounts of the Assets and Liabilities of the Combining Operations to Conform to the Resulting Entity's Accounting Policies in an Amalgamation

#### *Illustrating the Consequences of Applying Paragraphs 26–27 and 36 of PBE IPSAS 40*

- IE166. The following example illustrates the process for adjusting the carrying amounts of the assets and liabilities of the combining operations to conform to the resulting entity's accounting policies in an amalgamation under common control.
- IE167. On 1 October 20X5 RE is formed by an amalgamation of two government departments, COA and COB. COA has previously adopted an accounting policy of measuring property, plant and equipment using the cost model in PBE IPSAS 17 *Property, Plant and Equipment*. COB has previously adopted an accounting policy of measuring property, plant and equipment using the revaluation model in PBE IPSAS 17.
- IE168. RE adopts an accounting policy of measuring property, plant and equipment using the revaluation model. RE seeks an independent valuation for the items of property, plant and equipment previously controlled by COA.
- IE169. On receiving the independent valuation for the items of property, plant and equipment previously controlled by COA, RE adjusts the carrying amounts of the items of property, plant and equipment as follows, with the corresponding entry being made to components of net assets/equity:

Class of Asset	Carrying Amount (CU)	Valuation (CU)	Adjustment (CU)
Land	17,623	18,410	787
Buildings	35,662	37,140	1,478
Vehicles	1,723	1,605	(118)

- IE170. RE also reviews the carrying amounts of the items of property, plant and equipment previously controlled by COB to ensure the amounts are up to date as at 1 October 20X5. The review confirms the carrying amounts of the items of property, plant and equipment previously controlled by COB are up to date and that no adjustment is required.
- IE171. RE recognises the items of property, plant and equipment previously controlled by COB at their carrying amounts. In accordance with paragraph 67 of PBE IPSAS 17, RE will review the residual values and useful lives of the plant and equipment previously controlled by both COA and COB at least at each annual reporting date. If expectations differ from previous estimates, RE will account for these changes as changes in accounting estimates, in accordance with PBE IPSAS 3 *Accounting Policies, Changes in Accounting Estimates and Errors*.

### Forgiveness of Amounts of Tax Due in an Amalgamation

#### *Illustrating the Consequences of Accounting for Tax Forgiveness in an Amalgamation by Applying Paragraphs 33 and AG57 of PBE IPSAS 40*

- IE172. The following example illustrates the accounting for an amalgamation not under common control in which the resulting entity's tax liability is forgiven as part of the terms of the amalgamation.
- IE173. On 1 January 20X6 RE is formed by an amalgamation of two public sector entities, COA and COB. The amalgamation is directed by the national government. RE, COA and COB have the same accounting policies; no adjustment to the carrying amounts of the assets and liabilities of COA and COB to conform to the resulting entity's accounting policies is required. At the date of the amalgamation, there are no amounts outstanding between COA and COB.

- IE174. In its statement of financial position as at 1 January 20X6, RE recognises and measures the assets and liabilities of COA and COB at their carrying amounts in their respective financial statements as of the amalgamation date:

<b>Statement of Financial Position:</b>	<b>COA (CU)</b>	<b>COB (CU)</b>	<b>RE (CU)</b>
Financial assets	1,205	997	2,202
Inventory	25	42	67
Property, plant and equipment	21,944	18,061	40,005
Intangible assets	0	3,041	3,041
Financial liabilities	(22,916)	(22,020)	(44,936)
Tax liabilities	(76)	(119)	(195)
Total net assets	182	2	184
Net Assets/Equity	182	2	184

- IE175. Suppose that the terms of the amalgamation include the Ministry of Finance (MF) (the tax authority) forgiving RE's tax liability. RE would derecognise the tax liability and make the adjustment to net assets/equity. The statement of financial position as at 1 January 20X6 for RE would be as follows:

<b>Statement of Financial Position:</b>	<b>RE (CU)</b>
Financial assets	2,202
Inventory	67
Property, plant and equipment	40,005
Intangible assets	3,041
Financial liabilities	(44,936)
Tax liabilities	0
Total net assets	379
Net Assets/Equity	379

- IE176. MF would recognise an adjustment for the tax forgiven, and account for the remaining tax receivable in accordance with PBE IPSAS 23.

### **Recognising and Measuring Components of Net Assets/Equity Arising as a Result of an Amalgamation**

#### *Illustrating the Consequences of Applying Paragraphs 37–39 of PBE IPSAS 40*

- IE177. The following example illustrates the accounting for recognising and measuring components of net assets/equity in an amalgamation.
- IE178. On 1 June 20X4, a new municipality RE is formed by the amalgamation of operations COA and COB relating to two geographical areas of other municipalities, not previously under common control.
- IE179. COB has previously performed services for COA for which it was to be paid CU750. Payment was outstanding at the amalgamation date. This transaction formed part of the carrying amount of financial liabilities for COA and part of the carrying amount of financial assets for COB.
- IE180. COA has previously adopted an accounting policy of measuring property, plant and equipment using the cost model. COB has previously adopted an accounting policy of measuring property, plant and equipment using the revaluation model. RE has adopted an accounting policy of measuring property, plant and equipment using the revaluation model. RE obtains an independent valuation for the items of property, plant and equipment previously controlled by COA. As a result, it increases its carrying

amount for those items of the property, plant and equipment by CU5,750 and makes the corresponding adjustment to components of net assets/equity.

- IE181. The carrying amounts of the assets, liabilities and components of net assets/equity transferred are summarised below. Adjustments to eliminate transactions between COA and COB (see paragraph 22), and to conform the carrying amounts to the resulting entity's accounting policies are also shown.

	COA (CU)	COB (CU)	Elimination Adjustments (CU)	Accounting Policy Adjustments (CU)	RE Opening Balance (CU)
Financial Assets	11,248	17,311	(750)	0	27,809
Inventory	1,072	532	0	0	1,604
Property, plant and equipment	5,663	12,171	0	5,750	23,584
Intangible assets	0	137	0	0	137
Financial liabilities	(18,798)	(20,553)	750	0	(38,601)
Total net assets/(liabilities)	(815)	9,598	0	5,750	14,533
Revaluation surplus	0	6,939	0	5,750	12,689
Accumulated comprehensive revenue and expense	(815)	2,659	0	0	1,844
Total net assets/equity	(815)	9,598	0	5,750	14,533

- IE182. In accordance with paragraphs 37–39 of PBE IPSAS 40, RE may present net assets/equity as either a single opening balance of CU14,533 or as the separate components shown above.
- IE183. The other municipalities that, prior to the amalgamation, controlled COA and COB would derecognise the assets, liabilities and components of net assets/equity transferred to RE in accordance with other PBE Standards.

### Measurement Period in an Amalgamation

#### *Illustrating the Consequences of Applying Paragraphs 40–44 of PBE IPSAS 40.*

- IE184. If the initial accounting for an amalgamation is not complete at the end of the financial reporting period in which the amalgamation occurs, paragraph 40 of PBE IPSAS 40 requires the resulting entity to recognise in its financial statements provisional amounts for the items for which the accounting is incomplete. During the measurement period, the resulting entity recognises adjustments to the provisional amounts needed to reflect new information obtained about facts and circumstances that existed as of the amalgamation date and, if known, would have affected the measurement of the amounts recognised as of that date. Paragraph 43 of PBE IPSAS 40 requires the resulting entity to recognise such adjustments as if the accounting for the amalgamation had been completed at the amalgamation date. Measurement period adjustments are not included in surplus or deficit.
- IE185. Suppose that RE is formed by the amalgamation of COA and COB (two municipalities that were not under common control prior to the amalgamation) on 30 November 20X3. Prior to the amalgamation, COA had an accounting policy of using the revaluation model for measuring land and buildings, whereas COB's accounting policy was to measure land and buildings using the cost model. RE adopts an accounting policy of measuring land and buildings using the revaluation model, and seeks an independent valuation for the land and buildings previously controlled by COB. This valuation was not

complete by the time RE authorised for issue its financial statements for the year ended 31 December 20X3. In its 20X3 annual financial statements, RE recognised provisional values for the land and buildings of CU150,000 and CU275,000 respectively. At the amalgamation date, the buildings had a remaining useful life of fifteen years. The land had an indefinite life. Four months after the amalgamation date, RE received the independent valuation, which estimated the amalgamation-date value of the land as CU160,000 and the amalgamation-date value of the buildings as CU365,000.

- IE186. In its financial statements for the year ended 31 December 20X4, RE retrospectively adjusts the 20X3 prior year information as follows:
- (a) The carrying amount of the land as of 31 December 20X3 is increased by CU10,000. As the land has an indefinite life, no depreciation is charged.
  - (b) The carrying amount of the buildings as of 31 December 20X3 is increased by CU89,500. That adjustment is measured as the valuation adjustment at the amalgamation date of CU90,000 less the additional depreciation that would have been recognised if the asset's value at the amalgamation date had been recognised from that date (CU500 for one month's depreciation).
  - (c) An adjustment of CU100,000 is recognised in net assets/equity as of 31 December 20X3.
  - (d) Depreciation expense for 20X3 is increased by CU500.
- IE187. In accordance with paragraph 56 of PBE IPSAS 40, RE discloses:
- (a) In its 20X3 financial statements, that the initial accounting for the amalgamation has not been completed because the valuation of land and buildings previously controlled by COB has not yet been received.
  - (b) In its 20X4 financial statements, the amounts and explanations of the adjustments to the provisional values recognised during the current reporting period. Therefore, RE discloses that the 20X3 comparative information is adjusted retrospectively to increase the value of the land and buildings by CU99,500 (CU100,000 at the amalgamation date), an increase in depreciation expense of CU500 and an increase in net assets/equity of CU100,000.

### **Subsequent Measurement of a Transfer Received by a Combining Operation on the Basis of Criteria that may Change as a Result of an Amalgamation**

*Illustrating the Consequences of Applying the Requirements in Paragraphs 48 and AG61–AG63 of PBE IPSAS 40.*

- IE188. The following example illustrates the subsequent accounting for a transfer received by a combining operation on the basis of criteria that may change as a result of an amalgamation.
- IE189. On 1 January 20X3, a national government provides an annual grant to those municipalities where the average household income is below a threshold. On 1 June 20X3, RE, a new municipality, is formed by the amalgamation of two existing municipalities, COA and COB. COA had previously received a grant of CU1,000, based on its average household income. COB has received no grant as its average household income was above the threshold.
- IE190. Following the amalgamation on 1 June 20X3, the average household income of RE is above the threshold that the government had set when allocating grants.
- IE191. On 1 July 20X3, the national government requires RE to repay a portion (CU200) of the grant previously paid to COA. RE recognises a liability and an expense of CU200 on 1 July 20X3.

### **Disclosure Requirements Relating to Amalgamations**

*Illustrating the Consequences of Applying the Disclosure Requirements in Paragraphs 53–57 of PBE IPSAS 40.*

- IE192. The following example illustrates some of the disclosure requirements relating to amalgamations of PBE IPSAS 40; it is not based on an actual transaction. The example assumes that RE is a newly created municipality formed by amalgamating the former municipalities COA and COB. The illustration presents the disclosures in a tabular format that refers to the specific disclosure requirements illustrated.



**Paragraph  
reference**

54(a)–(c) On 30 June 20X2 RE was formed by an amalgamation of the former municipalities COA and COB. Neither COA nor COB gained control of RE in the amalgamation. The amalgamation was mutually agreed by COA and COB, and enacted by the Government through legislation. The amalgamation aims to reduce costs through economies of scale, and to provide improved services to residents.

<b>Amounts recognised for each major class of assets and liabilities transferred as at 30 June 20X2</b>	
	<b>CU</b>
Financial assets	1,701
Inventory	5
Property, plant and equipment	74,656
Intangible assets	42
Financial liabilities	(2,001)
Total net assets	<u>74,403</u>

54(e) The following adjustments have been made to the carrying amounts of assets and liabilities recorded by COA and COB as at 30 June 20X2 prior to the amalgamation:

	<b>Original Amount (CU)</b>	<b>Adjustment (CU)</b>	<b>Revised Amount (CU)</b>
54(e)(i) Restatement of financial assets recorded by COA to eliminate transactions with COB	822	(25)	797
54(e)(i) Restatement of financial liabilities recorded by COB to eliminate transactions with COA	(1,093)	25	(1,068)
54(e)(ii) Restatement of property plant and equipment recorded by COA to measure the items using the revaluation model	12,116	17,954	30,070

<b>Amounts recognised in Net Assets/Equity as at 30 June 20X2</b>				
	<b>COA (CU)</b>	<b>COB (CU)</b>	<b>Adjustment (CU)</b>	<b>RE (CU)</b>
Revaluation surplus	0	18,332	17,954	36,286
Accumulated comprehensive revenue and expense	12,047	26,070	0	38,117
Total net assets/equity	<u>12,047</u>	<u>44,402</u>	<u>17,954</u>	<u>74,403</u>

**Paragraph  
reference**

54(h) At the time these financial statements were authorised for issue, the last reporting date for COA and COB was 31 December 20X1. The revenue and expense, and surplus or deficit for COA and COB from 1 January 20X2 to the amalgamation date (30 June 20X2), and the amounts reported by COA and COB for each major class of assets and liabilities, and for components of net assets/equity, is shown below:

	<b>COA (CU)</b>	<b>COB (CU)</b>
54(h)(i)	<b>Revenue</b>	
	45,213	70,369
	2,681	25,377
	32,615	19,345
	<b>80,509</b>	<b>115,091</b>
54(h)(i)	<b>Expenses</b>	
	(51,263)	(68,549)
	(18,611)	(26,445)
	(7,545)	(13,391)
	(677)	(2,598)
	(17)	(33)
	(2)	(3)
	<b>(78,115)</b>	<b>(111,019)</b>
54(h)(i)	<b>Surplus or (deficit) for the period 1 January 20X2 to 30 June 20X2</b>	
	<b>2,394</b>	<b>4,072</b>

54(h)(ii)	<b>Assets as at 30 June 20X2</b>	
	822	904
	0	5
	12,116	44,586
	42	0
	<b>12,980</b>	<b>45,495</b>
54(h)(ii)	<b>Liabilities as at 30 June 20X2</b>	
	(933)	(1,093)
	<b>(933)</b>	<b>(1,093)</b>
54(h)(iii)	<b>Net assets as at 30 June 20X2</b>	
	<b>12,047</b>	<b>44,402</b>
	<b>Net assets/equity as at 30 June 20X2</b>	
	0	18,332
	12,047	26,070
	<b>12,047</b>	<b>44,402</b>

In considering the disclosures related to an amalgamation, an entity may find it helpful to refer to the discussion of materiality in PBE IPSAS 1 *Presentation of Financial Reports*.

## Accounting for Acquisitions

### Reverse Acquisitions

*Illustrating the Consequences of Recognising a Reverse Acquisition by Applying Paragraphs AG66–AG71 of PBE IPSAS 40*

IE193. This example illustrates the accounting for a reverse acquisition in which Entity B, the legal controlled entity, acquires Entity A, the entity issuing equity instruments and therefore the legal controlling entity, in a reverse acquisition on 30 September 20X6. This example ignores the accounting for any income tax effects.

IE194. The statements of financial position of Entity A and Entity B immediately before the acquisition are:

	<b>Entity A (legal controlling entity, accounting acquired operation) CU</b>	<b>Entity B (legal controlled entity, accounting acquirer) CU</b>
Current assets	500	700
Non-current assets	1,300	3,000
Total assets	1,800	3,700
Current liabilities	300	600
Non-current liabilities	400	1,100
Total liabilities	700	1,700
Shareholders' equity		
Accumulated comprehensive revenue and expense	800	1,400
Issued equity		
100 ordinary shares	300	0
60 ordinary shares	0	600
Total shareholders' equity	1,100	2,000
Total liabilities and shareholders' equity	1,800	3,700

IE195. This example also uses the following information:

- (a) On 30 September 20X6 Entity A issues 2.5 shares in exchange for each ordinary share of Entity B. Entity B's sole shareholder, a government, exchanges its shares in Entity B. Therefore, Entity A issues 150 ordinary shares in exchange for all 60 ordinary shares of Entity B.
- (b) The fair value of each ordinary share of Entity B at 30 September 20X6 is CU40. The quoted market price of Entity A's ordinary shares at that date is CU16.
- (c) The fair values of Entity A's identifiable assets and liabilities at 30 September 20X6 are the same as their carrying amounts, except that the fair value of Entity A's non-current assets at 30 September 20X6 is CU1,500.

*Calculating the Fair Value of the Consideration Transferred*

- IE196. As a result of Entity A (legal controlling entity, accounting acquired operation) issuing 150 ordinary shares, Entity B's shareholder (the government) owns 60 percent of the issued shares of the combined entity (i.e., 150 of 250 issued shares). The remaining 40 percent is owned by Entity A's shareholders. If the acquisition had taken the form of Entity B issuing additional ordinary shares to Entity A's shareholders in exchange for their ordinary shares in Entity A, Entity B would have had to issue 40 shares for the ratio of ownership interest in the combined entity to be the same. Entity B's shareholder (the government) would then own 60 of the 100 issued shares of Entity B—60 percent of the combined entity. As a result, the fair value of the consideration effectively transferred by Entity B and the group's interest in Entity A is CU1,600 (40 shares with a fair value per share of CU40).
- IE197. The fair value of the consideration effectively transferred should be based on the most reliable measure. In this example, the quoted price of Entity A's shares in the principal (or most advantageous) market for the shares provides a more reliable basis for measuring the consideration effectively transferred than the fair value of the shares in Entity B, and the consideration is measured using the market price of Entity A's shares—100 shares with a fair value per share of CU16.

*Measuring Goodwill*

- IE198. Goodwill is measured as the excess of the fair value of the consideration effectively transferred (the group's interest in Entity A) over the net amount of Entity A's recognised identifiable assets and liabilities, as follows:

	CU	CU
Consideration effectively transferred		1,600
Net recognised values of Entity A's identifiable assets and liabilities		
Current assets	500	
Non-current assets	1,500	
Current liabilities	(300)	
Non-current liabilities	(400)	(1,300)
Goodwill	300	300

*Consolidated Statement of Financial Position as at 30 September 20X6*

IE199. The consolidated statement of financial position immediately after the acquisition is:

	CU
Current assets [CU700 + CU500]	1,200
Non-current assets [CU3,000 + CU1,500]	4,500
Goodwill	300
Total assets	6,000
Current liabilities [CU600 + CU300]	900
Non-current liabilities [CU1,100 + CU400]	1,500
Total liabilities	2,400
Shareholders' equity	
Accumulated comprehensive revenue and expense	1,400
Issued equity	
250 ordinary shares [CU600 + CU1,600]	2,200
Total shareholders' equity	3,600
Total liabilities and shareholders' equity	6,000

IE200. The amount recognised as issued equity interests in the consolidated financial statements (CU2,200) is determined by adding the issued equity of the legal controlled entity immediately before the acquisition (CU600) and the fair value of the consideration effectively transferred (CU1,600). However, the equity structure appearing in the consolidated financial statements (i.e., the number and type of equity interests issued) must reflect the equity structure of the legal controlling entity, including the equity interests issued by the legal controlling entity to effect the combination.

*Non-Controlling Interest*

IE201. Assume the same facts as above, except that Entity B has more than one shareholder, and that only 56 of Entity B's 60 ordinary shares are exchanged. Because Entity A issues 2.5 shares in exchange for each ordinary share of Entity B, Entity A issues only 140 (rather than 150) shares. As a result, Entity B's shareholders own 58.3 percent of the issued shares of the combined entity (140 of 240 issued shares). The fair value of the consideration transferred for Entity A, the accounting acquired operation, is calculated by assuming that the combination had been effected by Entity B issuing additional ordinary shares to the shareholders of Entity A in exchange for their ordinary shares in Entity A. That is because Entity B is the accounting acquirer, and paragraph AG67 of PBE IPSAS 40 requires the acquirer to measure the consideration exchanged for the accounting acquired operation.

IE202. In calculating the number of shares that Entity B would have had to issue, the non-controlling interest is excluded from the calculation. The majority shareholder (the government) owns 56 shares of Entity B. For that to represent a 58.3 percent equity interest, Entity B would have had to issue an additional 40 shares. The majority shareholder (the government) would then own 56 of the 96 issued shares of Entity B and, therefore, 58.3 percent of the combined entity. As a result, the fair value of the consideration transferred for Entity A, the accounting acquired operation, is CU1,600 (i.e., 40 shares, each with a fair value of CU40). That is the same amount as when Entity B's sole shareholder tenders all 60 of its ordinary shares for exchange. The recognised amount of the group's interest in Entity A, the accounting acquired operation, does not change if some of Entity B's shareholders do not participate in the exchange.

- IE203. The non-controlling interest is represented by the four shares of the total 60 shares of Entity B that are not exchanged for shares of Entity A. Therefore, the non-controlling interest is 6.7 percent. The non-controlling interest reflects the proportionate interest of the non-controlling shareholders in the pre-combination carrying amounts of the net assets of Entity B, the legal controlled entity. Therefore, the consolidated statement of financial position is adjusted to show a non-controlling interest of 6.7 percent of the pre-combination carrying amounts of Entity B's net assets (i.e., CU134 or 6.7 percent of CU2,000).
- IE204. The consolidated statement of financial position as at 30 September 20X6, reflecting the non-controlling interest, is as follows:

	CU
Current assets [CU700 + CU500]	1,200
Non-current assets [CU3,000 + CU1,500]	4,500
Goodwill	300
Total assets	6,000
Current liabilities [CU600 + CU300]	900
Non-current liabilities [CU1,100 + CU400]	1,500
Total liabilities	2,400
Shareholders' equity	
Accumulated comprehensive revenue and expense [CU1,400 × 93.3 percent]	1,306
Issued equity	
240 ordinary shares [CU560 + CU1,600]	2,160
Non-controlling interest	134
Total shareholders' equity	3,600
Total liabilities and shareholders' equity	6,000

- IE205. The non-controlling interest of CU134 has two components. The first component is the reclassification of the non-controlling interest's share of the accounting acquirer's accumulated comprehensive revenue and expense immediately before the acquisition (CU1,400 × 6.7 percent or CU93.80). The second component represents the reclassification of the non-controlling interest's share of the accounting acquirer's issued equity (CU600 × 6.7 percent or CU40.20).

### Identifiable Intangible Assets in an Acquisition

#### *Illustrating the Consequences of Applying Paragraphs 64–68 and AG75–AG84 of PBE IPSAS 40*

- IE206. The following are examples of identifiable intangible assets acquired in an acquisition. Some of the examples may have characteristics of assets other than intangible assets. The acquirer should account for those assets in accordance with their substance. The examples are not intended to be all-inclusive.
- IE207. Intangible assets identified as having a 'binding arrangement' basis are those that arise from binding arrangements (including rights from contracts or other legal rights). Those designated as having a 'no binding arrangement' basis do not arise from binding arrangements but are separable. Intangible assets identified as having a binding arrangement basis might also be separable but separability is not a necessary condition for an asset to meet the binding arrangement criterion.

*Marketing-Related Intangible Assets*

IE208. Marketing-related intangible assets are used primarily in the marketing or promotion of products or services. Examples of marketing-related intangible assets are:

<b>Class</b>	<b>Basis</b>
Trademarks, trade names, service marks, collective marks and certification marks	Binding arrangement
Trade dress (unique colour, shape or package design)	Binding arrangement
Newspaper mastheads	Binding arrangement
Internet domain names	Binding arrangement
Non-competition agreements	Binding arrangement

## Trademarks, Trade Names, Service Marks, Collective Marks and Certification Marks

IE209. Trademarks are words, names, symbols or other devices used in trade to indicate the source of a product and to distinguish it from the products of others. A service mark identifies and distinguishes the source of a service rather than a product. Collective marks identify the goods or services of members of a group. Certification marks certify the geographical origin or other characteristics of a good or service.

IE210. Trademarks, trade names, service marks, collective marks and certification marks may be protected legally through registration with governmental agencies, continuous use in commerce or by other means. If it is protected legally through registration or other means, a trademark or other mark acquired in an acquisition is an intangible asset that meets the binding arrangement criterion. Otherwise, a trademark or other mark acquired in an acquisition can be recognised separately from goodwill if the separability criterion is met, which normally it would be.

IE211. The terms *brand* and *brand name*, often used as synonyms for trademarks and other marks, are general marketing terms that typically refer to a group of complementary assets such as a trademark (or service mark) and its related trade name, formulas, recipes and technological expertise. PBE IPSAS 40 does not preclude an entity from recognising, as a single asset separately from goodwill, a group of complementary intangible assets commonly referred to as a brand if the assets that make up that group have similar useful lives.

## Internet Domain Names

IE212. An Internet domain name is a unique alphanumeric name that is used to identify a particular numeric Internet address. Registration of a domain name creates an association between that name and a designated computer on the Internet for the period of the registration. Those registrations are renewable. A registered domain name acquired in an acquisition meets the binding arrangement criterion.

*Service User or Customer-Related Intangible Assets*

IE213. Examples of service user or customer-related intangible assets are:

<b>Class</b>	<b>Basis</b>
Lists of users of a service	No binding arrangement
Order or production backlog	Binding arrangement
Customer binding arrangements and the related customer relationships	Binding arrangement
Customer relationships arising through means other than binding arrangements	No binding arrangement

## Lists of Users of a Service

IE214. A list of users of a service consists of information about service users, such as their names and contact information. A list of users of a service also may be in the form of a database that includes other information about the users, such as their service use histories and demographic information. A list of

users of a service does not usually arise from a binding arrangement (including rights from contracts or other legal rights). However, lists of users of a service are often leased or exchanged. Therefore, a list of users of a service acquired in an acquisition normally meets the separability criterion.

#### Order or Production Backlog

- IE215. An order or production backlog arises from binding arrangements such as purchase or sales orders. An order or production backlog acquired in an acquisition meets the binding arrangement criterion even if the purchase or sales orders can be cancelled.

#### Customer Binding Arrangements and the Related Customer Relationships

- IE216. If an entity establishes relationships with its customers through binding arrangements, those customer relationships arise from binding arrangement rights. Therefore, customer binding arrangements and the related customer relationships acquired in an acquisition meet the binding arrangement criterion, even if confidentiality or other terms of the binding arrangement prohibit the sale or transfer of a binding arrangement separately from the acquired operation.
- IE217. A customer binding arrangement and the related customer relationship may represent two distinct intangible assets. Both the useful lives and the pattern in which the economic benefits of the two assets are consumed may differ.
- IE218. A customer relationship exists between an entity and its customer if (a) the entity has information about the customer and has regular contact with the customer and (b) the customer has the ability to make direct contact with the entity. Customer relationships meet the binding arrangement criterion if an entity has a practice of establishing binding arrangements with its customers, regardless of whether a binding arrangement exists at the acquisition date. Customer relationships may also arise through means other than binding arrangements, such as through regular contact by sales or service representatives.
- IE219. As noted in paragraph IE215, an order or a production backlog arises from binding arrangements such as purchase or sales orders and is therefore considered a binding arrangement right. Consequently, if an entity has relationships with its customers through these types of binding arrangements, the customer relationships also arise from binding arrangement rights and therefore meet the binding arrangement criterion.

#### Examples

- IE220. The following examples illustrate the recognition of customer binding arrangement and customer relationship intangible assets acquired in an acquisition.

- (a) Acquirer Entity (AE) acquires Target Entity (TE) in an acquisition on 31 December 20X5. TE has a five-year agreement to supply goods to Customer. Both TE and AE believe that Customer will renew the agreement at the end of the current binding arrangement. The agreement is not separable.

The agreement, whether cancellable or not, meets the binding arrangement criterion. Additionally, because TE establishes its relationship with Customer through a binding arrangement, not only the agreement itself but also TE's customer relationship with Customer meet the binding arrangement criterion.

- (b) AE acquires TE in an acquisition on 31 December 20X5. TE manufactures goods in two distinct lines of business: sporting goods and electronics. Customer purchases both sporting goods and electronics from TE. TE has a binding arrangement with Customer to be its exclusive provider of sporting goods but has no binding arrangement for the supply of electronics to Customer. Both TE and AE believe that only one overall customer relationship exists between TE and Customer.

The binding arrangement to be Customer's exclusive supplier of sporting goods, whether cancellable or not, meets the binding arrangement criterion. Additionally, because TE establishes its relationship with Customer through a binding arrangement, the customer relationship with Customer meets the binding arrangement criterion. Because TE has only one customer relationship with Customer, the fair value of that relationship incorporates assumptions about TE's relationship with Customer related to both sporting goods and electronics. However, if AE determines that the customer relationships with Customer for



sporting goods and for electronics are separate from each other, AE would assess whether the customer relationship for electronics meets the separability criterion for identification as an intangible asset.

- (c) AE acquires TE in an acquisition on 31 December 20X5. TE does business with its customers solely through purchase and sales orders. At 31 December 20X5, TE has a backlog of customer purchase orders from 60 percent of its customers, all of whom are recurring customers. The other 40 percent of TE's customers are also recurring customers. However, as of 31 December 20X5, TE has no open purchase orders or other binding arrangements with those customers.

Regardless of whether they are cancellable or not, the purchase orders from 60 percent of TE's customers meet the binding arrangement criterion. Additionally, because TE has established its relationship with 60 percent of its customers through binding arrangements, not only the purchase orders but also TE's customer relationships meet the binding arrangement criterion. Because TE has a practice of establishing binding arrangements with the remaining 40 percent of its customers, its relationship with those customers also arises through binding arrangement rights and therefore meets the binding arrangement criterion even though TE does not have binding arrangements with those customers at 31 December 20X5.

- (d) AE acquires TE, an insurer, in an acquisition on 31 December 20X5. TE has a portfolio of one-year motor insurance contracts that are cancellable by policyholders.

Because TE establishes its relationships with policyholders through insurance contracts, the customer relationship with policyholders meets the binding arrangement criterion. PBE IPSAS 26 *Impairment of Cash-Generating Assets* and PBE IPSAS 31 *Intangible Assets* apply to the customer relationship intangible asset.

#### Customer Relationships Arising through Means Other than Binding Arrangements

- IE221. A customer relationship acquired in an acquisition that does not arise from a binding arrangement may nevertheless be identifiable because the relationship is separable. Exchange transactions for the same asset or a similar asset that indicate that other entities have sold or otherwise transferred a particular type of customer relationship arising through means other than binding arrangements would provide evidence that the relationship is separable.

#### *Artistic-Related Intangible Assets*

- IE222. Examples of artistic-related intangible assets are:

<b>Class</b>	<b>Basis</b>
Plays, operas and ballets	Binding arrangement
Books, magazines, newspapers and other literary works	Binding arrangement
Musical works such as compositions, song lyrics and advertising jingles	Binding arrangement
Pictures and photographs	Binding arrangement
Video and audio-visual material, including motion pictures or films, music videos and television programmes	Binding arrangement

- IE223. Artistic-related assets acquired in an acquisition are identifiable if they arise from binding arrangements (including rights from contracts) or legal rights such as those provided by copyright. The holder can transfer a copyright, either in whole through an assignment or in part through a licensing agreement. An acquirer is not precluded from recognising a copyright intangible asset and any related assignments or licence agreements as a single asset, provided they have similar useful lives.

#### *Binding Arrangement-Based Intangible Assets*

- IE224. Binding arrangement-based intangible assets represent the value of rights that arise from binding arrangements. Binding arrangements with customers are one type of binding arrangement-based intangible asset. If the terms of a binding arrangement give rise to a liability (for example, if the terms

of an operating lease or binding arrangement with a customer are unfavourable relative to market terms), the acquirer recognises it as a liability assumed in the acquisition. Examples of binding arrangement-based intangible assets are:

<b>Class</b>	<b>Basis</b>
Licensing, royalty and standstill agreements	Binding arrangement
Advertising, construction, management, service or supply binding arrangements	Binding arrangement
Lease agreements (whether the acquired operation is the lessee or the lessor)	Binding arrangement
Construction permits	Binding arrangement
Franchise agreements	Binding arrangement
Operating and broadcast rights	Binding arrangement
Servicing binding arrangements, such as mortgage servicing binding arrangements	Binding arrangement
Binding arrangements for employment	Binding arrangement
Use rights, such as drilling, water, air, timber cutting and route authorities	Binding arrangement

#### Servicing Binding Arrangements, such as Mortgage Servicing Binding Arrangements

IE225. Binding arrangements to service financial assets are one type of binding arrangement-based intangible asset. Although servicing is inherent in all financial assets, it becomes a distinct asset (or liability) by one of the following:

- (a) When separated in the binding arrangement from the underlying financial asset by sale or securitisation of the assets with servicing retained;
- (b) Through the separate purchase and assumption of the servicing.

IE226. If mortgage loans, credit card receivables or other financial assets are acquired in an acquisition with servicing retained, the inherent servicing rights are not a separate intangible asset because the fair value of those servicing rights is included in the measurement of the fair value of the acquired financial asset.

#### Binding Arrangements for Employment

IE227. Binding arrangements for employment that are beneficial binding arrangements from the perspective of the employer because the pricing of those binding arrangements is favourable relative to market terms are one type of binding arrangement-based intangible asset.

#### Use Rights

IE228. Use rights include rights for drilling, water, air, timber cutting and route authorities. Some use rights are binding arrangement-based intangible assets to be accounted for separately from goodwill. Other use rights may have characteristics of tangible assets rather than of intangible assets. An acquirer should account for use rights on the basis of their nature.

#### *Technology-Based Intangible Assets*

IE229. Examples of technology-based intangible assets are:

<b>Class</b>	<b>Basis</b>
Patented technology	Binding arrangement
Computer software and mask works	Binding arrangement
Unpatented technology	No binding arrangement
Databases, including title plants	No binding arrangement
Trade secrets, such as secret formulas, processes and recipes	Binding arrangement

## Computer Software and Mask Works

- IE230. Computer software and programme formats acquired in an acquisition that are protected legally, such as by patent or copyright, meet the binding arrangement criterion for identification as intangible assets.
- IE231. Mask works are software permanently stored on a read-only memory chip as a series of stencils or integrated circuitry. Mask works may have legal protection. Mask works with legal protection that are acquired in an acquisition meet the binding arrangement criterion for identification as intangible assets.

## Databases, Including Title Plants

- IE232. Databases are collections of information, often stored in electronic form (such as on computer disks or files). A database that includes original works of authorship may be entitled to copyright protection. A database acquired in an acquisition and protected by copyright meets the binding arrangement criterion. However, a database typically includes information created as a consequence of an entity's normal operations, such as lists of service users, or specialised information, such as scientific data or credit information. Databases that are not protected by copyright can be, and often are, exchanged, licensed or leased to others in their entirety or in part. Therefore, even if the future economic benefits from a database do not arise from legal rights, a database acquired in an acquisition meets the separability criterion.
- IE233. Title plants constitute a historical record of all matters affecting title to parcels of land in a particular geographical area. Title plant assets are bought and sold, either in whole or in part, in exchange transactions or are licensed. Therefore, title plant assets acquired in an acquisition meet the separability criterion.

## Trade Secrets, such as Secret Formulas, Processes and Recipes

- IE234. A trade secret is 'information, including a formula, pattern, recipe, compilation, programme, device, method, technique, or process that (a) derives independent economic value, actual or potential, from not being generally known and (b) is the subject of efforts that are reasonable under the circumstances to maintain its secrecy.'<sup>21</sup> If the future economic benefits from a trade secret acquired in an acquisition are legally protected, that asset meets the binding arrangement criterion. Otherwise, trade secrets acquired in an acquisition are identifiable only if the separability criterion is met, which is likely to be the case.

**Measurement of Non-Controlling Interest (NCI) in an Acquisition***Illustrating the Consequences of Applying Paragraph 73 of PBE IPSAS 40.*

- IE235. The following examples illustrate the measurement of components of NCI at the acquisition date in an acquisition.

*Measurement of NCI Including Preference Shares*

- IE236. TE has issued 100 preference shares, which are classified as equity. The preference shares have a nominal value of CU1 each. The preference shares give their holders a right to a preferential dividend in priority to the payment of any dividend to the holders of ordinary shares. Upon liquidation of TE, the holders of the preference shares are entitled to receive out of the assets available for distribution the amount of CU1 per share in priority to the holders of ordinary shares. The holders of the preference shares do not have any further rights on liquidation.
- IE237. AE acquires all ordinary shares of TE. The transaction gives AE control of TE, and an analysis of the economic substance of the combination using the guidance in paragraphs 9–14 and AG19–AG50 of PBE IPSAS 40 confirms the transaction is an acquisition. The acquisition-date fair value of the preference shares is CU120.
- IE238. Paragraph 73 of PBE IPSAS 40 states that for each acquisition, the acquirer shall measure at the acquisition date components of non-controlling interest in the acquired operation that are present ownership interests and entitle their holders to a proportionate share of the entity's net assets in the

<sup>21</sup> Melvin Simensky and Lanning Bryer, *The New Role of Intellectual Property in Commercial Transactions* (New York: John Wiley & Sons, 1998), page 293.

event of liquidation at either fair value or the present ownership instruments' proportionate share in the acquired operation's recognised amounts of the identifiable net assets. All other components of non-controlling interest must be measured at their acquisition-date fair value, unless another measurement basis is required by PBE Standards.

- IE239. The non-controlling interests that relate to TE's preference shares do not qualify for the measurement choice in paragraph 73 of PBE IPSAS 40 because they do not entitle their holders to a proportionate share of the entity's net assets in the event of liquidation. The acquirer measures the preference shares at their acquisition-date fair value of CU120.

#### *First Variation*

- IE240. Suppose that upon liquidation of TE, the preference shares entitle their holders to receive a proportionate share of the assets available for distribution. The holders of the preference shares have equal right and ranking to the holders of ordinary shares in the event of liquidation. Assume that the acquisition-date fair value of the preference shares is now CU160 and that the proportionate share of TE's recognised amounts of the identifiable net assets that is attributable to the preference shares is CU140.
- IE241. The preference shares qualify for the measurement choice in paragraph 73 of PBE IPSAS 40. AE can choose to measure the preference shares either at their acquisition-date fair value of CU160 or at their proportionate share in the acquired operation's recognised amounts of the identifiable net assets of CU140.

#### *Second Variation*

- IE242. Suppose also that TE has issued share options as remuneration to its employees. The share options are classified as equity and are vested at the acquisition date. They do not represent present ownership interest and do not entitle their holders to a proportionate share of TE's net assets in the event of liquidation. The fair value of the share options in accordance with the relevant international or national accounting standard dealing with share-based payments at the acquisition date is CU200. The share options do not expire on the acquisition date and AE does not replace them.
- IE243. Paragraph 73 of PBE IPSAS 40 requires such share options to be measured at their acquisition-date fair value, unless another measurement basis is required by PBE Standards. Paragraph 84 of PBE IPSAS 40 states that the acquirer shall measure an equity instrument related to share-based payment transactions of the acquired operation in accordance with the relevant international or national accounting standard dealing with share-based payments.
- IE244. The acquirer measures the non-controlling interests that are related to the share options at their fair value of CU200.

### **Forgiveness of Amounts of Tax Due in an Acquisition**

#### *Illustrating the Consequences of Accounting for Tax Forgiveness in an Acquisition by Applying Paragraphs 78, AG85 and AG87 of PBE IPSAS 40*

- IE245. The following example illustrates the accounting for an acquisition in which part of the acquired operation's tax liability is forgiven as part of the terms of the acquisition.
- IE246. On 1 January 20X4 AE, a government ministry acting on behalf of the government, acquires TE, a private entity in exchange for cash of CU575. As a result of the acquisition, AE expects to reduce costs through economies of scale. The fair value of the assets acquired and liabilities assumed are as follows:

<b>Assets acquired and liabilities assumed:</b>	<b>CU</b>
Financial assets	265
Inventory	5
Property, plant and equipment	640
Identifiable intangible assets	12
Financial liabilities	(320)

Tax liabilities	(40)
Total net assets	562

- IE247. AE recognises goodwill of CU13, the difference between the price paid to acquire TE (CU575) and the net assets of TE (CU562).
- IE248. Suppose that as part of the terms of the acquisition, the government requires MF (the tax authority) to forgive 50 percent of TE's tax liability. The fair value of the assets acquired and liabilities assumed would now be as follows:

<b>Assets acquired and liabilities assumed:</b>	<b>CU</b>
Financial assets	265
Inventory	5
Property, plant and equipment	640
Identifiable intangible assets	12
Financial liabilities	(320)
Tax liabilities	(20)
Total net assets	582

- IE249. AE recognises a gain of CU7, the difference between the price paid to acquire TE (CU575) and the net assets of TE (CU582). AE would account for the remaining tax liability in accordance with PBE IAS 12 *Income Taxes*.
- IE250. MF would recognise an adjustment for the tax forgiven, and account for the remaining tax receivable in accordance with PBE IPSAS 23.

### Gain on a Bargain Purchase in an Acquisition

#### *Illustrating the Consequences of Recognising and Measuring a Gain from a Bargain Purchase in an Acquisition by Applying Paragraphs 85–90 of PBE IPSAS 40*

- IE251. The following example illustrates the accounting for an acquisition in which a gain on a bargain purchase is recognised.
- IE252. On 1 January 20X5 AE acquires 80 percent of the equity interests of TE, a private entity, in exchange for cash of CU150. Because the former owners of TE needed to dispose of their investments in TE by a specified date, they did not have sufficient time to market TE to multiple potential buyers. The management of AE initially measures the separately recognisable identifiable assets acquired and the liabilities assumed as of the acquisition date in accordance with the requirements of PBE IPSAS 40. The identifiable assets are measured at CU250 and the liabilities assumed are measured at CU50. AE engages an independent consultant, who determines that the fair value of the 20 percent non-controlling interest in TE is CU42.
- IE253. The amount of TE's identifiable net assets (CU200, calculated as CU250 – CU50) exceeds the fair value of the consideration transferred plus the fair value of the non-controlling interest in TE. Therefore, AE reviews the procedures it used to identify and measure the assets acquired and liabilities assumed and to measure the fair value of both the non-controlling interest in TE and the consideration

transferred. After that review, AE decides that the procedures and resulting measures were appropriate. AE measures the gain on its purchase of the 80 percent interest as follows:

	CU	CU
Amount of the identifiable net assets acquired (CU250 – CU50)		200
Less: Fair value of the consideration transferred for AE’s 80 percent interest in TE; plus	150	
Fair value of non-controlling interest in TE	42	
Gain on bargain purchase of 80 percent interest		8

IE254. AE would record its acquisition of TE in its consolidated financial statements as follows:

	CU	CU
Dr Identifiable assets acquired	250	
Cr Cash		150
Cr Liabilities assumed		50
Cr Gain on the bargain purchase		8
Cr Equity—non-controlling interest in TE		42

IE255. If the acquirer chose to measure the non-controlling interest in TE on the basis of its proportionate interest in the identifiable net assets of the acquired operation, the recognised amount of the non-controlling interest would be CU40 (CU200 × 0.20). The gain on the bargain purchase then would be CU10 (CU200 – (CU150 + CU40)).

### Measurement Period in an Acquisition

*Illustrating the Consequences of Applying Paragraphs 103–108 of PBE IPSAS 40.*

IE256. If the initial accounting for an acquisition is not complete at the end of the financial reporting period in which the combination occurs, paragraph 103 of PBE IPSAS 40 requires the acquirer to recognise in its financial statements provisional amounts for the items for which the accounting is incomplete. During the measurement period, the acquirer recognises adjustments to the provisional amounts needed to reflect new information obtained about facts and circumstances that existed as of the acquisition date and, if known, would have affected the measurement of the amounts recognised as of that date. Paragraph 107 of PBE IPSAS 40 requires the acquirer to recognise such adjustments as if the accounting for the acquisition had been completed at the acquisition date. Measurement period adjustments are not included in surplus or deficit.

IE257. Suppose that AE acquires TE on 30 September 20X7. AE seeks an independent valuation for an item of property, plant and equipment acquired in the combination, and the valuation was not complete by the time AE authorised for issue its financial statements for the year ended 31 December 20X7. In its 20X7 annual financial statements, AE recognised a provisional fair value for the asset of CU30,000. At the acquisition date, the item of property, plant and equipment had a remaining useful life of five years. Five months after the acquisition date, AE received the independent valuation, which estimated the asset’s acquisition-date fair value as CU40,000.

IE258. In its financial statements for the year ended 31 December 20X8, AE retrospectively adjusts the 20X7 prior year information as follows:

- (a) The carrying amount of property, plant and equipment as of 31 December 20X7 is increased by CU9,500. That adjustment is measured as the fair value adjustment at the acquisition date of CU10,000 less the additional depreciation that would have been recognised if the asset’s fair value at the acquisition date had been recognised from that date (CU500 for three months’ depreciation).

- (b) The carrying amount of goodwill as of 31 December 20X7 is decreased by CU10,000.
- (c) Depreciation expense for 20X7 is increased by CU500.

IE259. In accordance with paragraph 124 of PBE IPSAS 40, AE discloses:

- (a) In its 20X7 financial statements, that the initial accounting for the acquisition has not been completed because the valuation of property, plant and equipment has not yet been received.
- (b) In its 20X8 financial statements, the amounts and explanations of the adjustments to the provisional values recognised during the current reporting period. Therefore, AE discloses that the 20X7 comparative information is adjusted retrospectively to increase the fair value of the item of property, plant and equipment at the acquisition date by CU9,500, offset by a decrease to goodwill of CU10,000 and an increase in depreciation expense of CU500.

### **Determining what is Part of the Acquisition Transaction**

#### *Settlement of a Pre-Existing Relationship –Loan*

##### *Illustrating the Consequences of Applying Paragraphs 109–110 and AG98–AG101 of PBE IPSAS 40.*

- IE260. AE provides TE with a five year, fixed rate loan of CU100. Interest is payable quarterly, with the principal repaid on maturity. With two years remaining under the loan agreement, AE acquires TE.
- IE261. Included in the total fair value of TE is a CU90 financial liability for the fair value of the loan arrangement with AE. At the acquisition date, the carrying amount of the corresponding financial asset in AE's financial statements (the amortised cost of the loan) is CU100.
- IE262. In this example, AE calculates a loss of CU10. The loss is calculated as the difference between the fair value of the financial liability assumed and carrying amount of the corresponding financial asset previously recognised by AE. In its consolidated financial statements, AE will eliminate its financial asset (CU100) against the fair value of TE's financial liability (CU90), the difference representing the loss to AE.

#### *Settlement of a Pre-Existing Relationship –Transfers*

##### *Illustrating the Consequences of Applying Paragraphs 109–110 and AG98–AG101 of PBE IPSAS 40.*

- IE263. On 1 January 20X7, AE acquires TE. Previously, on 1 October 20X6, AE provided TE with a grant of CU800 to be used in the provision of an agreed number of training courses.
- IE264. The grant was subject to a condition that the grant would be returned proportionately to the number of training courses not delivered. At the acquisition date, TE had delivered a quarter of the agreed number of courses, and recognised a liability of CU600 in respect of its performance obligation, in accordance with PBE IPSAS 23. Based on past experience, AE considered that TE was more likely than not to deliver the training courses. It was therefore not probable that there would be a flow of resources to AE, and AE did not recognise an asset in respect of the grant, but accounted for the full CU800 as an expense.
- IE265. In this example, AE calculates a gain of CU600. The gain is calculated as the liability assumed that is derecognised because, as a result of the acquisition, there is no longer an obligation owed to a third party.
- IE266. In this example, no corresponding asset had been recognised by AE; if AE had previously recognised a corresponding asset, this would be derecognised at the acquisition date, and the derecognised amount would be included in the calculation of the gain or loss.

#### *Settlement of a Pre-Existing Relationship –Supply Contract*

##### *Illustrating the Consequences of Applying Paragraphs 109–110 and AG98–AG101 of PBE IPSAS 40.*

- IE267. AE purchases electronic components from TE under a five-year supply contract at fixed rates. Currently, the fixed rates are higher than the rates at which AE could purchase similar electronic components from another supplier. The supply contract allows AE to terminate the contract before the end of the initial five-year term but only by paying a CU6 million penalty. With three years remaining

under the supply contract, AE pays CU50 million to acquire TE, which is the fair value of TE based on what other market participants would be willing to pay.

- IE268. Included in the total fair value of TE is CU8 million related to the fair value of the supply contract with AE. The CU8 million represents a CU3 million component that is 'at market' because the pricing is comparable to pricing for current market transactions for the same or similar items (selling effort, customer relationships and so on) and a CU5 million component for pricing that is unfavourable to AE because it exceeds the price of current market transactions for similar items. TE has no other identifiable assets or liabilities related to the supply contract, and AE has not recognised any assets or liabilities related to the supply contract before the acquisition.
- IE269. In this example, AE calculates a loss of CU5 million (the lesser of the CU6 million stated settlement amount and the amount by which the contract is unfavourable to the acquirer) separately from the acquisition. The CU3 million 'at-market' component of the contract is part of goodwill.
- IE270. Whether AE had recognised previously an amount in its financial statements related to a pre-existing relationship will affect the amount recognised as a gain or loss for the effective settlement of the relationship. Suppose that PBE Standards had required AE to recognise a CU6 million liability for the supply contract before the acquisition. In that situation, AE recognises a CU1 million settlement gain on the contract in surplus or deficit at the acquisition date (the CU5 million measured loss on the contract less the CU6 million loss previously recognised). In other words, AE has in effect settled a recognised liability of CU6 million for CU5 million, resulting in a gain of CU1 million.

#### *Contingent Payments to Employees in an Acquisition*

##### *Illustrating the Consequences of Applying Paragraphs 109–110, AG98 and AG102–AG103 of PBE IPSAS 40.*

- IE271. TE appointed a candidate as its new CEO under a ten-year contract. The contract required TE to pay the candidate CU5 million if TE is acquired before the contract expires. AE acquires TE eight years later. The CEO was still employed at the acquisition date and will receive the additional payment under the existing contract.
- IE272. In this example, TE entered into the employment agreement before the negotiations of the combination began, and the purpose of the agreement was to obtain the services of CEO. Thus, there is no evidence that the agreement was arranged primarily to provide benefits to AE or the combined entity. Therefore, the liability to pay CU5 million is included in the application of the acquisition method.
- IE273. In other circumstances, TE might enter into a similar agreement with CEO at the suggestion of AE during the negotiations for the acquisition. If so, the primary purpose of the agreement might be to provide severance pay to CEO, and the agreement may primarily benefit AE or the combined entity rather than TE or its former owners. In that situation, AE accounts for the liability to pay CEO in its post-combination financial statements separately from application of the acquisition method.

#### **Subsequent Measurement of Transfers, Concessionary Loans and Similar Benefits Received by an Acquirer or an Acquired Operation on the Basis of Criteria that may Change as a Result of an Acquisition**

##### *Illustrating the Consequences of Applying Paragraphs 114 and AG109–AG111 of PBE IPSAS 40.*

- IE274. The following example illustrates the subsequent accounting for a transfer received by an acquirer on the basis of criteria that may change as a result of an acquisition.
- IE275. On 1 January 20X6, a national government provides an annual grant to those municipalities where their revenue per head of population is below a threshold. On 1 June 20X3 AE, a municipality, acquires TE, a shopping complex that will generate revenue for AE. AE had previously received a grant of CU500, based on its revenue per head of population.
- IE276. As a result of its acquisition of TE on 1 June 20X3, the revenue per head of population of AE increases above the threshold that the government had set when allocating grants.
- IE277. On 1 July 20X3, the national government requires AE to repay a portion (CU100) of the grant previously received by AE. AE recognises a liability and an expense of CU100 on 1 July 20X3.



**Disclosure Requirements Relating to Acquisitions**

*Illustrating the Consequences of Applying the Disclosure Requirements in Paragraphs 119–125 of PBE IPSAS 40.*

IE278. The following example illustrates some of the disclosure requirements relating to acquisitions; it is not based on an actual transaction. The example assumes that AE is a public sector entity with responsibility for healthcare in its region and that TE is a listed entity. The illustration presents the disclosures in a tabular format that refers to the specific disclosure requirements illustrated.

**Paragraph reference**

- 120(a)–(d) On 30 June 20X2 AE acquired 75 percent of the ordinary shares of TE and obtained control of TE. An analysis of the economic substance of the combination confirms the transaction is an acquisition. TE is a provider of medical supplies. As a result of the acquisition, AE is expected to deliver improved healthcare to its residents. It also expects to reduce costs through economies of scale.
- 120(e) The goodwill of CU2,500 arising from the acquisition consists largely of the synergies and economies of scale expected from combining the operations of AE and TE.
- 120(k) None of the goodwill recognised is expected to be deductible for income tax purposes. The following table summarises the consideration paid for TE and the amounts of the assets acquired and liabilities assumed recognised at the acquisition date, as well as the fair value at the acquisition date of the non-controlling interest in TE.

<b>As at 30 June 20X2</b>		<b>CU</b>
	<b>Consideration</b>	
120(f)(i)	Cash	11,000
120(f)(iii); 120(g)(i)	Contingent consideration arrangement	1,000
120(f)	<b>Total consideration transferred</b>	12,000
120(m)	<b>Acquisition-related costs</b> (included in selling, general and administrative expenses in AE's statement of comprehensive revenue and expense for the year ended 31 December 20X2)	1,250
120(i)	<b>Recognised amounts of identifiable assets acquired and liabilities assumed</b>	
	Financial assets	3,500
	Inventory	1,000
	Property, plant and equipment	10,000
	Identifiable intangible assets	3,300
	Financial liabilities	(4,000)
	Contingent liability	(1,000)
	Total identifiable net assets	12,800
120(p)(i)	<b>Non-controlling interest in TE</b>	(3,300)
	<b>Goodwill</b>	2,500
		12,000

**Paragraph  
reference**

- 120(f)(iii)  
120(g)  
124(b)
- The contingent consideration arrangement requires AE to pay the former owners of TE 5 percent of the revenues of XE, an unconsolidated equity investment owned by TE, in excess of CU7,500 for 20X3, up to a maximum amount of CU2,500 (undiscounted).
- The potential undiscounted amount of all future payments that AE could be required to make under the contingent consideration arrangement is between CU0 and CU2,500.
- The fair value of the contingent consideration arrangement of CU1,000 was estimated by applying an income approach. Key assumptions include a discount rate range of 20–25 percent and assumed probability-adjusted revenues in XE of CU10,000–20,000.
- As of 31 December 20X2, neither the amount recognised for the contingent consideration arrangement, nor the range of outcomes or the assumptions used to develop the estimates had changed.
- 120(h)
- The fair value of the financial assets acquired includes receivables with a fair value of CU2,375. The gross amount due under the contracts is CU3,100, of which CU450 is expected to be uncollectible.
- 124(a)
- The fair value of the acquired identifiable intangible assets of CU3,300 is provisional pending receipt of the final valuations for those assets.
- 120(j)  
124(c)  
PBE IPSAS 19  
paras 97, 98
- A contingent liability of CU1,000 has been recognised for expected warranty claims on products sold by TE during the last three years. We expect that the majority of this expenditure will be incurred in 20X3 and that all will be incurred by the end of 20X4. The potential undiscounted amount of all future payments that AE could be required to make under the warranty arrangements is estimated to be between CU500 and CU1,500. As of 31 December 20X2, there has been no change since 30 June 20X2 in the amount recognised for the liability or any change in the range of outcomes or assumptions used to develop the estimates.
- 120(p)
- The fair value of the non-controlling interest in TE, a listed entity, was measured using the closing market price of TE's ordinary shares on the acquisition date.
- 120(r)(i)
- The revenue included in the consolidated statement of comprehensive revenue and expense since 30 June 20X2 contributed by TE was CU4,090. TE also contributed profit of CU1,710 over the same period.
- 120(r)(ii)
- Had TE been consolidated from 1 January 20X2 the consolidated statement of comprehensive revenue and expense would have included revenue of CU27,670 and profit of CU12,870.

In considering the disclosures related to an acquisition, an entity may find it helpful to refer to the discussion of materiality in PBE IPSAS 1.

## Comparison with IPSAS 40

PBE IPSAS 40 *PBE Combinations* is drawn from IPSAS 40 *Public Sector Combinations*.

The significant differences between PBE IPSAS 40 and IPSAS 40 are:

- (a) PBE Standards require the presentation of a statement of comprehensive revenue and expense. IPSAS require the presentation of a statement of financial performance.
- (b) PBE IPSAS 40 treats the existence or absence of consideration as a single indicator of whether a combination is an amalgamation or an acquisition. IPSAS 40 identifies three indicators relating to consideration. PBE IPSAS 40 reclassifies scenario 6 in the illustrative examples from an amalgamation to an acquisition.
- (c) PBE IPSAS 40 modifies the definitions of equity interests and owners to broadly align with PBE IFRS 3 *Business Combinations*. The revised definitions reflect the New Zealand public benefit entities' broader view of equity interests and owners.
- (d) PBE IPSAS 40 uses the terms "new reporting entity" and "continuing reporting entity" to identify the requirements that apply in various circumstances. IPSAS 40 uses the terms "new entity" and "continuing entity".
- (e) PBE IPSAS 40 contains additional guidance on how to apply the modified pooling interests method if one of the combining operations had not applied PBE Standards prior to the amalgamation. PBE IPSAS 40 also requires the resulting entity to recognise all assets and liabilities of the combining operations in accordance with PBE Standards, irrespective of whether or not the combining operations had recognised the assets and liabilities prior to the amalgamation. IPSAS 40 does not permit the recognition of previously unrecognised assets and liabilities of the combining operations.
- (f) PBE IPSAS 40 requires the continuing reporting entity to provide comparatives in the first set of financial statements following an amalgamation and clarifies that a new reporting entity shall not present comparatives. PBE IPSAS 40 also clarifies that combining operations provide historical information up to the amalgamation date. IPSAS 40 permits but does not require that a resulting entity present comparative information.
- (g) PBE IPSAS 40 contains guidance on assessing whether one entity has obtained control of another operation. IPSAS 40 does not have such guidance.
- (h) PBE IPSAS 40 permits retrospective application of the Standard for some first-time adopters of PBE Standards. PBE IPSAS 40 also clarifies that restatement of combinations that occurred before the date the Standard is applied is prohibited. IPSAS 40 does not permit retrospective application.
- (i) PBE IPSAS 40 contains additional guidance and an additional illustrative example on voluntary combinations not under common control.
- (j) PBE IPSAS 40 omits some requirements in IPSAS 40 on the recognition and measurement of income taxes following acquisitions and amalgamations and how to account for taxes forgiven as a result of a combination.
- (k) PBE IPSAS 40 does not permit the recognition of goodwill related to the acquisition of a non-cash-generating operation. IPSAS 40 permits the recognition of goodwill related to the acquisition of a non-cash-generating operation.

## History of Amendments

PBE IPSAS 40 *PBE Combinations* was issued in [date].

This table lists the pronouncements establishing and substantially amending PBE IPSAS 40.

<b>Pronouncements</b>	<b>Date approved</b>	<b>Early operative date</b>	<b>Effective date (annual reporting periods... on or after ...)</b>
PBE IPSAS 40 <i>PBE Combinations</i>	[date]	Early application is permitted	[date]